

ABSTRACT

This user's guide describes the correct use of the MYC0409-NA-120WD, and MYC0409-NA-200WD test boards and explains the test points on the boards.

Table of Contents

Description	2	MYC0409-NA-120WD-EVM Bill of Materials (BOM)	10
Performance summary	3	MYC0409-NA-120WD-EVM Schematic	10
Quick Start Guide	3	MYC0409-NA-200WD-EVM Bill of Materials (BOM)	11
Evaluation overview	4	MYC0409-NA-200WD-EVM Schematic	12
Terminal functions	4	Notices.....	13
Power Input and Output Descriptions	4	 CAUTION	13
Test Point Descriptions	4	Sales Contact.....	13
EVM connection	5	Disclaimers	13
MYC0409-NA-120WD-EVM Start-Up Procedure	5	Copyright and Trademark.....	13
MYC0409-NA-200WD-EVM Start-Up Procedure	5		
Performance Data.....	6		

Description

This EVM (Evaluation Module) features the MYC0409-NA standalone charge pump module configured for operation with an input voltage range of 20 to 60V. The output voltage for the MYC0409-NA-120WD-EVM and MYC0409-NA-200WD-EVM is a fixed divide-by-4 conversion ratio from the input voltage.

Input and output capacitors are mounted on the board to accommodate the entire range of input and output voltages. Each EVM requires a separate implementation board for measuring voltage, efficiency, power dissipation, and load regulation.

Detailed application information for MYC0409-NA can be found in the datasheet.

この EVM (評価モジュール) は、20~60V の入力電圧範囲で動作するように設定された MYC0409-NA スタンドアローンチャージポンプモジュールとなります。MYC0409-NA-120WD-EVM と MYC0409-NA-200WD-EVM の出力電圧は入力電圧の 4 分の 1 に固定された変換比です。

入力および出力コンデンサは、全範囲の入力および出力電圧に対応するために基板上に取り付けられています。電圧、効率、消費電力、および負荷調整を測定するためには各 EVM を実装するボードが必要となります。

MYC0409-NA の詳細なアプリケーション情報はデータシートでご確認いただけます。

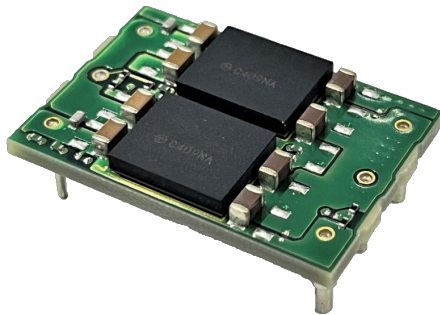

(A) MYC0409-NA-120WD-EVM
(1/16 Brick、LxWxH: 22.8mm x 33.0mm x 7.7mm)

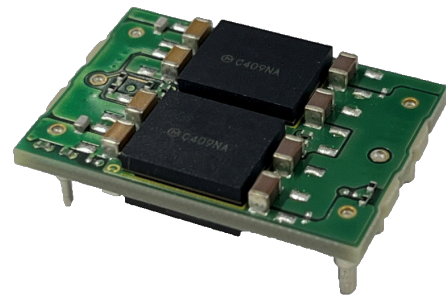

(B) MYC0409-NA-200WD-EVM
(1/16 Brick、LxWxH: 22.8mm x 33.0mm x 7.7mm)

Figure 1. Evaluation Board

Performance summary

Table 1. Performance summary

PARAMETER	SYMBOL	CONDITIONS		MIN	TYPICAL	MAX	UNITS
INPUT SUPPLY							
Input voltage range	V _{IN}	MYC0409-NA-120WD-EVM		20	-	60	V
		MYC0409-NA-200WD-EVM					
OUTPUT							
Efficiency Full Load	EFF	V _{in} =48V, I _{OUT} =10A	MYC0409-NA-120WD-EVM	-	95.0	-	%
		V _{in} =48V, I _{OUT} =18A	MYC0409-NA-200WD-EVM	-	95.0	-	
Switching Frequency	F _{SW}	MYC0409-NA-120WD-EVM MYC0409-NA-200WD-EVM		-	270	-	kHz
Output Current (Continuous)	I _{OUT}	MYC0409-NA-120WD-EVM		-	-	10	A
		MYC0409-NA-200WD-EVM		-	-	19	
Output Current (Start-up)(1)	I _{OUT}	MYC0409-NA-120WD-EVM		-	-	20	mA
		MYC0409-NA-200WD-EVM		-	-	20	
V _{OUT} Voltage	V _{OUT}	I _{LOAD} =No load, DC	MYC0409-NA-120WD-EVM	-	V _{IN} /4	-	V
			MYC0409-NA-200WD-EVM				
Notes: (1) Load currents may cause start-up failure due to Soft-start timeout fault. Devices supplied power from this device should be started up after the PGOOD signal becomes high state							

Quick Start Guide

Figure 2. Highlights the user interface items associated with the EVM.

The *V_{IN}* Power terminals are used for connection to the host input supply and the *V_{OUT}* Power terminals are used for connection to the load.

Evaluation overview

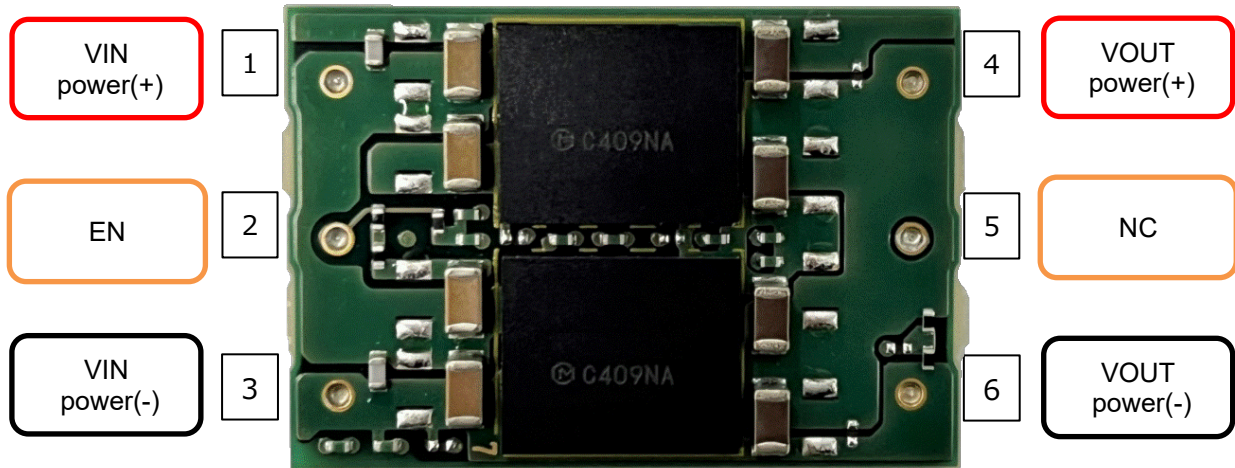

(A) MYC0409-NA-120WD-EVM and (B) MYC0409-NA-200WD-EVM

Figure 2. Evaluation Board User Interface (Top view)

Terminal functions

Table 2. Terminal functions

FUNCTION/TERMINAL	DESCRIPTION
VIN power (+/-)	Power input pin and Input Ground pin.
VOUT power (+/-)	Power output pin and output Ground pin.
EN	ON/OFF pin. If this is high level, the module operates. (This pin is pulled up internally)
NC	Do not connect to this pin

(A) MYC0409-NA-120WD-EVM and (B) MYC0409-NA-200WD-EVM

Power Input and Output Descriptions

The VIN power terminal is used to connect to the input supply, and the VOUT power terminal is used to connect to the load.

Caution: Do not use the sense(+) and sense(-) terminals of MYC0409-NA-50WR-EVM as output load connection points. The PCB traces connecting to these sense terminals are not designed to support high currents. High currents may cause damage the PCB traces.

Test Point Descriptions

The sense(+) and sense(-) test points for VOUT, located near the MYC0409-NA-50WR-EVM power terminal are intended to be used as voltage monitoring points where voltmeters can be connected to measure VOUT.

EVM connection

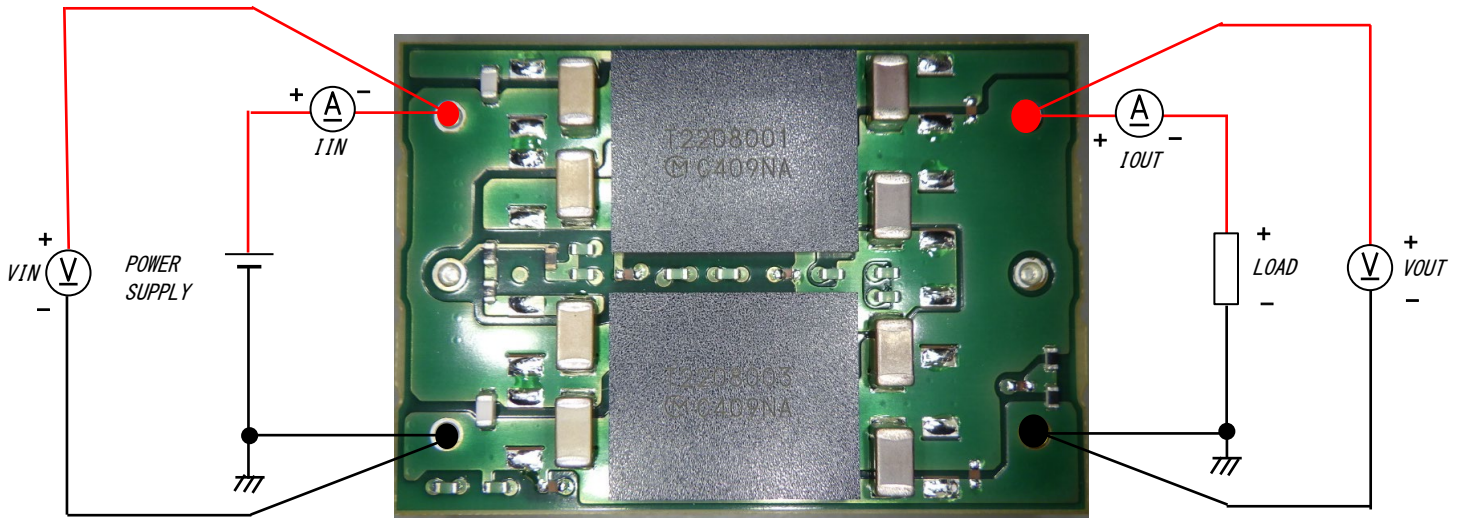

(A) MYC0409-NA-120WD-EVM and (B) MYC0409-NA-200WD-EVM

Figure 3. EVM Connection

MYC0409-NA-120WD-EVM Start-Up Procedure

1. Set the power supply current limit to at least 4A. Connect the power supply to VIN power(+) and VIN power(-).
2. Connect one electronic load with more than 10A capacity between Vout power(+) and Vout power(-).
3. Set input voltage to 48V and turn it on.
4. Measure the output voltages. VOUT should be $V_{in}/4=12V$.
5. Slowly increase the load current while monitoring the output voltages. The outputs should drop because this module is just divider.

MYC0409-NA-200WD-EVM Start-Up Procedure

1. Set the power supply current limit to at least 6A. Connect the power supply to VIN power(+) and VIN power(-).
2. Connect one electronic load with more than 19A capacity between Vout power(+) and Vout power(-).
3. Set input voltage to 48V and turn it on.
4. Measure the output voltages. VOUT should be $V_{in}/4=12V$.
5. Slowly increase the load current while monitoring the output voltages. The outputs should drop because this module is just divider.

Performance Data

Figure 4. through Figure 10. demonstrate the MYC0409-NA-120WD-EVM performance.
Figure 12. through Figure 19. demonstrate the MYC0409-NA-200WD-EVM performance.
The following test results show the typical performance of the evaluation board.

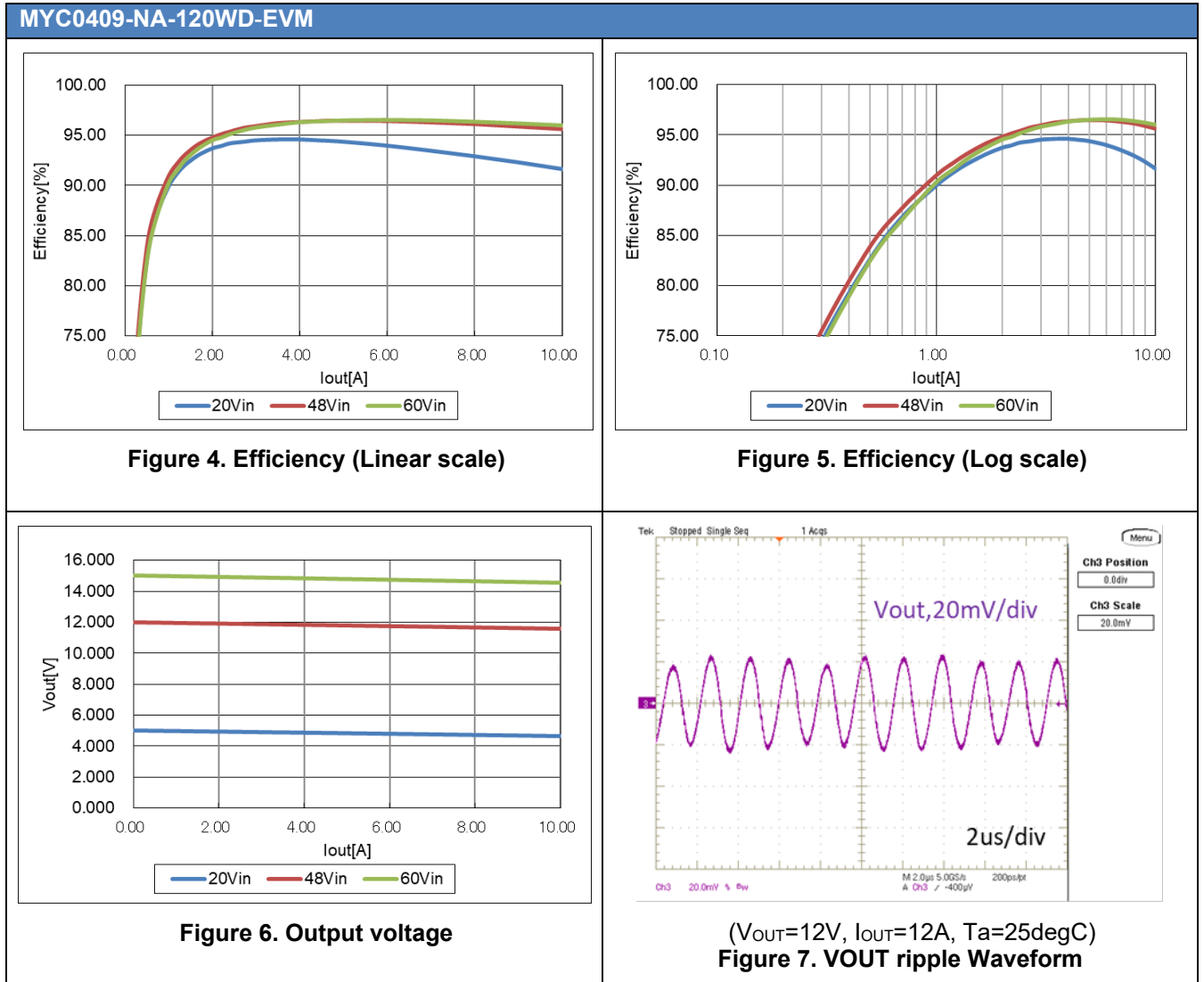

MYC0409-NA-120WD-EVM

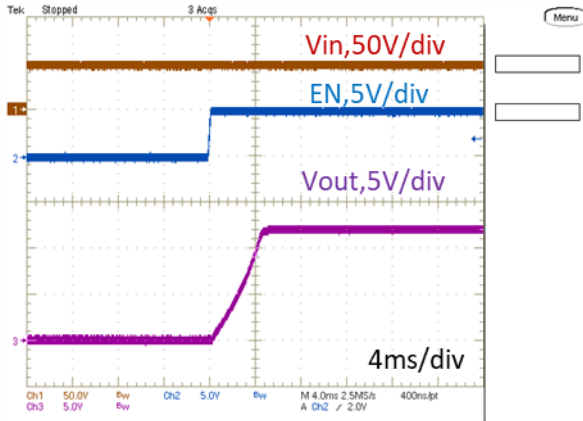

($V_{OUT}=12V$, $I_{OUT}=12A$, $T_a=25\text{degC}$)
Figure 8. Start-up Waveform

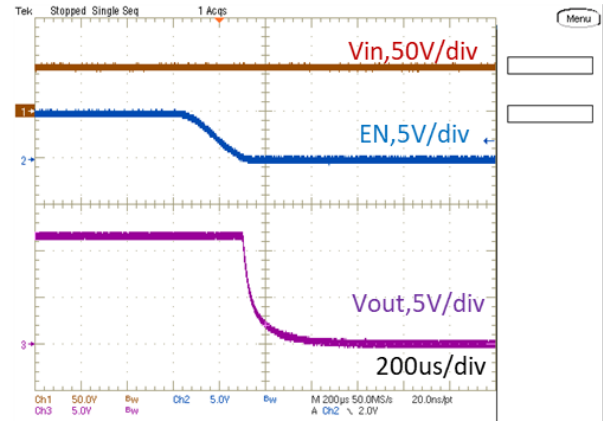

($V_{OUT}=12V$, $I_{OUT}=12A$, $T_a=25\text{degC}$)
Figure 9. Shutdown Waveform

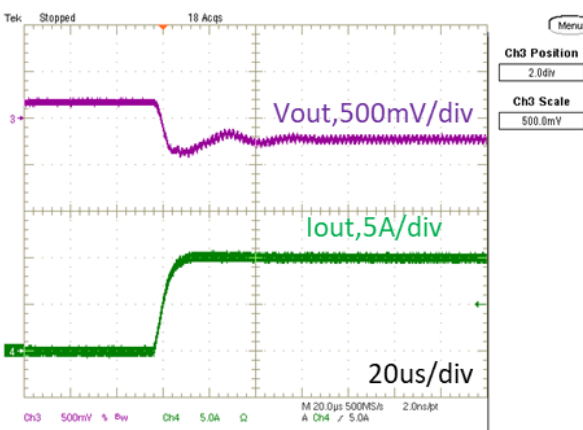

($V_{OUT}=12V$, $I_{OUT}=0A$ to $12A$, $T_a=25\text{degC}$)
Figure 10. Load transient response Waveform

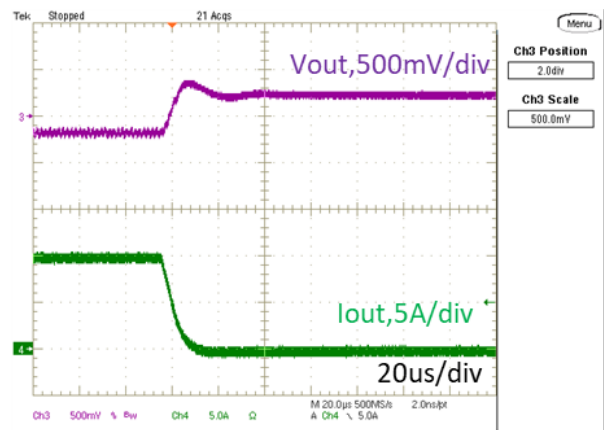

($V_{OUT}=12V$, $I_{OUT}=12A$ to $0A$, $T_a=25\text{degC}$)
Figure 11. Load transient response Waveform

MYC0409-NA-200WD-EVM

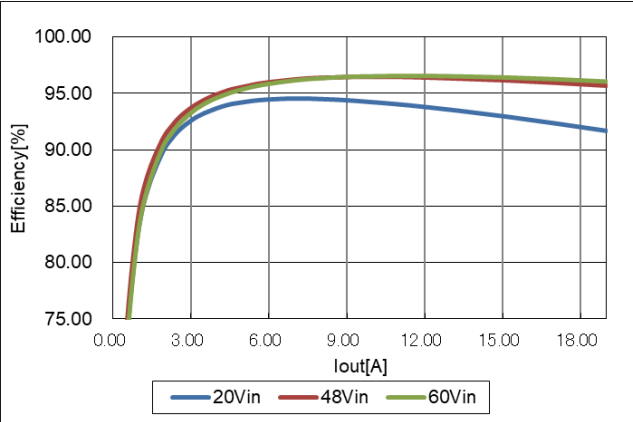

Figure 12. Efficiency (Linear scale)

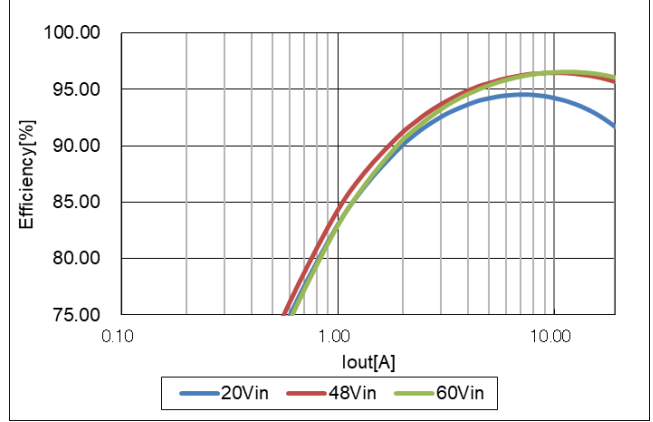

Figure 13. Efficiency (Log scale)

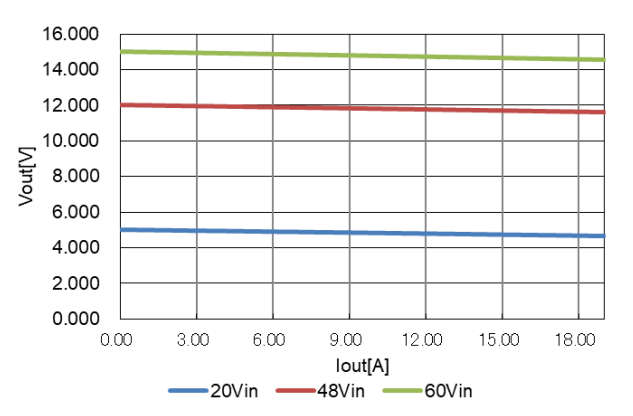
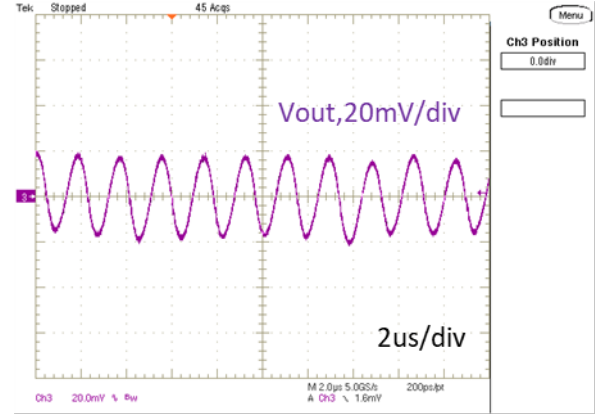
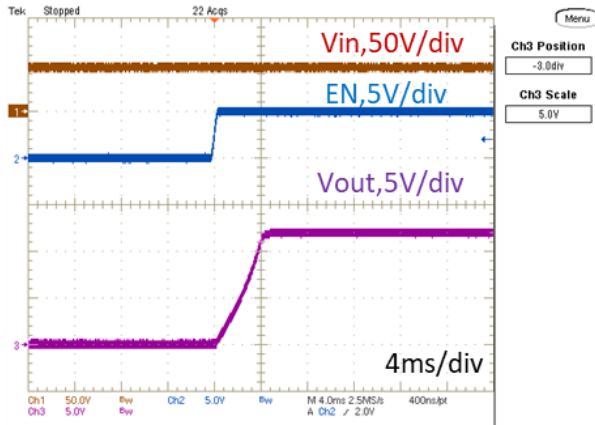

Figure 14. Output voltage



(VOUT=12V, IOUT=19A, Ta=25degC)
Figure 15. VOUT ripple Waveform

MYC0409-NA-200WD-EVM



($V_{OUT}=12V$, $I_{OUT}=19A$, $T_a=25degC$)
Figure 16. Start-up Waveform

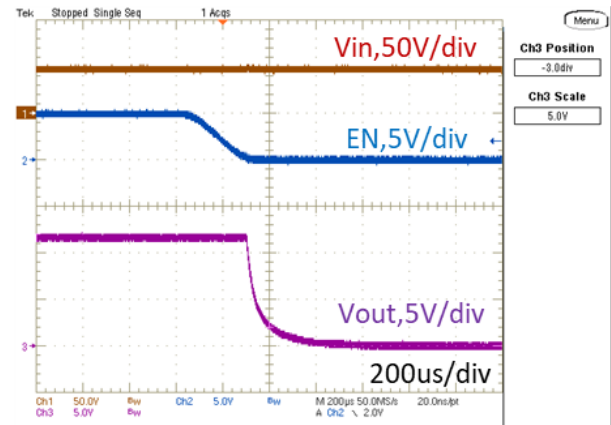

($V_{OUT}=12V$, $I_{OUT}=19A$, $T_a=25degC$)
Figure 17. Shutdown Waveform

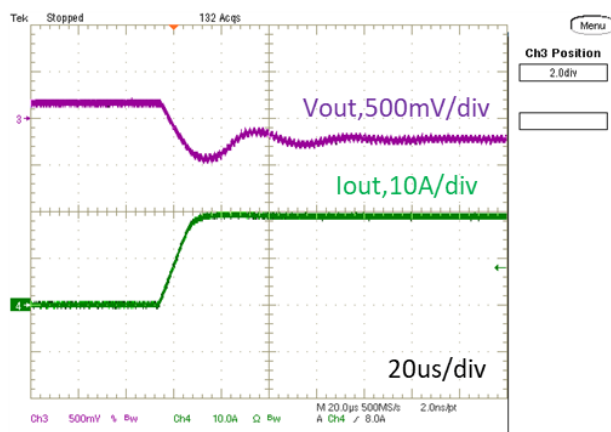

($V_{OUT}=12V$, $I_{OUT}=0A$ to $19A$, $T_a=25degC$)
Figure 18. Load transient response Waveform

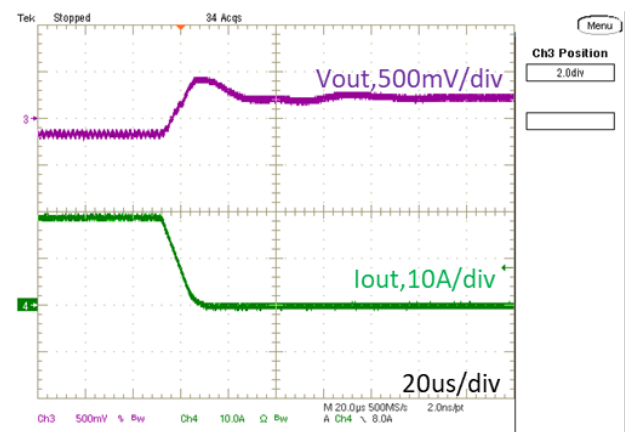

($V_{OUT}=12V$, $I_{OUT}=19A$ to $0A$, $T_a=25degC$)
Figure 19. Load transient response Waveform

MYC0409-NA-120WD-EVM Bill of Materials (BOM)

Table 3. MYC0409-NA-120WD-EVM Bill of materials

REFERENCE	QTY	VALUE	DESCRIPTION	SIZE	PART NUMBER	MANUFACTURER
C1,C2,C203,C204	4	4.7uF	Input Capacitor 4.7μF, 100V,+/-10%, X7S	1206	GRM31CC72A475KE11	Murata
C5,C205	2	1000pF	Input Capacitor 1000pF, 100V,+/-5%, CH	0603	GRM1882C2A102JA01D	Murata
C6, C7,C206,C207	4	22uF	Output Capacitor 22μF, 25V,+/-20%, X7S	1206	GRM31CC71E226ME15	Murata
C11	1	0.01uF	Pull down Capacitor for Enable function 0.01μF, 50V,+/-10%, X7S	0402	GRM155R71H103KA88D	KOA
R9	1	10kOhm	Leakage current countermeasures 5%, 0.1W	0402	RK73B1ETTP103J	KOA
R10, R13	2	12KOhm	Pull down resistor for Enable function 5%, 0.1W	0402	RK73B1ETTP123J	KOA
R14,R15	2	100kOhm	Pull up resistor for Enable function 5%, 0.1W	0402	RK73B1ETTP104J	KOA
R7,R8,R208	2	0Ohm	Jumper	0402	RK73Z1ETTP	KOA
M1	2		Power module		MYC0409-NA	Murata

MYC0409-NA-120WD-EVM Schematic

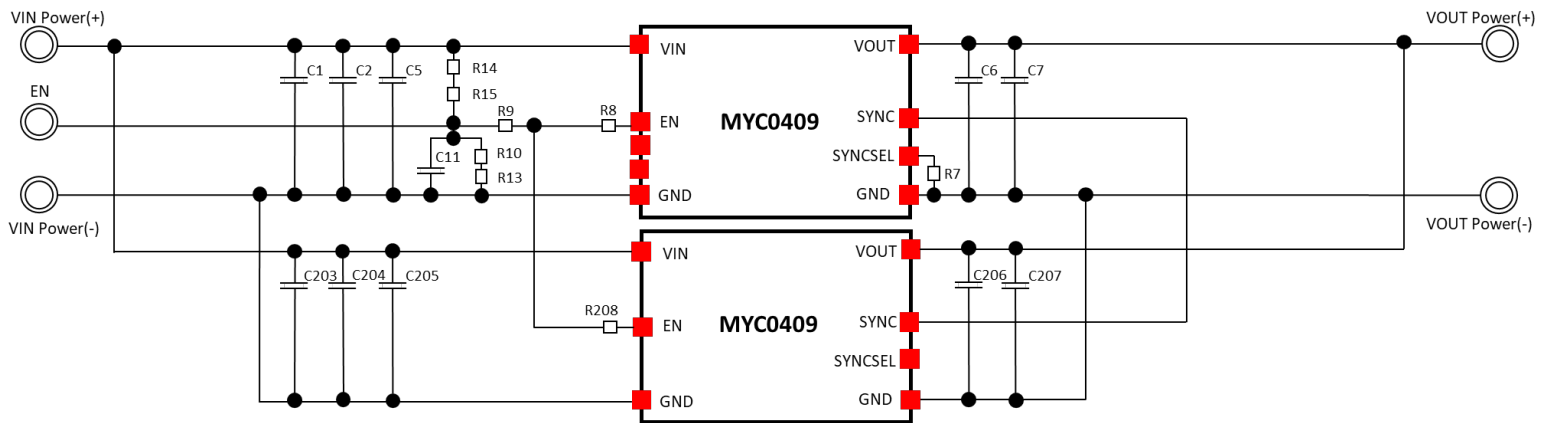

Figure 20. MYC0409-NA-120WD-EVM schematic

MYC0409-NA-200WD-EVM Bill of Materials (BOM)
Table 4. MYC0409-NA-200WD-EVM Bill of materials

REFERENCE	QTY	VALUE	DESCRIPTION	SIZE	PART NUMBER	MANUFACTURER
C1,C2, C203,C204, C301,C302 C401,C402	8	4.7uF	Input Capacitor 4.7μF, 100V,+/-10%, X7S	1206	GRM31CC72A475KE11	Murata
C5,C205, C305,C405	4	1000pF	Input Capacitor 1000pF, 100V,+/-5%, CH	0603	GRM1882C2A102JA01D	Murata
C6, C7, C206,C207, C306,C307, C406,C407	8	22uF	Output Capacitor 22μF, 25V,+/-20%, X7S	1206	GRM31CC71E226ME15	Murata
C11	1	0.01uF	Pull down Capacitor for Enable function 0.01μF, 50V,+/-10%, X7S	0402	GRM155R71H103KA88D	KOA
R9	1	10kOhm	Current Limiting Resistor 5%, 0.1W	0402	RK73B1ETTP103J	KOA
R10, R13	2	12KOhm	Pull down resistor for Enable function 5%, 0.1W	0402	RK73B1ETTP123J	KOA
R14,R15	2	100kOhm	Pull up resistor for Enable function 5%, 0.1W	0402	RK73B1ETTP104J	KOA
R7,R8,R208, R308,R408	4	0Ohm	Jumper	0402	RK73Z1ETTP	KOA
M1	4		Power module		MYC0409-NA	Murata

MYC0409-NA-200WD-EVM Schematic

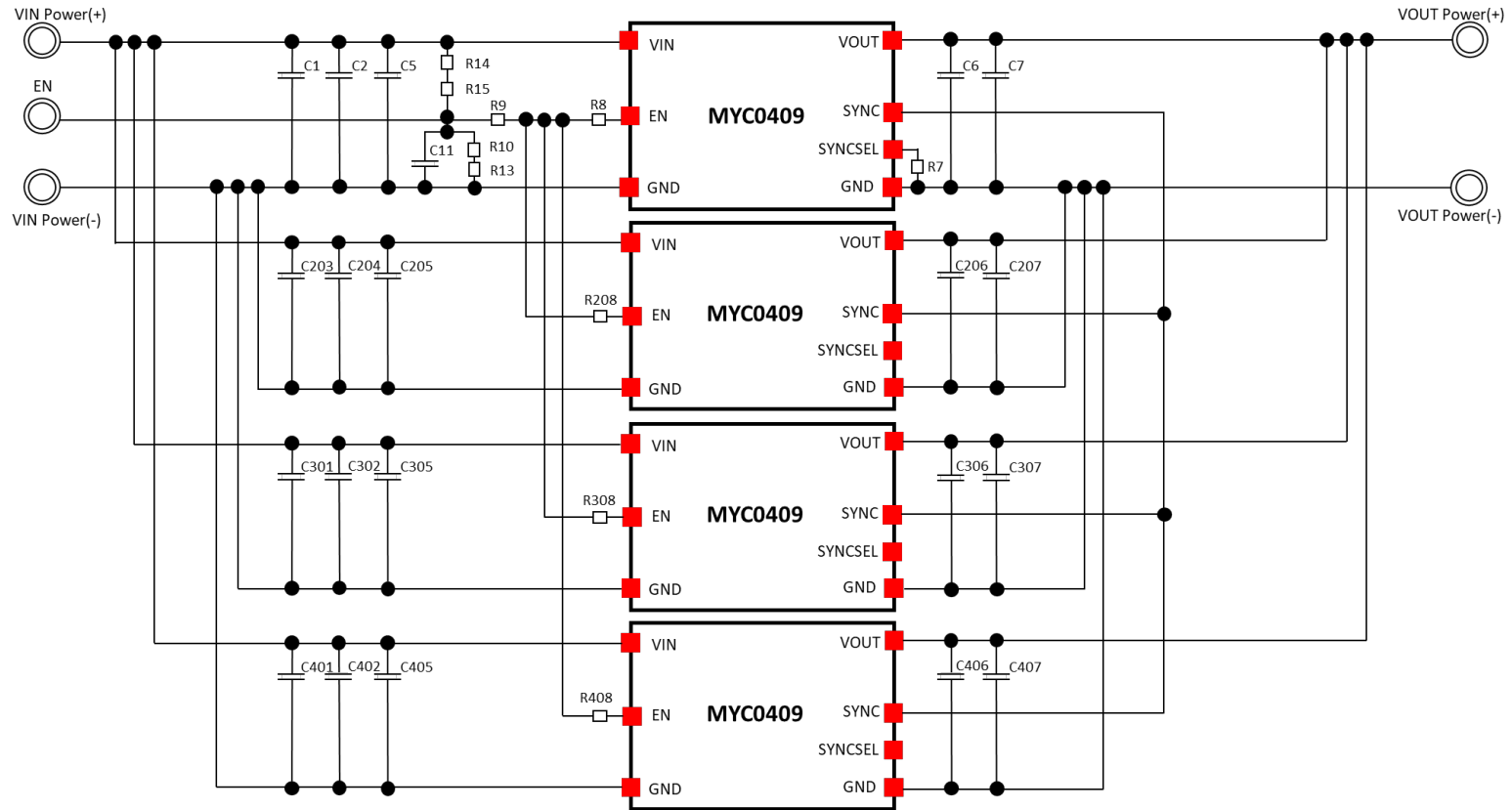

Figure 21. MYC0409-NA-200WD-EVM schematic

Notices

CAUTION

1. EVMs are not finished products. Murata delivers EVM for use in a research and development evaluation purpose only.
2. Please make sure that your product has been evaluated and confirmed to your specifications when our product is used in your product.
3. All the items and parameters in this approval sheet for product specification are based on the premise that our product is used for the purpose, under the condition and in the environment agreed upon between you and us. You are requested not to use our product in a manner deviating from such agreement.
4. If you have any concerns about materials other than those listed in the RoHS directive, please contact us.
5. Be sure to provide an appropriate fail-safe functionality in your product to prevent secondary damage that could be caused by the abnormal function or failure of our product.
6. Do not allow our product to be exposed to excess moisture under any circumstances.

Sales Contact

For additional information, contact Sales at muratalpdc@murata.com.

Disclaimers

The information in this document is believed to be reliable. However, Murata assumes no liability for the use of this information. Use shall be entirely at the user's own risk. No patent rights or licenses to any circuits described in this document are implied or granted to any third party. Murata's products are not designed or intended for use in devices or systems intended for surgical implant, or in other applications intended to support or sustain life, or in any application in which the failure of the Murata product could create a situation in which personal injury or death might occur. Murata assumes no liability for damages, including consequential or incidental damages, arising out of the use of its products in such applications.

Copyright and Trademark

©2023 Murata Manufacturing Co., Ltd. All rights reserved.



This product is subject to the following [operating requirements](#) and the [Life and Safety Critical Application Sales Policy](#):
Refer to: <https://power.murata.com/en/requirements>

Murata Manufacturing Co., Ltd makes no representation that the use of its products in the circuits described herein, or the use of other technical information contained herein, will not infringe upon existing or future patent rights. The descriptions contained herein do not imply the granting of licenses to make, use, or sell equipment constructed in accordance therewith.