

# DC-DC Converter Application Manual

## MPDTH12050Y\*\*

### 6-A, 12-V Input Non-Isolated DDR/QDR Memory Bus Termination Module



NOMINAL SIZE = 22.1 mm x 12.57 mm

#### Features

- VTT Bus Termination Output (Output Track the System Vref)
- 6-A Output Current
- 12-V Input Voltage
- DDR and QDR Compatible
- Efficiencies up to 84 %
- 50 W/in<sup>3</sup> Power Density
- On/Off Inhibit(for Vtt Standby)
- Under-Voltage Lockout
- Output Over-Current Protection (Non-Latching, Auto-Reset)
- Operating Temp: -40 to +85 °C
- Point-of-Load Alliance Compatible

#### Description

The MPDTH12050Y are a series of ready-to-use switching regulator modules from Murata designed specifically for bus termination in DDR and QDR memory applications. Operating 12-V input, the module generates a VTT output that will source or sink up to 6 A of current to accurately track their Vref input. VTT is the required bus termination supply voltage, and Vref is the reference voltage for the memory and chipset bus receiver comparators. Vref is usually set to half the VDDQ power supply voltage. The MPDTH12050Y employs an actively switched synchronous rectifier output to provide state-of-the-art stepdown switching conversion.

The products are small in size (22.1mm × 12.57mm), and are an ideal choice where space, performance, and high efficiency are desired, along with the convenience of a ready-to-use module.

Operating features include an on/off inhibit and output over-current protection (source mode only). The on/off inhibit feature allows the VTT bus to be turned off to save power in a standby mode of operation. To ensure tight load regulation, an output remote sense is also provided. Package options include both throughhole and surface mount configurations.

#### Pin Configuration

Pin	Function
1	GND
2	Vref
3	Vin
4	Inhibit
5	No Connect
6	VTT

#### Standard Application

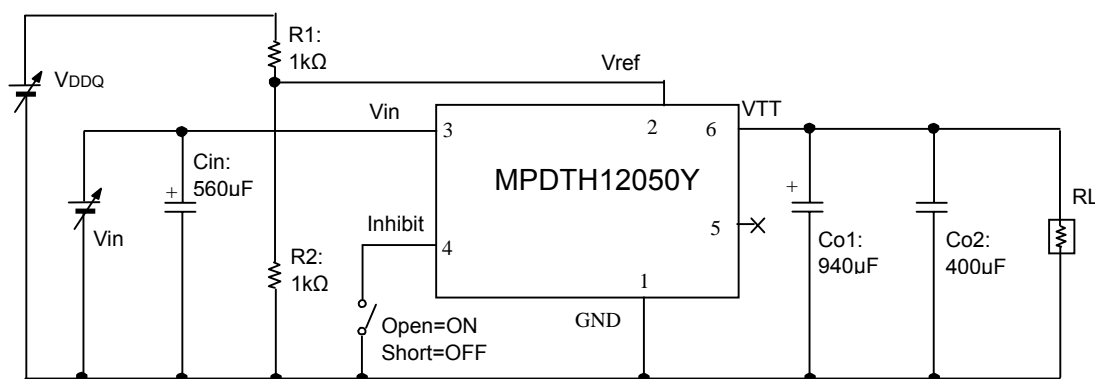

Cin : Required 560µF, Capacitor

Co1 : Required 940µF, Low-ESR Electrolytic Capacitor

Co2 : Ceramic Capacitor for Optimum response, 400µF

#### Note:

1. This datasheet is downloaded from the website of Murata Manufacturing co., ltd. Therefore, it's specifications are subject to change or our products in it may be discontinued without advance notice. Please check with our sales representatives or product engineers before ordering.
2. This datasheet has only typical specifications because there is no space for detailed specifications. Therefore, please approve our product specifications or transact the approval sheet for product specifications before ordering.

## 6-A, 12-V Input Non-Isolated DDR/QDR Memory Bus Termination Module

### Ordering Information

#### Output Voltage (MPDTH12050□xx)

Code	Voltage
Y	0.55V-1.8V(Adjustable)

#### Package Options (MPDTH12050x□□)

Code	Description
AH	Horiz. T/H
AS	SMD(*1)

**Notes** (1) Pb free (Sn-Ag-Cu) pin solder material.

### Pin Description

**Vin:** The positive input voltage power node to the module, which is referenced to common *GND*.

**VTT:** This is the regulated power output from the module with respect to the *GND* node, and the tracking termination supply for the application data and address buses. It is precisely regulated to the voltage applied to the module's *Vref* input, and is active about 20 ms after a valid input source is applied to the module. Once active it will track the voltage applied at *Vref*.

**GND:** This is the common ground connection for the *VIN* and *VTT* power connections. It is also the 0 VDC reference for the control inputs.

**Inhibit:** The Inhibit pin is an open-collector/drain negative logic input that is referenced to *GND*. Applying a low-level ground signal to this input turns off the output voltage, *VTT*. Although the module is inhibited, a voltage, *VDDQ* will be present at the output terminals, fed through the DDR memory. When the Inhibit is active, the input current drawn by the regulator is significantly reduced. If the Inhibit pin is left open circuit, the module will produce an output whenever a valid input source is applied. See the Typical DDR Application Diagram in the Application Information section for reference.

**Vref:** The module senses the voltage at this input to regulate the output voltage, *VTT*. The voltage at *Vref* is also the reference voltage for the system bus receiver comparators. It is normally set to precisely half the bus *Vref* 8 driver supply voltage ( $VDDQ + 2$ ), using a resistor divider. The Thevenin impedance of the network driving the *Vref* pin should not exceed 500  $\Omega$ . See the Typical DDR Application Diagram in the Application Information section for reference.

**Vo Sense:** The sense input allows the regulation circuit to compensate for voltage drop between the module and the load. For optimal voltage accuracy *Vo Sense* should be connected to *VTT*.

**No Connect:** No connection.

#### ⚠ Note:

1. This datasheet is downloaded from the website of Murata Manufacturing co., ltd. Therefore, it's specifications are subject to change or our products in it may be discontinued without advance notice. Please check with our sales representatives or product engineers before ordering.
2. This datasheet has only typical specifications because there is no space for detailed specifications. Therefore, please approve our product specifications or transact the approval sheet for product specifications before ordering.

## 6-A, 12-V Input Non-Isolated DDR/QDR Memory Bus Termination Module

### Environmental & Absolute Maximum Ratings (Voltages are with respect to GND)

Characteristics	Symbols	Conditions	Min	Typ	Max	Units
Control Input Voltage	Vref		-0.3	-	Vin+0.3	V
Operating Temperature Range	Ta	Over Vin Range	-40 (i)	-	85	°C
Storage Temperature	Ts		-40		125	°C
Solder Reflow Temperature	Treflow	Surface temperature of module body or pins			245 (ii)	°C

**Notes:** (i) For operation below 0 °C the external capacitors must have stable characteristics. Use either a low ESR tantalum, Os-Con, or ceramic capacitor.

(ii) During reflow of SMD package version do not elevate peak temperature of the module, pins or internal components above the stated maximum

### Electrical Specifications

(Unless otherwise stated, Ta =25°C, Vin =12 V, Vref =1.25 V, Cin =560µF, Co1 =940µF, Co2 =400µF, and Io =Iomax)

Characteristics	Symbols	Conditions	Min	Typ	Max	Units
Output Current	Io	Over ΔVref range	0	-	±6(1)	A
Input Voltage Range	Vin	Over Io Range	10.8(2)	-	13.2	V
Tracking range for Vref	ΔVref		0.55	-	1.8	V
Tracking tolerance to Vref	VTT-Vref	Over line, load and temperature Io=0A	-10	-	10	mV
Efficiency	η	Io=4A	-	84	-	%
Vo Ripple (pk-pk)	Vr	20 MHz bandwidth	-	20	-	mVpp
Short Circuit Protection	Io trip	Reset, Followed by Auto-Recovery	-	12	-	A
Load transient response	ttr ΔVtr	15 A/µs load step, from -1.5A to 1.5A Recovery Time Vo Deviation	- -	80 25	- 40	µsec mV
Rising UVLO Threshold	UVLOr	Vin Increasing	-	9.5	10.4	V
Falling UVLO Threshold	UVLOf	Vin Decreasing	8.1	9	-	V
Inhibit Control (pin4) Input High Voltage Input Low Voltage Input Low Current	VIH VIL IILinhibit	Referenced to GND Pin to GND	Vin-0.5 -0.2 -	- -	Open(2) 0.6 -	V µA
Input Standby Current	Iin inh	Inhibit (pin 3) to GND,	-	10	-	mA
Switching Frequency	Frq	Over Vin and Io Ranges	-	250	-	kHz
External Input Capacitance	Cin		560 (3)	-	-	µF
External Output Capacitance	Co1 Co2	Capacitance Non-Ceramic(ESR ≥ 4mΩ) Ceramic	940 (4) 0	400 (4)	3300(5) 600	µF
MTBF	MTBF	Per Bellcore TR-332 50 % stress, Ta =40°C, Ground Benign	6	-	-	10 <sup>6</sup> Hrs

**Notes:** (1) Rating is conditional on the module being directly soldered to a 4-layer PCB with 1 oz. copper. See the SOA curves or contact the factory for appropriate derating.

(2) This control pin has an internal pull-up to the input voltage VIN. If it is left open-circuit the module will operate when input power is applied.

A small low-leakage (<100 nA) MOSFET is recommended for control. For further information, consult the related application note.

(3) An input capacitor is required for proper operation. The capacitor must be rated for a minimum a minimum of 750 mA rms of ripple current.

(4) The minimum value of external output capacitance value ensures that VTT meets the specified transient performance requirements for the memory bus terminations. Lower values of capacitance may be possible when the measured peak change in output current is consistently less than 3 A.

(5) This is the calculated maximum. The minimum ESR limitation will often result in a lower value. Consult the application notes for further guidance

#### ⚠ Note:

1. This datasheet is downloaded from the website of Murata Manufacturing Co., Ltd. Therefore, its specifications are subject to change or our products in it may be discontinued without advance notice. Please check with our sales representatives or product engineers before ordering.
2. This datasheet has only typical specifications because there is no space for detailed specifications. Therefore, please approve our product specifications or transact the approval sheet for product specifications before ordering.

### 6-A, 12-V Input Non-Isolated DDR/QDR Memory Bus Termination Module

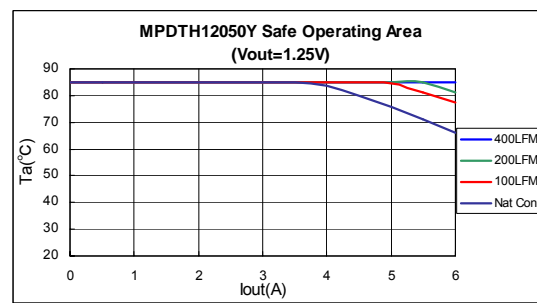
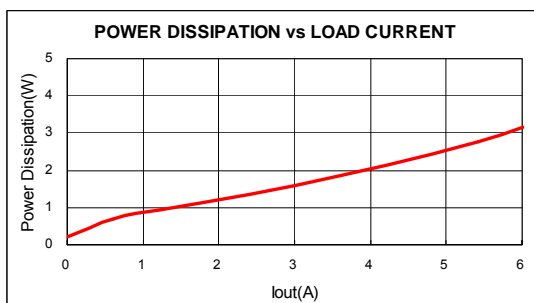
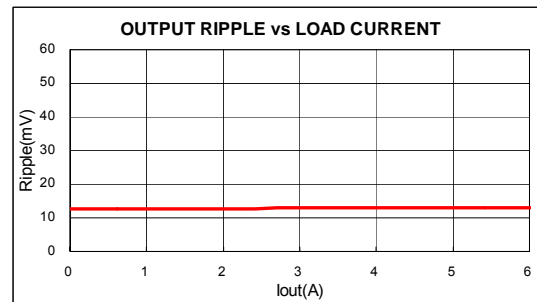
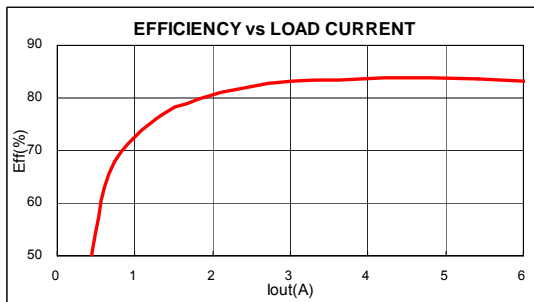

### Transient Performance for $\Delta 3A$ Load Change

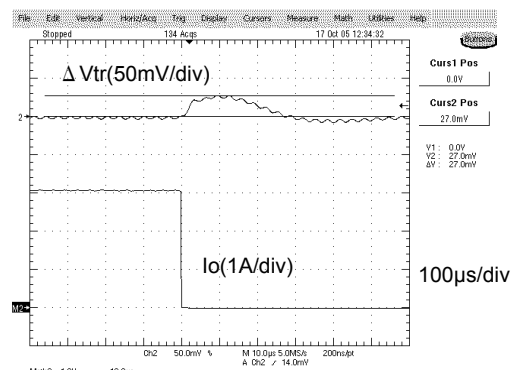
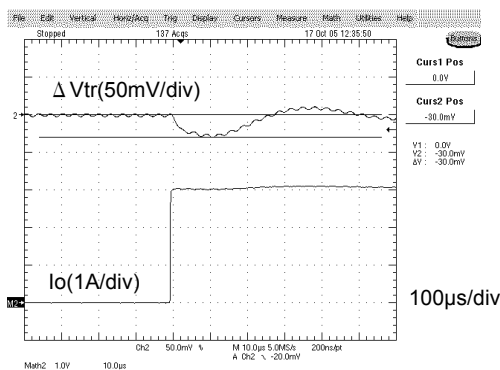

(1): The electrical characteristic data has been developed from actual products tested at 25°C. This data is considered typical for the converter.

Applies to Figure 1, Figure 2, and Figure 3.

(2): The temperature derating curves represent the conditions at which internal components are at or below the manufacturer's maximum operating temperatures. Derating limits apply to modules soldered directly to a 4 in x 4 in double-sided PCB with 1 oz. copper.

For surface mount packages (AS suffix), multiple vias (plated through holes) are required to add thermal paths around the power pins.

Please refer to the mechanical specification for more information. Applies to Figure 4.

#### ⚠ Note:

1. This datasheet is downloaded from the website of Murata Manufacturing co., ltd. Therefore, it's specifications are subject to change or our products in it may be discontinued without advance notice. Please check with our sales representatives or product engineers before ordering.
2. This datasheet has only typical specifications because there is no space for detailed specifications. Therefore, please approve our product specifications or transact the approval sheet for product specifications before ordering.

## MPDTH12050Y

## Typical DDR Application Diagram

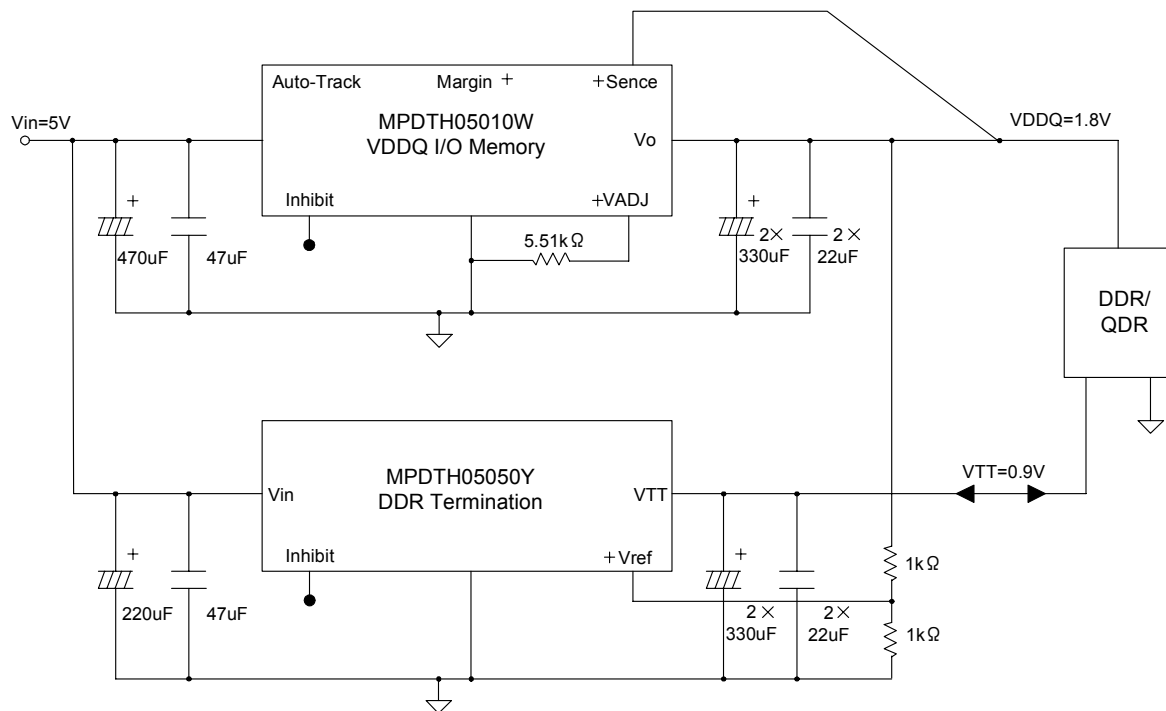
⚠ **Note:**

1. This datasheet is downloaded from the website of Murata Manufacturing co., ltd. Therefore, it's specifications are subject to change or our products in it may be discontinued without advance notice. Please check with our sales representatives or product engineers before ordering.
2. This datasheet has only typical specifications because there is no space for detailed specifications. Therefore, please approve our product specifications or transact the approval sheet for product specifications before ordering.

## MPDTH12050Y

## Capacitor Recommendations for the MPDTH12050Y DDR Power Module

### Input Capacitor

The recommended input capacitor(s) is determined by the 560 $\mu$ F minimum capacitance and 750 mArms minimum ripple current rating.

Ripple current, less than 100 m $\Omega$  equivalent series resistance (ESR), and temperature are the major considerations when selecting input capacitors. Unlike polymer tantalum, regular tantalum capacitors have a recommended minimum voltage rating of 2 $\times$ (maximum DC voltage + AC ripple). This is standard practice to ensure reliability.

For improved ripple reduction on the input bus, ceramic capacitors may be used to complement electrolytic types and achieve the minimum required capacitance.

### Output Capacitors

For applications with load transients (sudden changes in load current), regulator response will benefit from an external output capacitance. The recommended output capacitance of 940 $\mu$ F will allow the module to meet its transient response specification (see Electrical Specifications table). For most applications, high quality computer-grade aluminum electrolytic capacitors are adequate. These capacitors provide decoupling over the frequency range, 2 kHz to 150 kHz, and are suitable when ambient temperatures above 0 °C. Below 0 °C tantalum, ceramic or Os-Con type capacitors are recommended. When using one or more non-ceramic capacitors, the calculated equivalent ESR should not be lower than 4 m $\Omega$  (8 m $\Omega$  using the manufacturer's maximum ESR for a single capacitor). A list of preferred low-ESR type capacitors are listed on Table 1-1.

### Ceramic Capacitors

Above 150 kHz the performance of aluminum electrolytic capacitors becomes less effective. To further improve the reflected input ripple current or the output transient response, multilayer ceramic capacitors can be added. Ceramic capacitors have very low ESR and their resonant frequency is higher than the bandwidth of the regulator. When used on the output their combined ESR is not critical as long as the total value of ceramic capacitance does not exceed 300 $\mu$ F. Also, to prevent the formation of local resonance, do not place more than five identical ceramic capacitors in parallel with values of 10 $\mu$ F or greater.

### Tantalum Capacitors

Tantalum type capacitors can be used at both the input and output, and are recommended for applications where the ambient operating temperature can be less than 0 °C.

The AVX TPS, Sprague 593D/594/595 and Kemet T495/T510 capacitor series are recommended over many other tantalum types due to their higher rated surge, power dissipation, and ripple current capability. As a caution many general purpose tantalum capacitors have considerably higher ESR, reduced power dissipation and lower ripple current capability. These capacitors are also less reliable as they have reduced power dissipation and surge current ratings. Tantalum capacitors that do not have a stated ESR or surge current rating are not recommended for power applications.

When specifying Os-Con and polymer tantalum capacitors for the output, the minimum ESR limit is encountered before the maximum capacitance value is reached.

### Capacitor Table

Table 1 identifies the characteristics of capacitors from a number of vendors with acceptable ESR and ripple current (rms) ratings. The recommended number of capacitors required at both the input and output buses is identified for each capacitor type.

*This is not an extensive capacitor list. Capacitors from other vendors are available with comparable specifications. Those listed are for your reference. The RMS ripple current rating and ESR (at 100kHz) are critical parameters necessary to insure both optimum regulator performance and long capacitor life.*

### Designing for Very Fast Load Transients

The transient response of the DC/DC Converter has been characterized using a load transient with a di/dt of 1A/ $\mu$ s. The typical voltage deviation for this load transient is given in the data sheet specification table using the optional value of output capacitance. As the di/dt of a transient is increased, the response of a converter's regulation circuit ultimately depends on its output capacitor decoupling network. This is an inherent limitation with any DC/DC Converter once the speed of the transient exceeds its bandwidth capability. If the target application specifies a higher di/dt or lower voltage deviation, the requirement can only be met with additional output capacitor decoupling. In these cases special attention must be paid to the type, value and ESR of the capacitors selected.

If the transient performance requirements exceed that specified in the data sheet, or the total amount of load capacitance is above 3,300 $\mu$ F, the selection of output capacitors becomes more important.

#### ⚠ Note:

1. This datasheet is downloaded from the website of Murata Manufacturing co., ltd. Therefore, it's specifications are subject to change or our products in it may be discontinued without advance notice. Please check with our sales representatives or product engineers before ordering.
2. This datasheet has only typical specifications because there is no space for detailed specifications. Therefore, please approve our product specifications or transact the approval sheet for product specifications before ordering.

## MPDTH12050Y

Table 1-1; Input / Output Capacitors

Capacitor Vendor, Type Series (Style)	Capacitor Characteristics					Quantity		Vendor Number
	Working Voltage	Value (uF)	MAX.(ESR) at 100kHz	Max.Ripple at 85°C Current(Irms)	Physical Size(mm)	Input Bus	Output Bus	
Panasonic, Aluminum FC Radial	25	560	0.065	1205 mA	12.5×15	1	1	EEUFC1E561S
FK (SMD)	16	680	0.080	850 mA	10×10.2	1	2	EEVFK1C681P
United Chemi-Con PXA, Poly-Aluminum(SMD)	16	330	0.014	5050 mA	10×12.5	2	≤2	PXA16VC331MJ12TP
PS, Poly-Aluminum (Radial)	16	330	0.0014	5050 mA	10×12.5	2	≤2	16PS330MJ12
LXZ, Aluminum (Radial)	16	680	0.068	1050 mA	10×16	1	≤1	LXZ16VB681M10 X16LL
Nichicon, Aluminum PM, (Radial)	25	560	0.060	1060 mA	12.5×15	1	1	UPM1E561MHH6
HD, (Radial)	16	680	0.038	1430 mA	10×16	1	2	UHD1C681MHR
	35	560	0.048	1360 mA	16×15	1	1	UPM1V561MHH6
Panasonic, Poly-Alum S/SE(SMD)	6.3	180	0.005	4000 mA	7.3×4.3×4.2	N/R (2)	≤1	EEFSE0J181R
Sanyo TPE, ps-Ccap(SMD)	10	330	0.025	3000 mA	7.3L×5.7W	N/R (2)	≤3	10TPE330M
SEPC Os-con(Radial)	16	470	0.010	>6100 mA	10×13	1 (3)	≤1	16SEPC470M
SVP, Os-con(SMD)	16	330	0.016	4700 mA	11×12	2	≤2	16SVP330M
SVPC, Os-con(SMD)	4	1200	0.010	4700 mA	8×11.9	N/R (2)	≤1	4SVPC1200M
AVX, Tantalum TPS(SMD)	10	470	0.045	>1723 mA	7.3×5.7×4.1	N/R (2)	≤5	TPSE477M019R0045
	10	330	0.045	>1723 mA		N/R (2)	≤5	TPSE337M019R0045
Kemet T520, Poly-Tantalum(SMD)	6.3	470	0.040	1800 mA		N/R (2)	≤5	T520X477M006 ASE040
T530, Tantalum/Organic	4	680	0.010	>5100 mA	4.3×7.3×4	N/R (2)	≤1	T530X687M004 ASE010
T530, Tantalum/Organic	6.3	470	0.010	5200 mA		N/R (2)	≤1	T530X477M006 ASE010
Vishay-Sprague 594D, Tantalum(SMD)	10	470	0.100	1440 mA	7.2×6×4.1	N/R (2)	≤5	594D477X0010R2T
94SVP, Os-con(SMD)	16	330	0.017	>4500 mA	10×12.7	2	≤2	94SVP337X0016F12
94SA, Organic(Radial)	16	1000	0.015	9700 mA	16×25	1	≤2	94SA108X0016HBP
Kemet, Ceramic X5R (SMD)	16	10	0.002	-	3225mm	1 (4)	≤5	C1210C106M4PAC
	6.3	47	0.002		3225mm	N/R (2)	≤5	C1210C476K9PAC
Murata, Ceramic X5R (SMD)	6.3	100	0.002	-	3225mm	N/R (2)	≤3	GRM32ER60J107M
	6.3	47	0.002		3225mm	N/R (2)	≤5	GRM32ER60J476M
	16	22	0.002			1 (4)	≤5	GRM32ER61C226K
	16	10	0.002			1 (4)	≤5	GRM32DR61C106K
TDK, Ceramic X5R (SMD)	6.3	100	0.002	-	3225mm	N/R (2)	≤3	C3225X5R0J107MT
	6.3	47	0.002		3225mm	N/R (2)	≤5	C3225X5R0J476MT
	16	22	0.002			1 (4)	≤5	C3225X5R1C226MT
	16	10	0.002			1 (4)	≤5	C3225X5R1C106MT

**(1) Capacitor Supplier Verification**

Please verify availability of capacitors identified in this table. Capacitor suppliers may recommend alternative part numbers because of limited availability or obsolete products. In some instances, the capacitor product life cycle may be in decline and have short-term consideration for obsolescence.

**RoHS, Lead-free and Material Details**

Please consult capacitor suppliers regarding material composition, RoHS status, lead-free status, and manufacturing process requirements. Component designators or part number deviations can occur when material composition or soldering requirements are updated

(2) A total capacitance of 470 µF is acceptable based on the combined ripple current rating.

(3) N/R –Not recommended. The capacitor voltage rating does not meet the minimum derated operating limits.

(4) A ceramic capacitor may be used to compliment electrolytic types at the input to further reduce high-frequency ripple current

**⚠ Note:**

- This datasheet is downloaded from the website of Murata Manufacturing co., ltd. Therefore, it's specifications are subject to change or our products in it may be discontinued without advance notice. Please check with our sales representatives or product engineers before ordering.
- This datasheet has only typical specifications because there is no space for detailed specifications. Therefore, please approve our product specifications or transact the approval sheet for product specifications before ordering.

## MPDTH12050Y

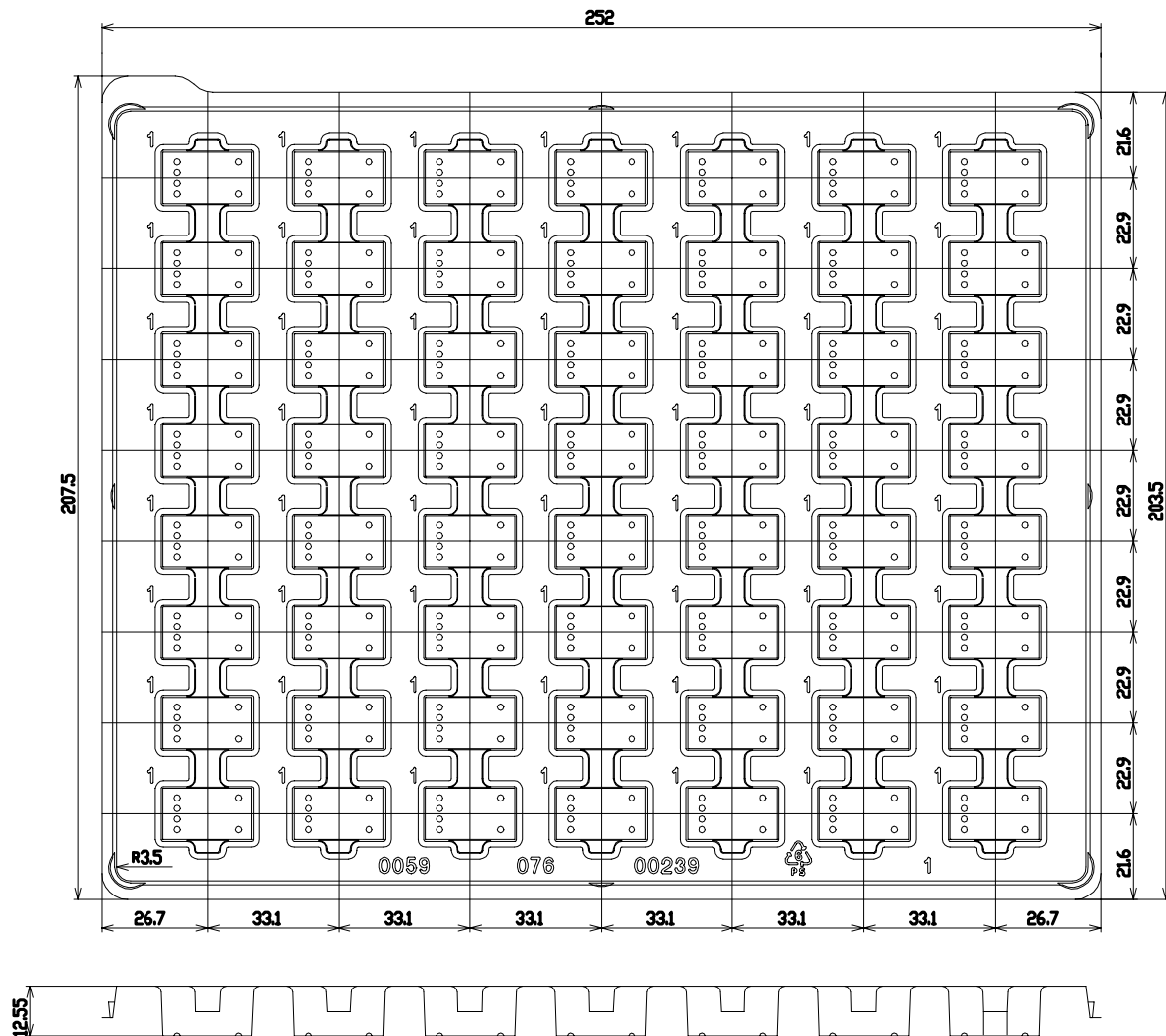

Maximum Pieces per a Tray 56 pcs/(tray)

⚠ **Note:**

1. This datasheet is downloaded from the website of Murata Manufacturing co., ltd. Therefore, it's specifications are subject to change or our products in it may be discontinued without advance notice. Please check with our sales representatives or product engineers before ordering.
2. This datasheet has only typical specifications because there is no space for detailed specifications. Therefore, please approve our product specifications or transact the approval sheet for product specifications before ordering.

## MPDTH12050Y

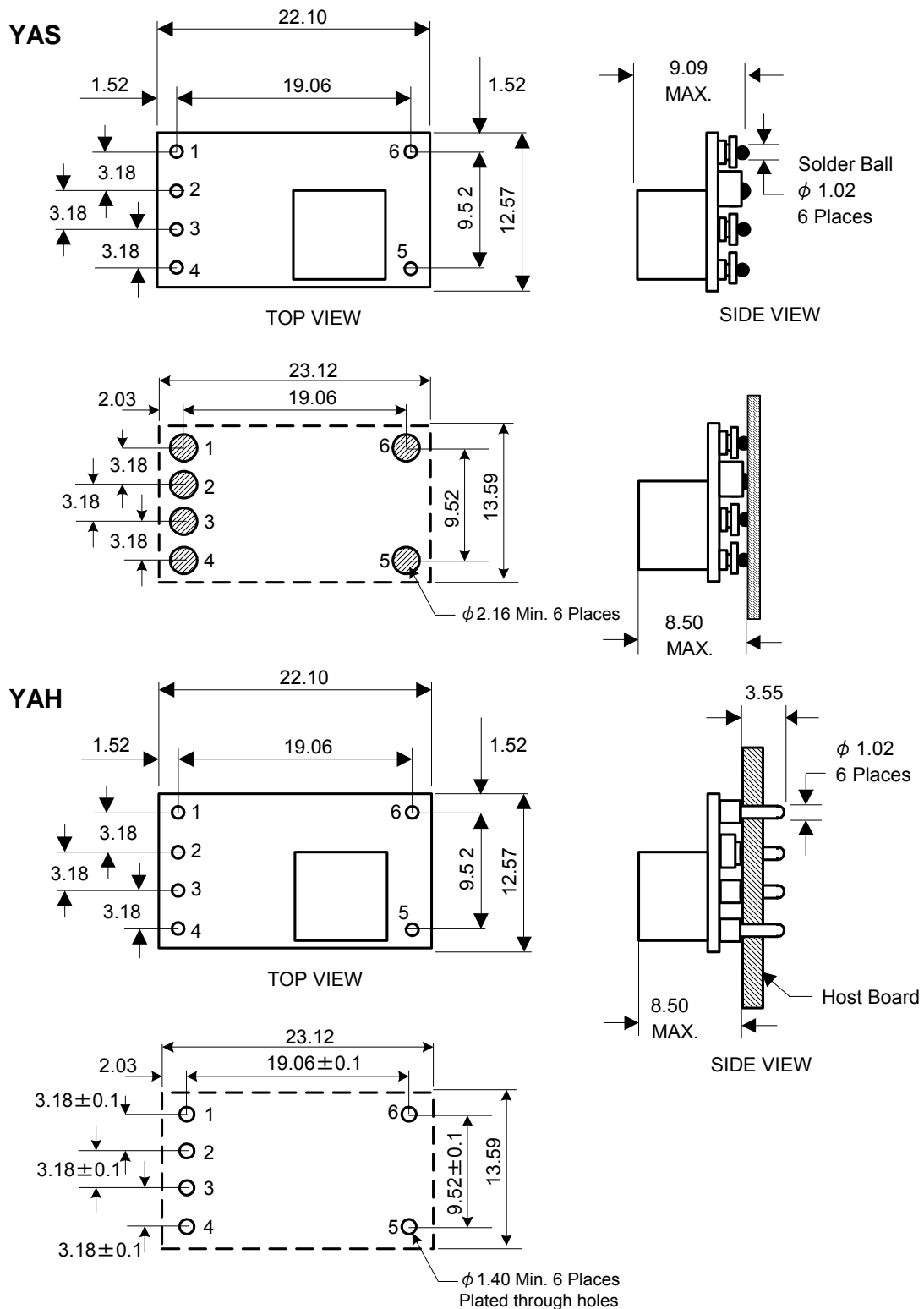

⚠ **Note:**

1. This datasheet is downloaded from the website of Murata Manufacturing co., ltd. Therefore, it's specifications are subject to change or our products in it may be discontinued without advance notice. Please check with our sales representatives or product engineers before ordering.
2. This datasheet has only typical specifications because there is no space for detailed specifications. Therefore, please approve our product specifications or transact the approval sheet for product specifications before ordering.

### IMPORTANT NOTICE

Murata Manufacturing Co., Ltd. and its subsidiaries (Murata) reserve the right to make corrections, modifications, enhancements, improvements, and other changes to its products and services at any time and to discontinue any product or service without notice. Customers should obtain the latest relevant information before placing orders and should verify that such information is current and complete. All products are sold subject to Murata's terms and conditions of sale supplied at the time of order acknowledgment.

Murata warrants performance of its hardware products to the specifications applicable at the time of sale in accordance with Murata's standard warranty. Testing and other quality control techniques are used to the extent Murata deems necessary to support this warranty. Except where mandated by government requirements, testing of all parameters of each product is not necessarily performed.

Murata assumes no liability for applications assistance or customer product design. Customers are responsible for their products and applications using Murata components. To minimize the risks associated with customer products and applications, customers should provide adequate design and operating safeguards.

Murata does not warrant or represent that any license, either express or implied, is granted under any Murata patent right, copyright, or other Murata intellectual property right relating to any combination, machine, or process in which Murata products or services are used. Information published by Murata regarding third-party products or services does not constitute a license from Murata to use such products or services or a warranty or endorsement thereof. Use of such information may require a license from a third party under the patents or other intellectual property of the third party, or a license from Murata under the patents or other intellectual property of Murata.

Reproduction of information in Murata data books or data sheets is permissible only if reproduction is without alteration and is accompanied by all associated warranties, conditions, limitations, and notices. Reproduction of this information with alteration is an unfair and deceptive business practice. Murata is not responsible or liable for such altered documentation.

Resale of Murata products or services with statements different from or beyond the parameters stated by Murata for that product or service voids all express and any implied warranties for the associated Murata product or service and is an unfair and deceptive business practice. MURATA is not responsible or liable for any such statements.

Copyright 2006, Murata Manufacturing Co., Ltd.

**⚠ Note:**

1. This datasheet is downloaded from the website of Murata Manufacturing co., ltd. Therefore, it's specifications are subject to change or our products in it may be discontinued without advance notice. Please check with our sales representatives or product engineers before ordering.
2. This datasheet has only typical specifications because there is no space for detailed specifications. Therefore, please approve our product specifications or transact the approval sheet for product specifications before ordering.