

**OBSOLETE PRODUCT**

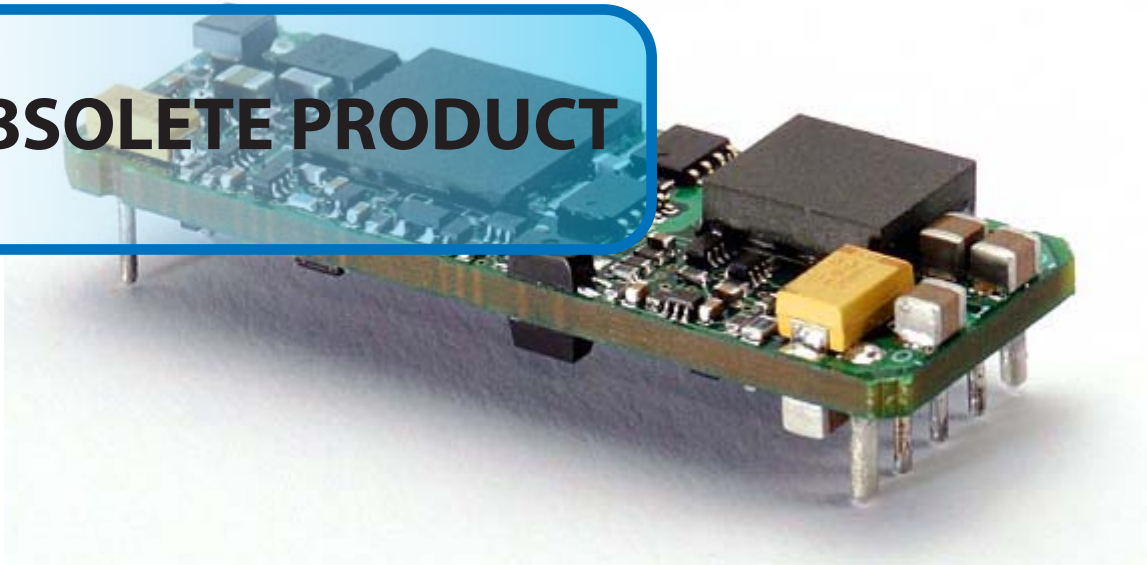

Model		5V	Units
<b>Parameter</b>			
Output Voltage Setpoint		4.95 – 5.05	Vdc
Line/Load Regulation	Max	0.1%, 0.2%	% Vo
Output total regulation		4.85 – 5.15	Vdc
Output adjust (note 4)		90-110	%Vo,nom
Remote-sense Comp.		10%	V
Output Ripple & Noise (note 2)	Max	100	mVp-p
Output Current		0-10	A
Efficiency (48V, Full load, 25C)	Typ	90%	%
External Capacitance		1,000-10,000	μF
Transient Response (typ) (note 3)	ΔVo	165	mV
25% step, 1A/μs	Ts	400	μs
Over-voltage trip point	(latch ing)	5.8 – 6.4	V
Over-current trip point (non-latching)	Typ	13	A

All specifications, waveforms, charts at Ta=25C, Vin=48V, unless otherwise specified



Parameter	Conditions	Min.	Typ.	Max.	Units
Input	Input Voltage (Vin)	36	48	75	Vdc
	Reflected Ripple Current	See note (1)	10	--	mA p-p
	Inrush Transient			0.2	A <sup>2</sup> s
	Input Voltage Transient	100mS 10% duty cycle			100
Undervoltage Lockout	Turn-on	32		35	Vdc
	(non-latching) Turn-off	31		34	Vdc
	Over-voltage lockout (non-latching) Turn-off	77		81	Vdc
Isolation	Input-Output	1500			Vdc
	Resistance; input-output	10			Mohm
Temperature	Operating Ambient	-40	--	90	°C
	Storage	-40	--	125	°C
Protection	Over-Temperature (non-latching) (Measured on PCB at TML)		130		°C
Physical Information	Dimensions	2.30"L x 0.82" W x 0.37"H (58.4 x 20.8 x 9.3 mm)			
MTBF	Calculated at 40C ambient, (Bellcore)	1,000,000 Hrs		EHS15/20 Series	
	Demonstrated at 40C ambient with 90% confidence:	2,800,000 Hrs			
Safety	Complies with IEC/EN/CSA/UL 60950, provides basic insulation, input to output. c-UL-us (US and Canada) recognized, TUV certified (Bauart).				

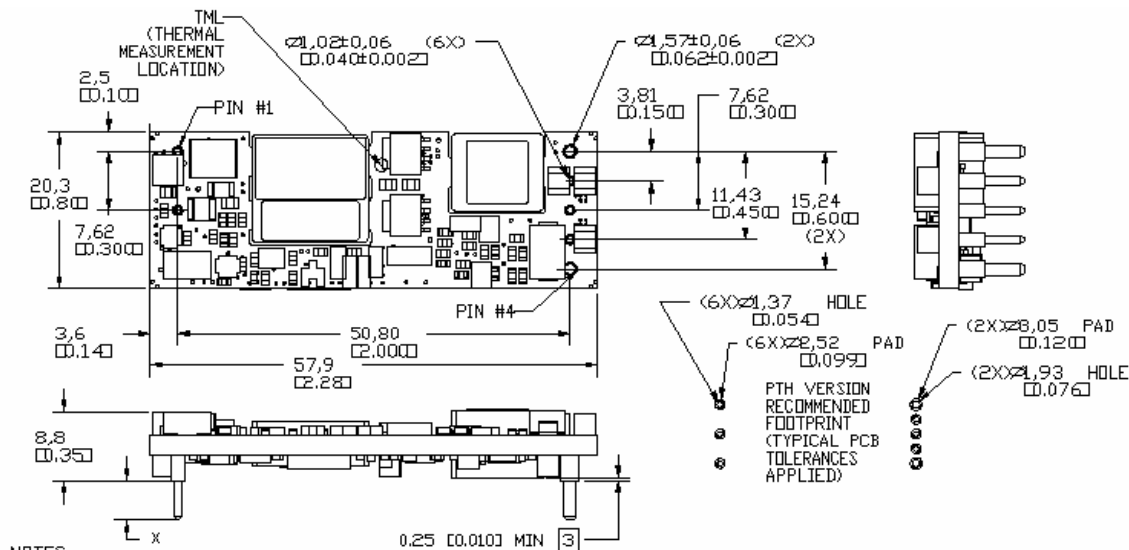

NOTES:  
 1. MM [INCH]  
 2. BASIC TOLERANCES: X.X [X.XXX] ±0.5 [0.02]  
 X.XX [X.XXX] ±0.25 [0.010]  
 3. STANDOFF TO ASSURE A MIN. OF 0.25 [0.010] BETWEEN LOWEST COMPONENT AND MOUNTING PLANE

### Pin Assignments

Pin #	Description	Pin #	Description	Pin #	Description
1	Vin (+)	4	Vout(-)	7	Sense +
2	Enable	5	Sense -	8	Vo (+)
3	Vin(-)	6	Vo adj		

**EHS10-050 Thermal Derating**  
Airflow from Input to Output, Tj=120C

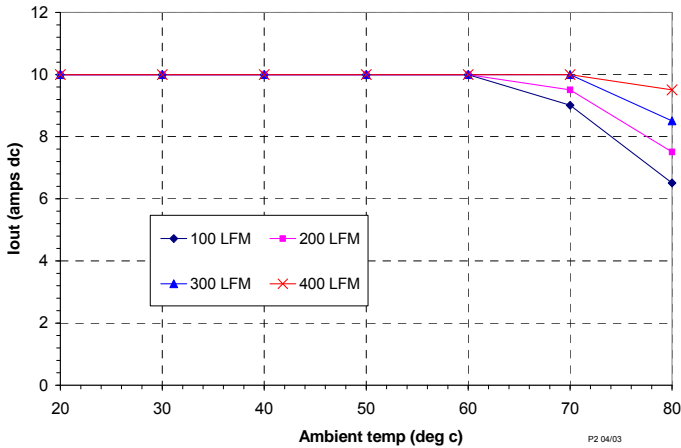

**EHS10-050 Thermal Derating**  
Airflow from Vin(-) to Vin(+), Tj=120C

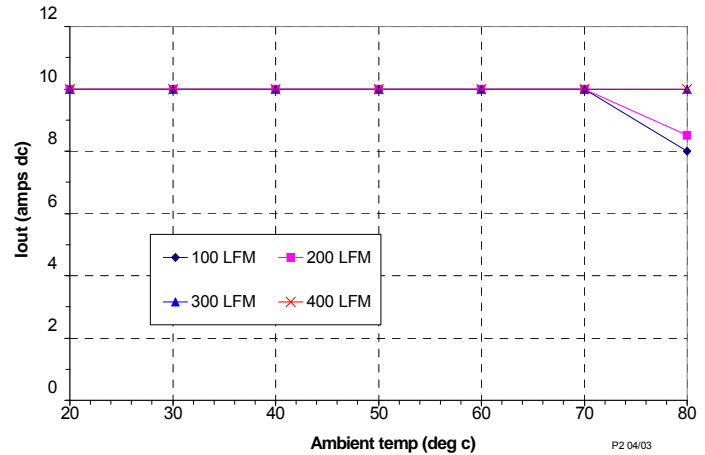

**EHS10-050**  
Efficiency vs. Output Current, 25°C

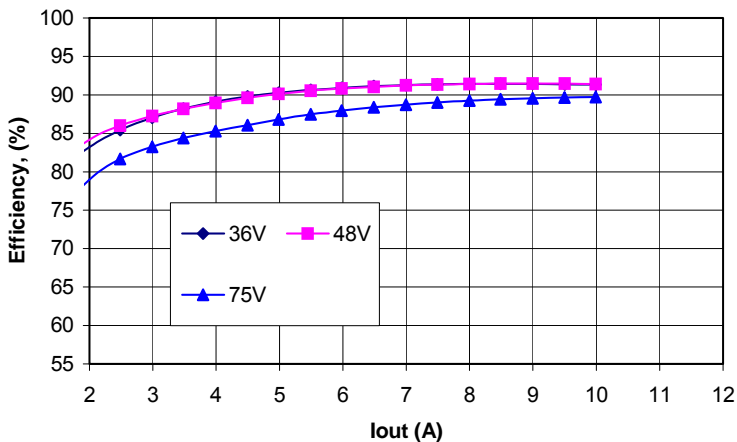

**EHS10-050 Enable with Pre-Bias**

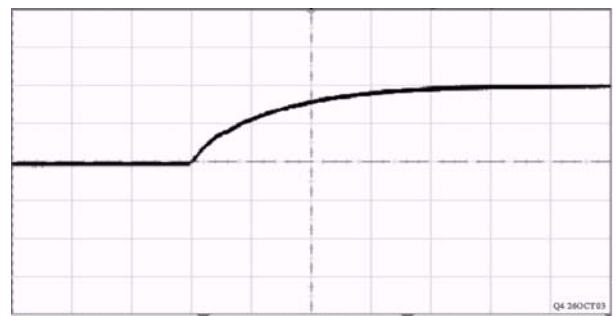

Output Voltage @ 1.0 V/div., 2 ms/div.  
Prebias voltage = 3.0 VDC. Input Voltage 48 V  
Load = 0 A, Load capacitance = 2200 uF.

**EHS10-050 Trim-up and Trim-down Resistance**

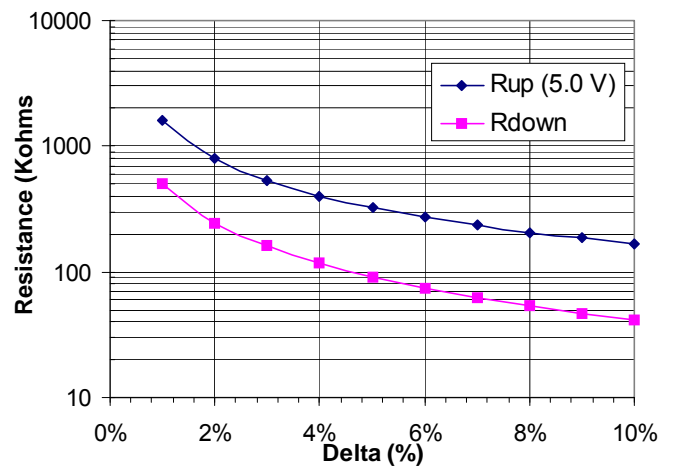

**Trim Up/Down Formula : 5V model**

$$R_{up} := \left[ \frac{5.10 V_{nom} (100 + \%)}{1.225 \%} - \frac{510}{\%} - 10.2 \right] K$$

Where  $\% := \frac{(V_{out} - V_{nom}) 100}{V_{nom}}$  and, Vout = Target output voltage

$$R_{down} (\%) := \left( \frac{510}{\%} - 10.2 \right) K \quad \text{Where } \% := \frac{(V_{nom} - V_{out}) 100}{V_{nom}}$$

**EHS10-050 Startup Sequence from Enable**

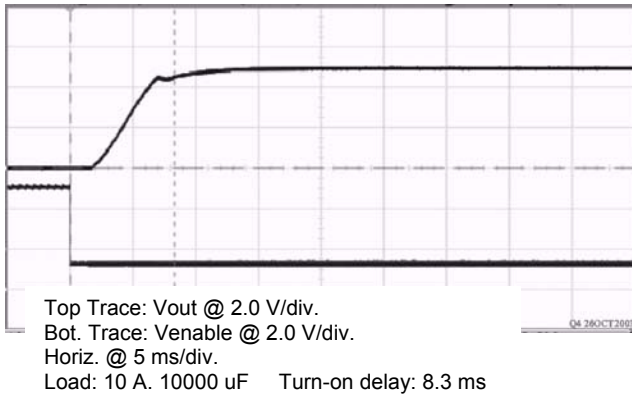

**EHS10-050 Startup Sequence from Vin**

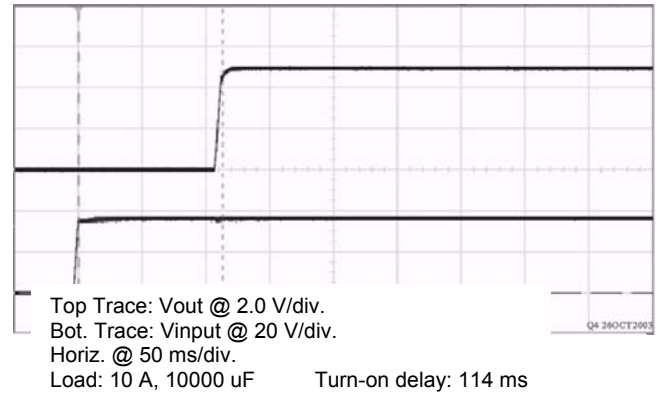

**EHS10-050 Transient Response, Step up 1A/μs**

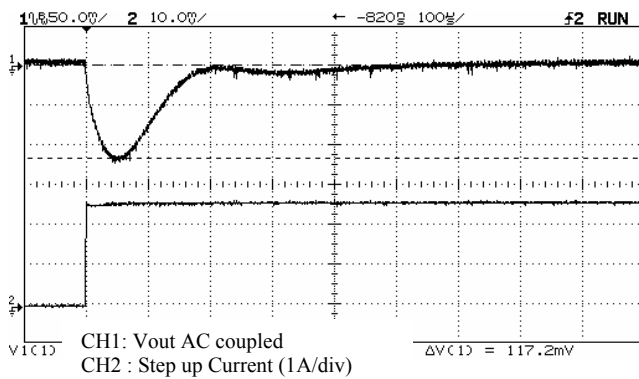

**EHS10-050 Transient Response, Step down 1A/μs**

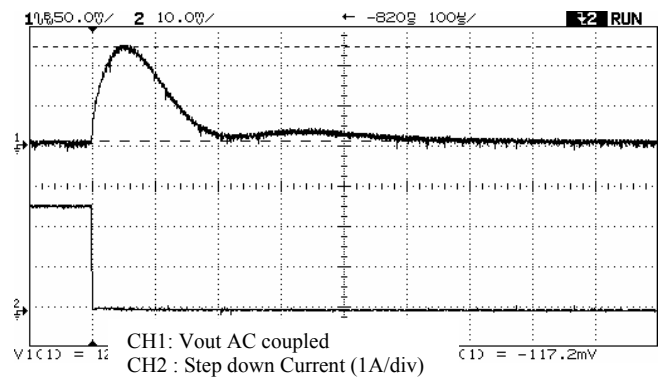

**EHS10-050 Input Reflected Ripple Current**

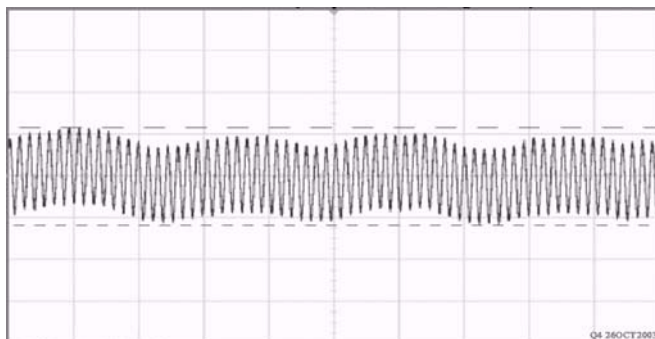

Input Current @ 5 mA/div., 20 us/div. (11.7 mApp)  
 Input Voltage: 48 V, Load Current: 10 A  
 Note: see test circuit on following page.

**EHS10-050 Output Ripple Voltage, Io=10A**

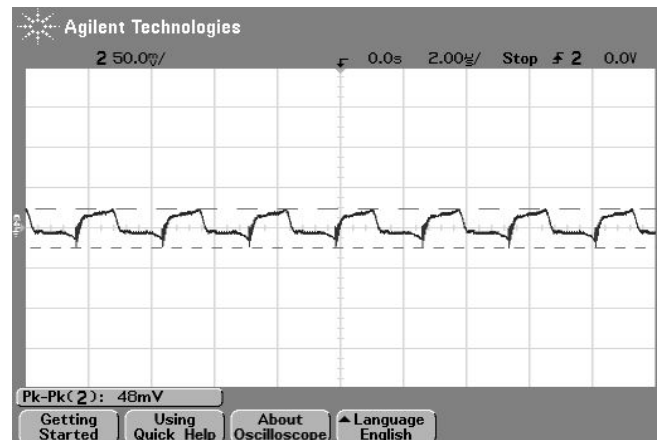

**Notes:**

1. Input Reflected Ripple is specified when measured with the filter shown below

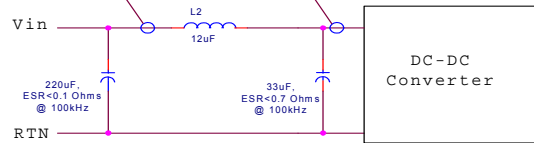

2. Output Ripple and noise is specified when measured with a 10uF tantalum and a 1uF ceramic capacitor at the converter output pins
3. Transient response is specified with a 470uF tantalum capacitor at the output of the converter
4. Trim resistor connection: Rtrim-up connected from Vo adj to Vo(+), Rtrim –down connected from Vo adj to Vo(-).

**EHS10 Enable Pin Connection Table**

	ENABLE POWER SUPPLY	DISABLE POWER SUPPLY
NEGATIVE LOGIC VERSION	0V < Venable < 0.8V (internal pull-up > 50Kohms @ 5V)	2.5V < Venable < 15V (external pull-up > 1Kohms)
POSITIVE LOGIC VERSION	2.5V < Venable < 15V (external pull-up > 1Kohms)	0V < Venable < 0.8V (internal pull-up > 50Kohms @ 5V)

Note: Power Supply has internal pull-up resistor. Enable pin is in a valid “high” state if left open-circuit.

**Safety considerations**

The EHS series of converters are certified to IEC/EN/CSA/UL 60950. If this product is built into information technology equipment, the installation must comply with the above standard.

An external input fuse (5A to 30A recommended), must be used to meet the above requirements.

The output of the converter [Vo(+)/Vo(-)] is considered to remain within SELV limits when the input to the converter meets SELV or TNV-2 requirements.

The converters and materials meet UL 94V-0 flammability ratings.

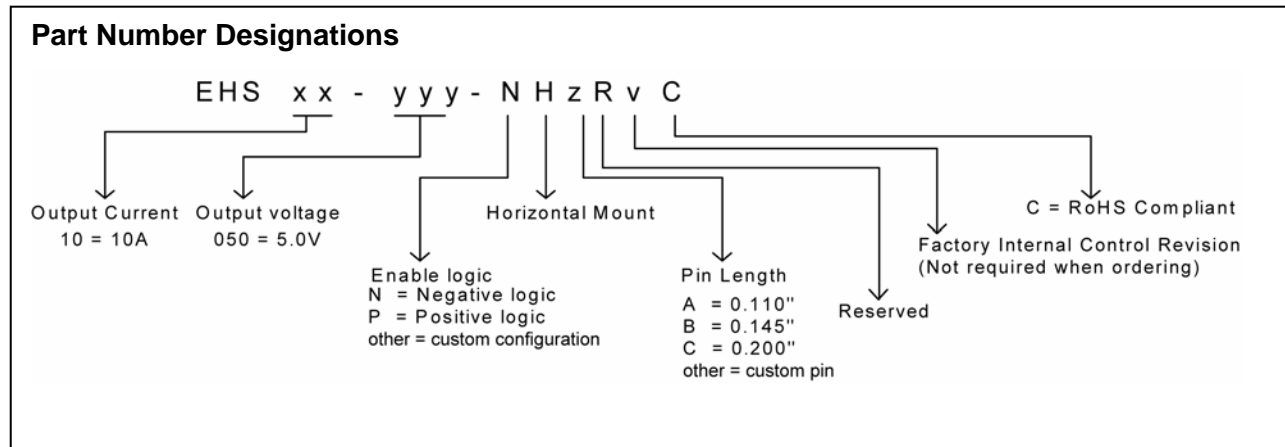

Murata Power Solutions, Inc.  
11 Cabot Boulevard, Mansfield, MA 02048-1151 U.S.A.  
ISO 9001 and 14001 REGISTERED



**This product is subject to the following [operating requirements](http://www.murata-ps.com/requirements/) and the [Life and Safety Critical Application Sales Policy](http://www.murata-ps.com/requirements/):**  
Refer to: <http://www.murata-ps.com/requirements/>

Murata Power Solutions, Inc. makes no representation that the use of its products in the circuits described herein, or the use of other technical information contained herein, will not infringe upon existing or future patent rights. The descriptions contained herein do not imply the granting of licenses to make, use, or sell equipment constructed in accordance therewith. Specifications are subject to change without notice. © 2012 Murata Power Solutions, Inc.