

**OBSOLETE PRODUCT**

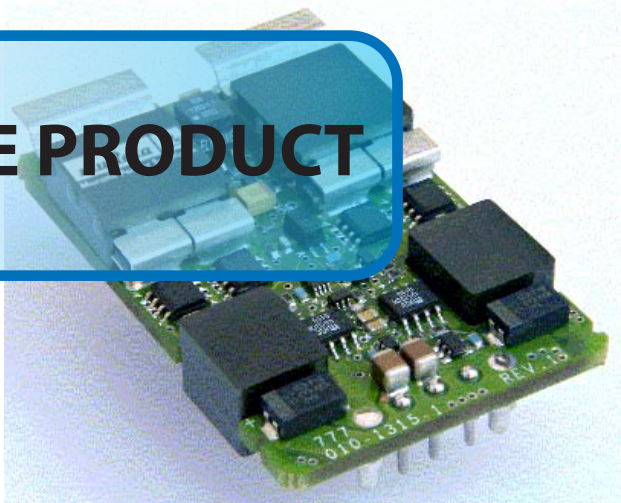

Model	2.5V		Units
Parameter			
Output Voltage Setpoint		2.475 – 2.525	Vdc
Line/Load Regulation	Max	0.1%, 0.2%	% Vo
Output total regulation		2.43 – 2.57	Vdc
Output adjust		90-110	%Vo,nom
Remote-sense Comp.		10%	V
Output Ripple & Noise (note 2)	Max	100	mVp-p
Output Current	Min	0.5	A
	Max	40	A
Efficiency (48V, Full load, 25C)	Typ	88.5%	%
External Capacitance	Max	10,000	μF
Transient Response (typ) (note3)	ΔVo	150	mV
	Ts	300	μs
Over-voltage trip point	-static	3.0 – 3.3	V
	-dynamic max	3.5	
Over-current trip point	Typ	46	A

All specifications at Ta=25C, Vin=48V, 300 LFM unless otherwise specified



## QHS40-025 Model

Parameter	Conditions	Min.	Typ.	Max.	Units	
Input	Input Voltage (Vin)	36	48	75	Vdc	
	Reflected Ripple Current (see note 1)	--	--	10	mA p-p	
	Input Current			3.3	A	
	Inrush Transient			0.2	A <sup>2</sup> s	
	Input Voltage Transient	100mS 10% duty cycle			100	V
Undervoltage Lockout	Turn-on	31		35	Vdc	
		31		34	Vdc	
	Turn-off	76		80	Vdc	
		75		79	Vdc	
Isolation	Input-Output	1500			Vdc	
	Resistance; input-output	10			Mohm	
Temperature	Operating Ambient	-40	--	85	°C	
	Storage	-40	--	125	°C	
Protection	Over-Temperature	Measured on PCB	--	110	--	Deg C
Physical Information	Dimensions	2.28"L x 1.45" W x 0.47"H (57.91 x 36.83 x 11.8 mm)				
MTBF(Bellcore)	Calculated at 40C ambient, 100% Iomax:	1,000,000 Hrs				
Safety	Complies with IEC/EN/CSA/UL 60950, provides basic insulation, input to output. c-UL-us (US and Canada) recognized. TUV (Bauart) approved.					

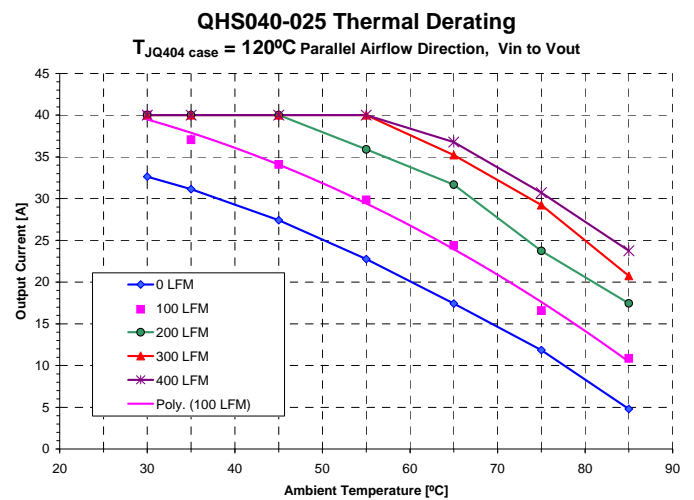
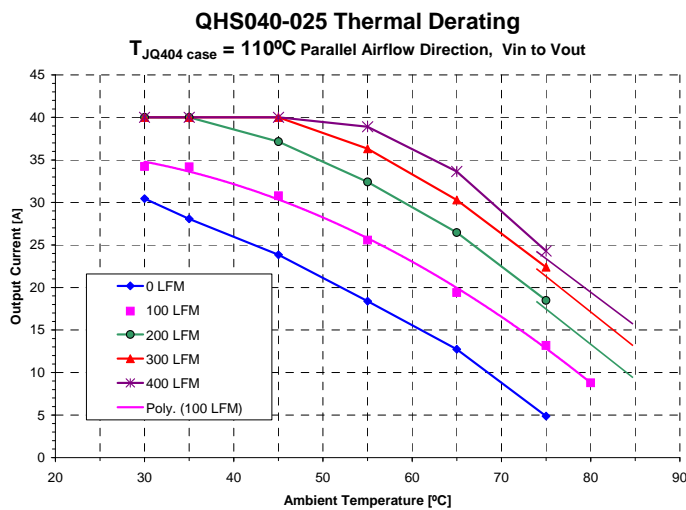

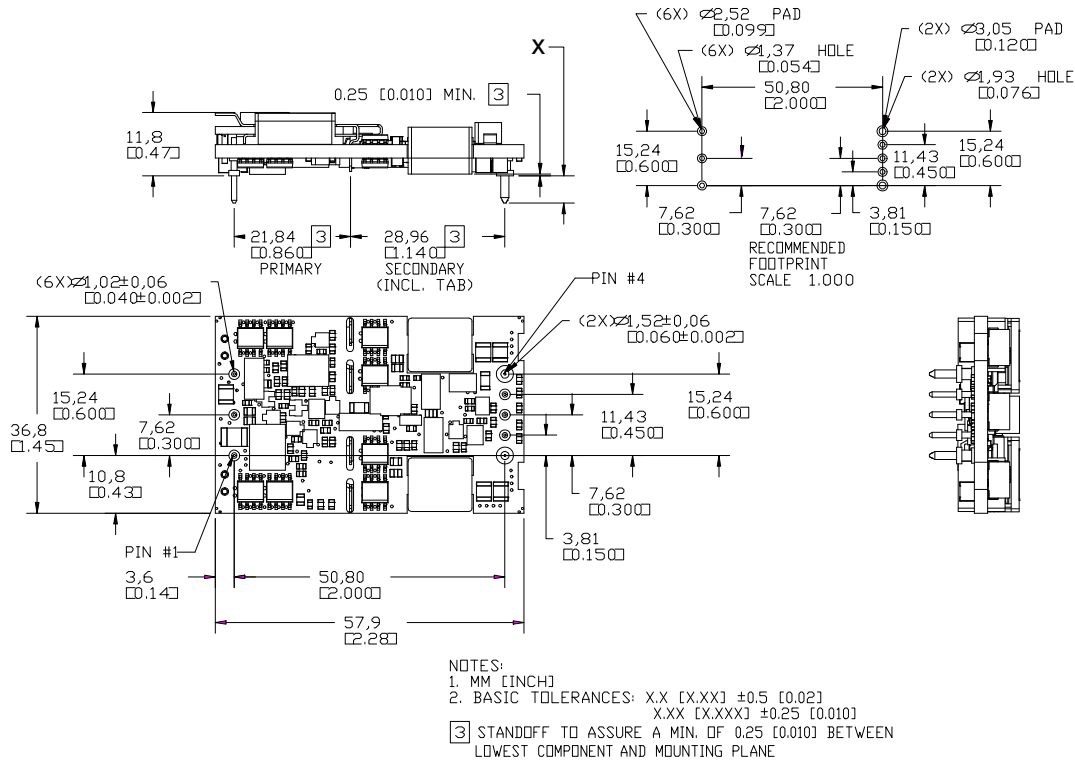

**Pin Assignments**

Pin #	Description	Pin #	Description	Pin #	Description
1	Vin (+)	4	Vout(-)	7	Sense +
2	Enable	5	Sense -	8	Vo (+)
3	Vin(-)	6	Vo adj		

**Notes:**

1. Input Reflected Ripple is specified when measured with the filter shown below.

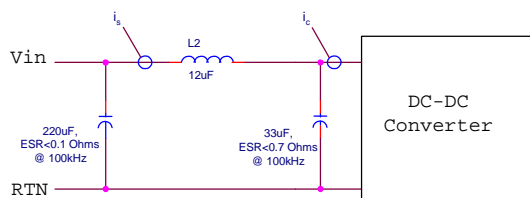

2. Output Ripple and noise is specified when measured with a 10uF tantalum and a 1uF ceramic capacitor at the converter output pins.
3. Transient response is specified without a capacitor at the output of the converter.
4. The Enable signal is Logic Low. It is referenced to Vi-. The pin should be tied to Vi- if it is not used. Isink = 1mA max, Voff = 15V max.

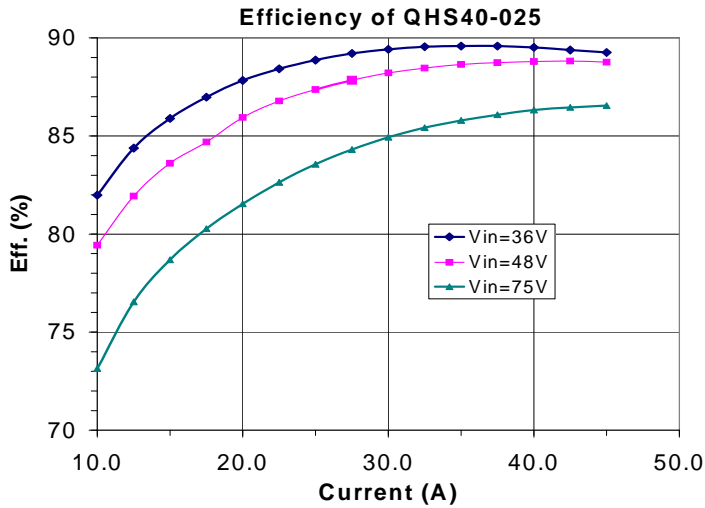

Output Ripple and Noise  
(Vin=48V, Io=40A, 100Mz BW)

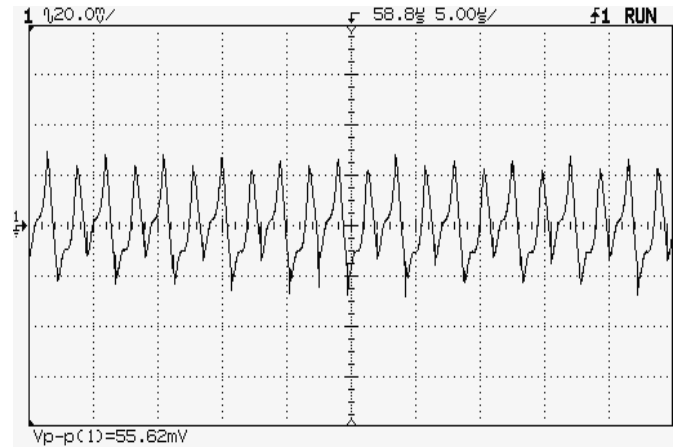

Output Voltage Response to Step Load (30A → 20A load step, di/dt = 1A/us, Tamb=25C, Vin=48V)

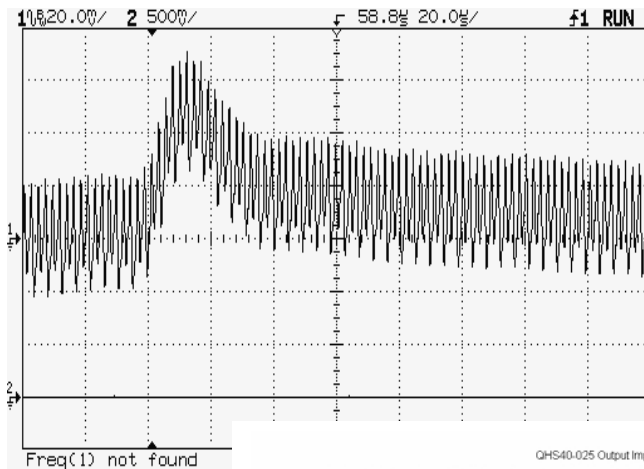

Output Voltage Response to Step Load (20A → 30A load step, di/dt = 1A/us, Tamb=25C, Vin=48V)

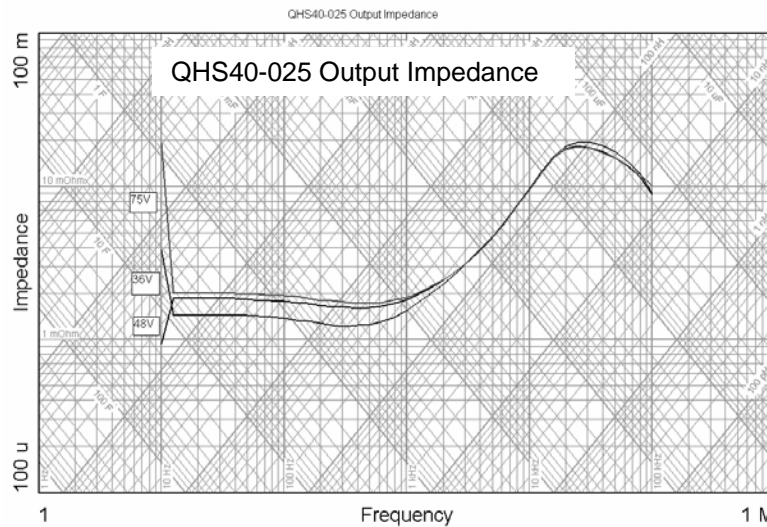
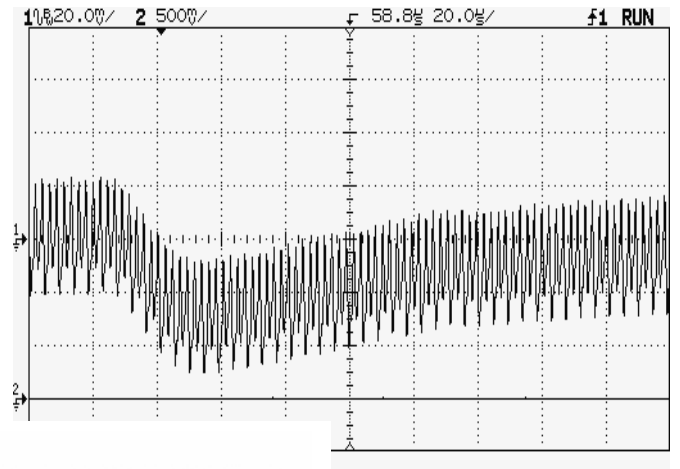

### Input Reflected Ripple (Vin=48V, Iout=50A)

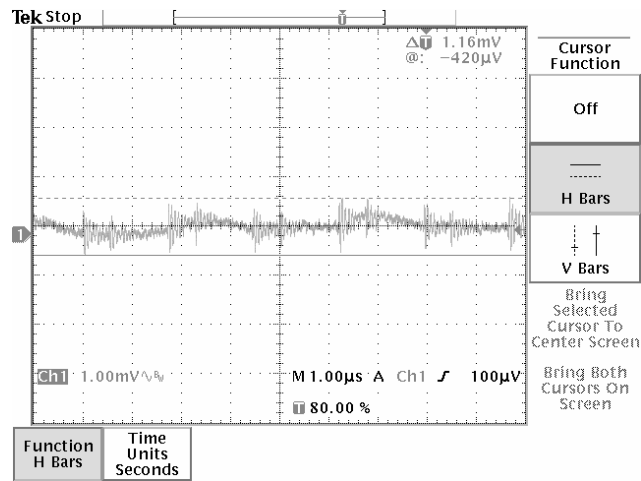

### Startup Characteristics

Vin = 48V Iout = 0A Local O/P Sensing

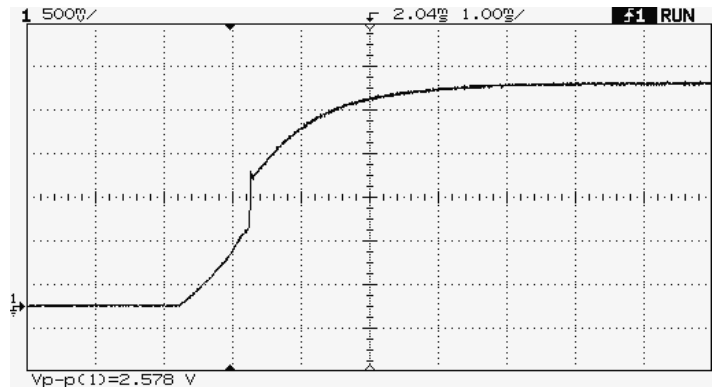
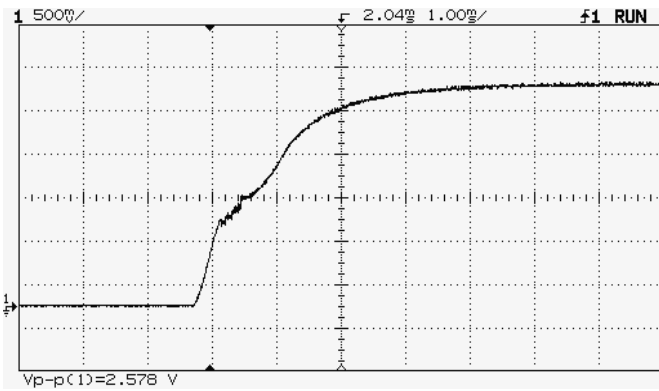

### Conducted EMI Characteristic with external filter as specified

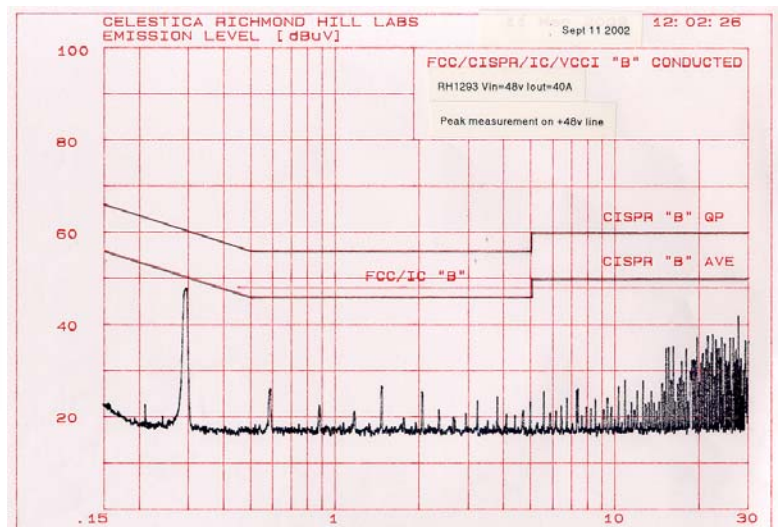
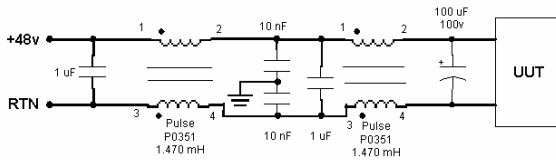

$$R_{up}(V_{nom}, \Delta\%) := \left[ 5.11 \cdot V_{nom} \cdot \frac{(100 + \Delta\%)}{1.225 \cdot \Delta\%} \right] - \left( \frac{511}{\Delta\%} \right) - 10.22$$

$$R_{dwn}(\Delta\%) := \frac{511}{\Delta\%} - 10.22$$

$$\Delta\% = \left\lceil 100 \times (V_o - V_{nom}) / V_{nom} \right\rceil$$

$V_o$ : target output voltage

$V_{nom}$ : nominal output voltage

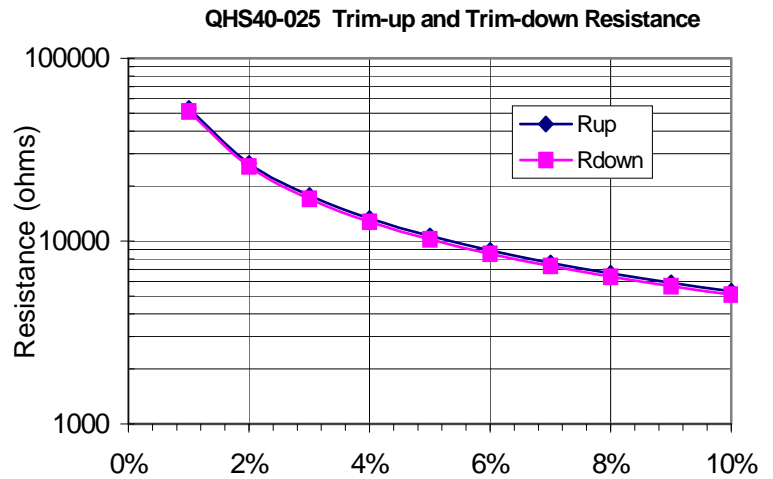

### Safety considerations

The QHS series of converters are certified to IEC/EN/CSA/UL 60950. If this product is built into information technology equipment, the installation must comply with the above standard.

An external input fuse (5A to 30A recommended), must be used to meet the above requirements.

The output of the converter [ $V_o(+)/V_o(-)$ ] is considered to remain within SELV limits when the input to the converter meets SELV or TNV-2 requirements.

The converters and materials meet UL 94V-0 flammability ratings.

### Part Number Designations

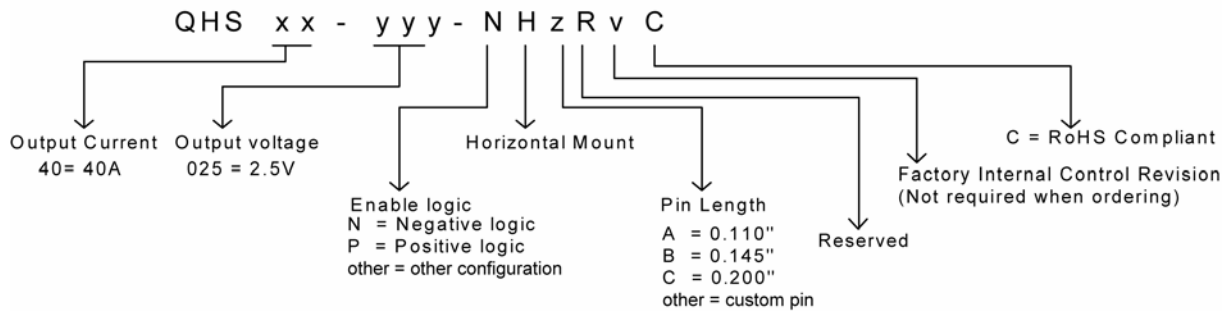

Murata Power Solutions, Inc.  
11 Cabot Boulevard, Mansfield, MA 02048-1151 U.S.A.  
ISO 9001 and 14001 REGISTERED



**This product is subject to the following [operating requirements](#) and the [Life and Safety Critical Application Sales Policy](#):  
Refer to: <http://www.murata-ps.com/requirements/>**

Murata Power Solutions, Inc. makes no representation that the use of its products in the circuits described herein, or the use of other technical information contained herein, will not infringe upon existing or future patent rights. The descriptions contained herein do not imply the granting of licenses to make, use, or sell equipment constructed in accordance therewith. Specifications are subject to change without notice.  
© 2012 Murata Power Solutions, Inc.