

OBSOLETE

NNL10 Series

Non-Isolated DC/DC Converters



FEATURES

- RoHS compliant
- Industry standard footprint
- Short circuit protection
- High efficiency
- Under voltage lock out
- Output voltage trimming
- Operating temperature range -40°C to 85°C
- SMD Construction
- Optional DC OK signal
- Options available without Trim and Remote Sense Functionality

DESCRIPTION

The NNL10 series is part of a range of non-isolated, cost effective DC/DC converters offering high precision output voltages from a nominal 3.0-5.5V or 10.0-14.0V intermediate bus where isolation is not required. The series has been recognized by Underwriters Laboratory (UL) to UL 60950, file number E179522 applies.

SELECTION GUIDE¹

Recommended Alternative	Order Code ²	Nominal Input Voltage	Output Voltage	Output Current		Max. Output Power	Nominal Efficiency	
		V	V	Min.Load A	Full Load A	W	% (Min.)	
Recommended alternative: OKY-T/10-W5P-C >> click here to download the data sheet	NNL10-1C	4.0	0.9	0	10	9	79.7	
	NNL10-2C	4.0	1.0	0	10	10	81.8	
	NNL10-3C	4.0	1.2	0	10	12	84.3	
	NNL10-4C	4.0	1.5	0	10	15	86.5	
	NNL10-5C	4.0	1.8	0	10	18	88.2	
	NNL10-6C	4.0	2.0	0	10	20	89.2	
	NNL10-7C	4.0	2.5	0	10	25	91.2	
	NNL10-8C	4.0	3.3	0	10	33	92.1	
Recommended alternative: OKY2-T/10-W5P-C >> click here to download the data sheet	With DCOK	NNL10-9C	4.0	0.9	0	10	9	79.7
		NNL10-10C	4.0	1.0	0	10	10	81.8
		NNL10-11C	4.0	1.2	0	10	12	84.3
		NNL10-12C	4.0	1.5	0	10	15	86.5
		NNL10-13C	4.0	1.8	0	10	18	88.2
		NNL10-14C	4.0	2.0	0	10	20	89.2
		NNL10-15C	4.0	2.5	0	10	25	91.2
		NNL10-16C	4.0	3.3	0	10	33	92.1

INPUT CHARACTERISTICS

Parameter	Conditions	Min.	Typ.	Max.	Units
Voltage range	V _{NOM} = 4.0V _{DC} V _{OUT} < 2.75V	3.0		5.5	V
	V _{NOM} = 4.0V _{DC} V _{OUT} > 3.0V	4.0		5.5	
Under voltage lock out	Turn on threshold V _{NOM} = 4.0V _{DC}		2.8		V
	Turn off threshold V _{NOM} = 4.0V _{DC}		2.7		
Reflected ripple current			30		mA p-p
Input no load current	V _{IN} = 5.5V V _{OUT} = 0.9V		100		mA
	V _{IN} = 5.5V V _{OUT} = 3.3V		140		
Input standby current	V _{IN} = 5.5V Module disabled		1.5		mA

OUTPUT CHARACTERISTICS

Parameter	Conditions	Min.	Typ.	Max.	Units
Rated current	T _A = -40°C to 85°C (see thermal performance characteristics)			10.0	A
Voltage set point accuracy			1.0	2.0	%
Line regulation	Low line to high line		0.5	1.0	%
Load regulation	0% load to 100% load			0.55	%
Ripple & noise	BW = DC to 20MHz		25	50	mVp-p
Voltage trim		-10		+10	%V _{OUT}
Remote sense				0.5	V
Transient response	I _{OUT} = 5.0A-10.0A-5.0A	Peak deviation		100	mV
	C _{OUT} = 1µF/10µF	Settling time		70	µs
External load capacitance			10,000		µF

1. A 330µF low ESR capacitor, approx 17mΩ at 100kHz to 300kHz must be fitted at the input to the NNL DC/DC converter to ensure stability under all the operating conditions.
 2. If components are required in tape and reel format suffix order code with -R, e.g. NNL10-10C-R.
- All specifications typical at T_A = 25°C, nominal input voltage and rated output current unless otherwise specified.



For full details go to
www.murata-ps.com/rohs

ABSOLUTE MAXIMUM RATINGS

Short circuit protection	Continuous
Remote sense	$V_{OUT} \pm 0.5V_{DC}$
DC OK	-0.2V _{DC} to +17V _{DC} 20mA
Input voltage V _{IN}	6.5V _{DC}
Trim	-0.3V to V _{OUT}
Remote ON/OFF	-0.2V _{DC} to +17V _{DC}
Minimum load	0%



GENERAL CHARACTERISTICS¹

Parameter		Min.	Typ.	Max.	Units
Switching frequency			300		kHz
Start delay	From power on/remote off		4.0		ms
Remote on/off	Module on (or pin unconnected)	2.6			V
	Module off			100	μA
MTTF				0.3	V
				-500	μA
		TBA			kHrs

TEMPERATURE CHARACTERISTICS¹

Parameter	Conditions	Min.	Typ.	Max.	Units
Operation	See thermal performance characteristics	-40		85	°C
Storage		-55		125	°C
Over temperature protection	Substrate temperature		115		°C

APPLICATION NOTES

Output Voltage Trimming

The trimming input on the NNL10 allows output voltage adjustment by ±10% of nominal output voltage by connection of a resistor or by application of a voltage to the Trim pin.

To increase the output voltage, an external resistor (Fig.1) or voltage source should be connected between the Trim and the common pin.

$$R_{TRIM-UP} = \frac{24.080}{|\Delta V_{OUT}|} - R_{INTERNAL} \text{ K}\Omega$$

$$V_{TRIM-UP} = 0.8 - \left[\frac{\Delta V_{OUT} \times R_{INTERNAL}}{30.100} \right]$$

ΔV_{OUT} is the required change in output voltage in V.

To decrease the output voltage, an external resistor (Fig. 2) or voltage source should be connected between the Trim pin and the +V_{OUT} pin.

$$R_{TRIM-DOWN} = \left[\left(\frac{\Delta V_{OUT} - 0.8}{|\Delta V_{OUT}|} - 1 \right) \times 30.100 \right] - R_{INTERNAL} \text{ K}\Omega$$

$$V_{TRIM-DOWN} = 0.8 + \left[\frac{|\Delta V_{OUT}| \times R_{INTERNAL}}{30.100} \right]$$

The trim pin should be left disconnected if not used.

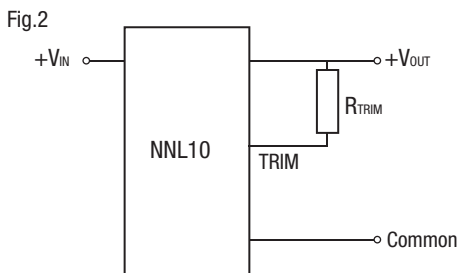
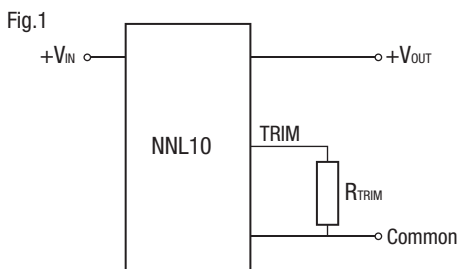

R _{INTERNAL} VALUES	
V _{OUT} SET (V)	R _{INTERNAL} (kOhm)
0.9	5.1
1.0	30.1
1.2	59
1.5	100
1.8	100
2.0	100
2.5	78.7
3.3	59

1. Specifications typical at T_A =25°C, nominal input voltage and rated output current unless otherwise specified.

APPLICATION NOTES (continued)

Remote Sense

The remote sense function compensates for voltage drops from the output of the NNL10 to the load point by regulating the output voltage at the load point. The voltage drop must not exceed 0.5V, although Trim and remote sense functions can be used in combination with each other, the maximum voltage increase is 0.5V.

When increasing the output voltage the maximum output power of the NNL10 must not exceed the maximum output figures stated in the selection guide.

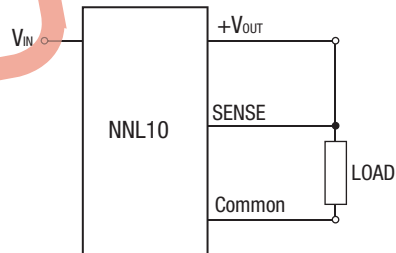

Output Sequencing

To simplify output sequencing, the NNL10 series offers an optional single wire interconnection that performs this function. Using this connection, up to four devices can be 'daisy chained' together, with the 'DC OK' signal from one converter signifying that the next converter can be enabled. A capacitor, simply connected to the daisy chain link, provides a settable delay in the sequence of the converters starting.

Typical capacitor values and corresponding delays are shown in the table below.

Figure 3 shows a typical sequencing configuration, along with the voltage outputs that it produces. As well as reducing component count, making use of the 'built-in' sequencing capability means that only a single PCB track is required for a full sequencing solution.

V _{IN}	Capacitor	Delay
3.0V _{Dc}	0.22µF	1.8ms
5.5V _{Dc}	0.22µF	0.6ms

Fig.3

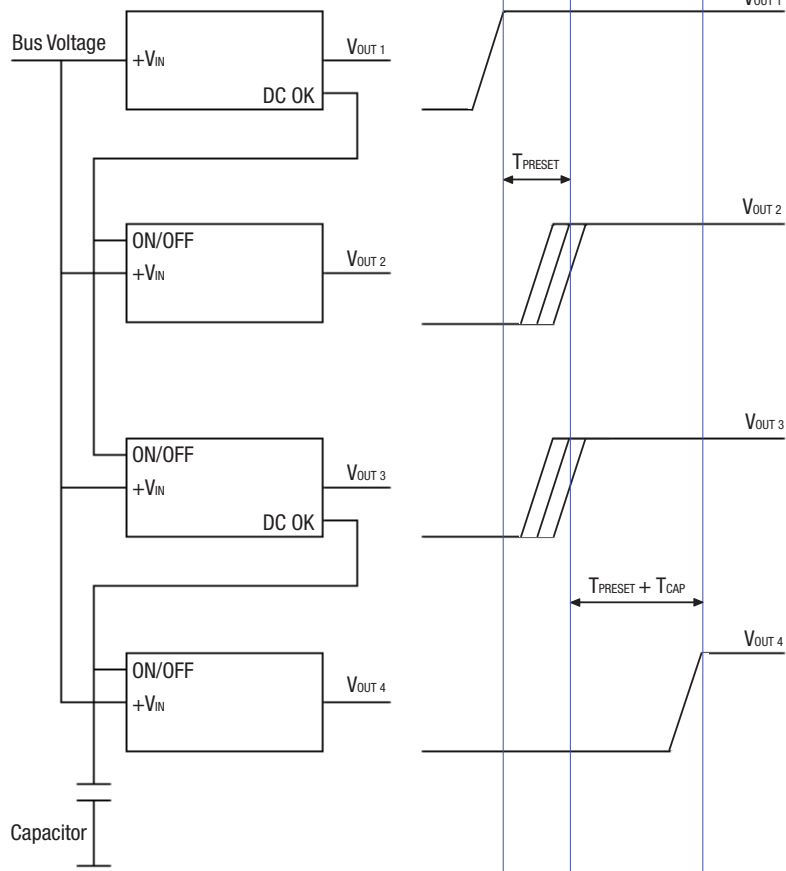

RoHS COMPLIANCE INFORMATION



This series is compatible with RoHS soldering systems with a peak reflow solder temperature of 245°C. The pin termination finish on this product series is Matte Tin over Nickel Preplate. The series is backward compatible with Sn/Pb soldering systems. This series has a Moisture Sensitivity Level (MSL) 2.

For further information, please visit www.murata-ps.com/rohs

EFFICIENCY v LOAD GRAPHS (NNL10 $V_{NOM} = 4.0VDC$)

$V_{OUT} = 0.9V$

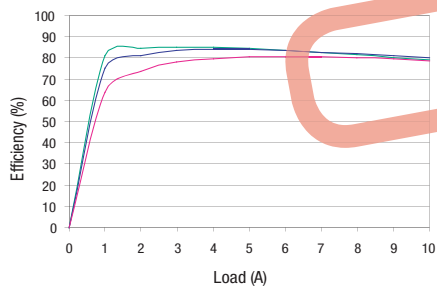

$V_{OUT} = 1.0V$

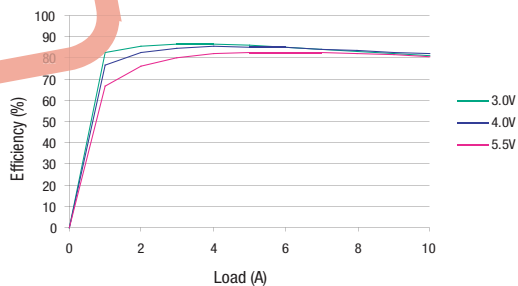

OBSOLETE

$V_{OUT} = 1.2V$

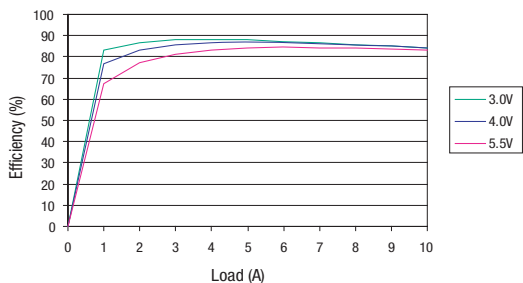

$V_{OUT} = 1.5V$

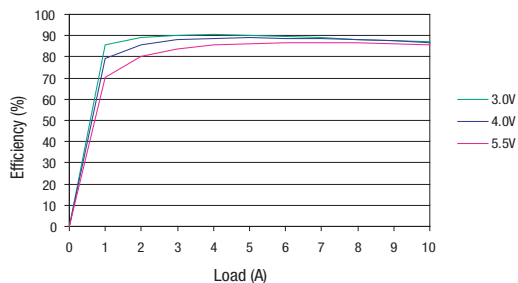

$V_{OUT} = 1.8V$

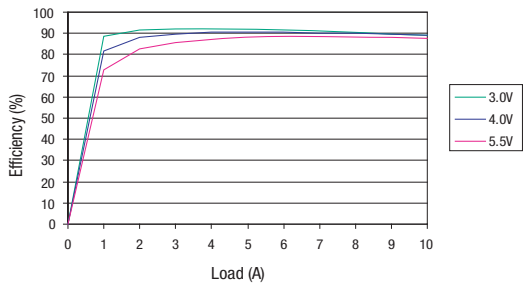

$V_{OUT} = 2.0V$

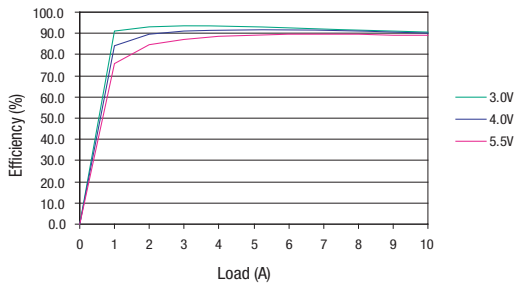

$V_{OUT} = 2.5V$

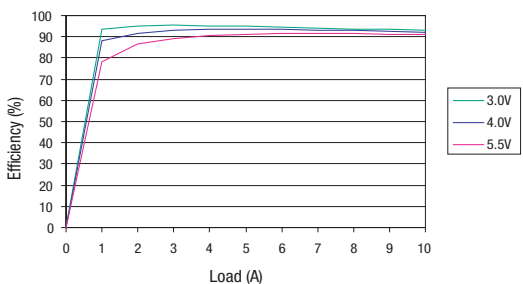

$V_{OUT} = 3.3V$

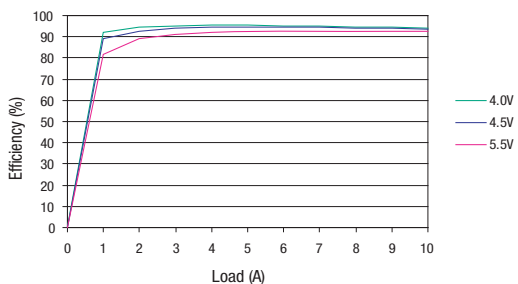

THERMAL DERATING GRAPHS (NNL10 $V_{NOM} = 4.0V_{DC}$)

$V_{OUT} = 0.9V$

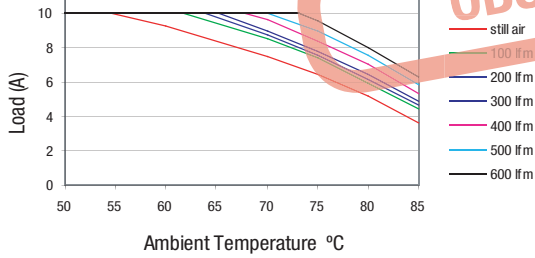

$V_{OUT} = 1.0V$

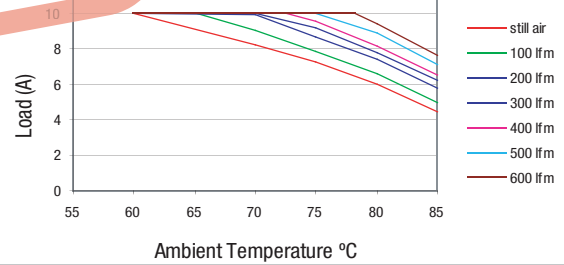

OBSOLETE

$V_{OUT} = 1.2V$

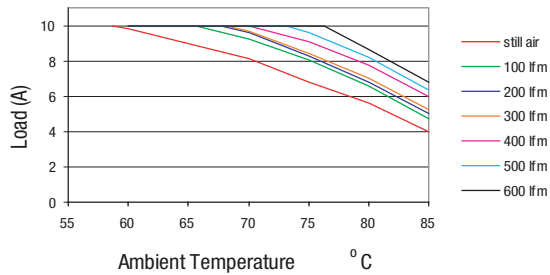

$V_{OUT} = 1.5V$

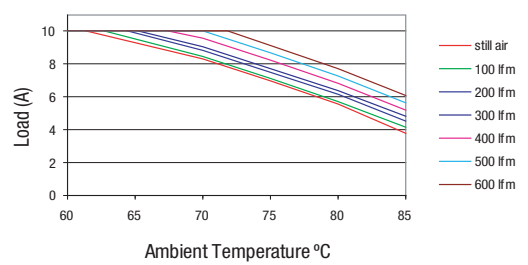

$V_{OUT} = 1.8V$

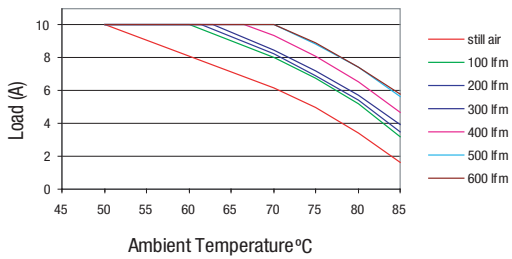

$V_{OUT} = 2.0V$

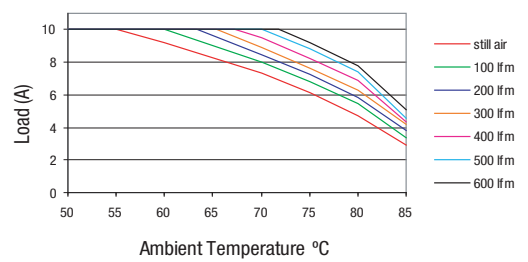

$V_{OUT} = 2.5V$

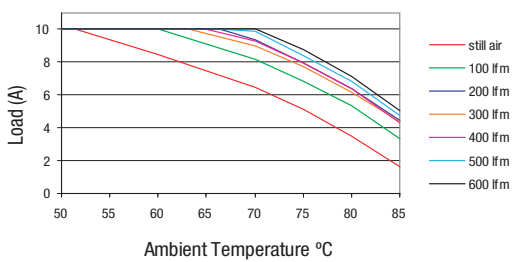

$V_{OUT} = 3.3V$

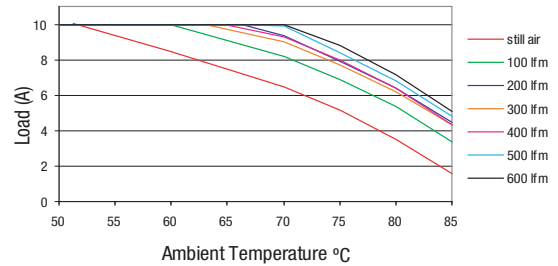

TYPICAL CHARACTERISTICS

OUTPUT RIPPLE & NOISE

$V_{IN} = 4.75V_{DC}$ $V_{OUT} = 3.3V_{DC}$ $I_{OUT} = 10.0A$

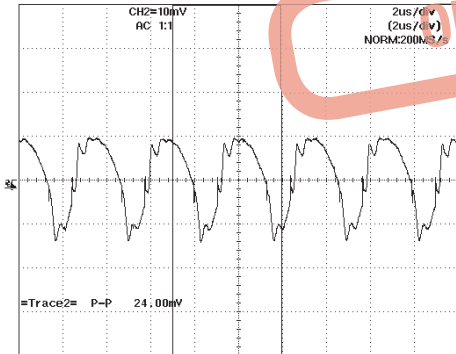

$V_{IN} = 4.0V_{DC}$ $V_{OUT} = 0.9V_{DC}$ $I_{OUT} = 10.0A$

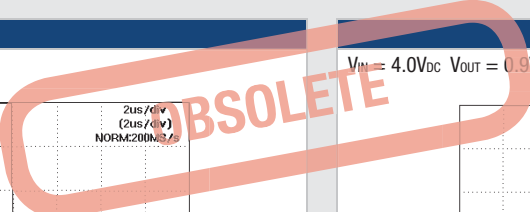
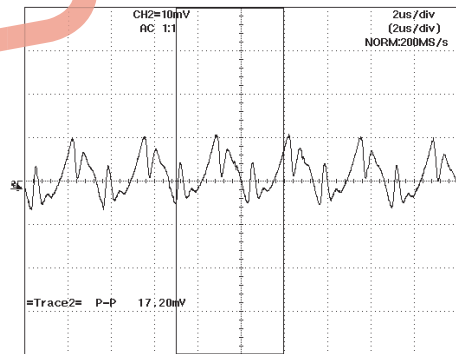

START-UP FROM APPLICATION OF V_{IN}

Tek **STOP** Single Seq 50kS/s

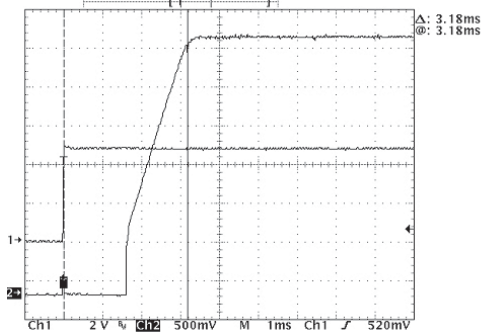

START-UP USING REMOTE ON/OFF

Response when remote on/off driven from an open collector output

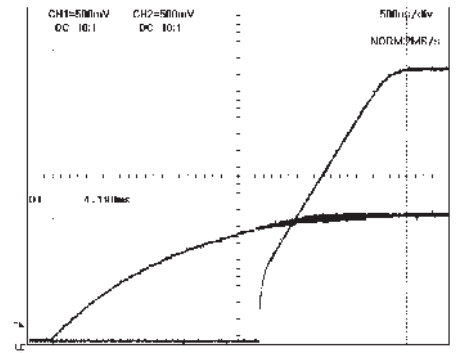

TRANSIENT RESPONSE

$V_{IN} = 4.0V_{DC}$ $V_{OUT} = 3.3V_{DC}$ I_{OUT} Change = 50-100%

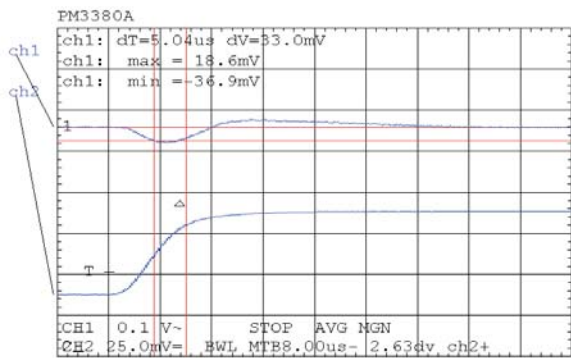

$V_{IN} = 4.0V_{DC}$ $V_{OUT} = 3.3V_{DC}$ I_{OUT} Change = 100-50%

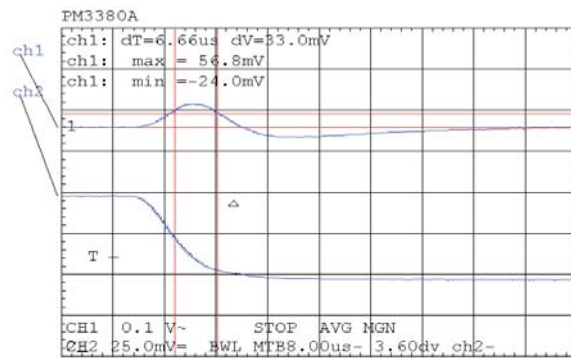

MECHANICAL DIMENSIONS

SURFACE MOUNT PACKAGE STYLE (BOTTOM VIEW)

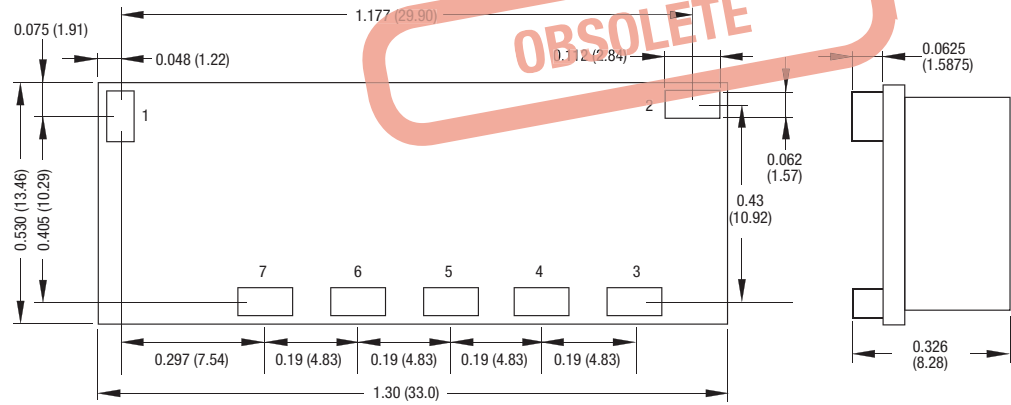

Weight: 5.7g

PIN CONNECTIONS

Pin	Function
1	On/Off
2	+V _{IN}
3	DC OK*
4	Common
5	+V _{OUT}
6	TRIM
7	SENSE

* Pin 3 (DC OK) is an optional pin feature which allows multiple NNL10 DC/DC converters to have sequenced outputs when used in conjunction with Remote ON/OFF pin (see application note for further information).

RECOMMENDED PAD LAYOUT

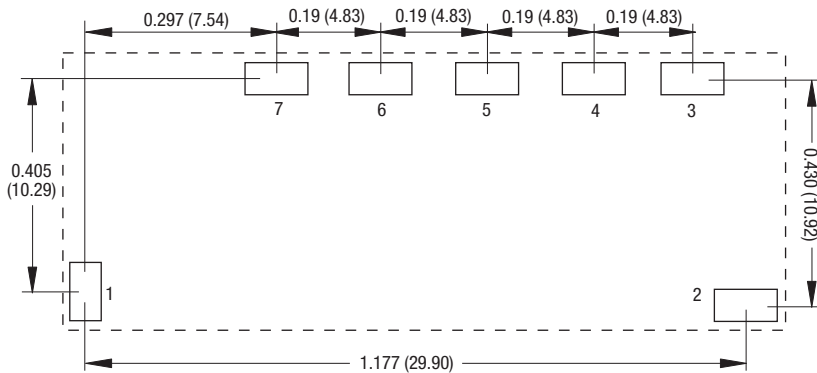

PAD SIZE
MIN: 0.140 X 0.095 (3.556 X 2.413)
MAX: 0.165 X 0.110 (4.19 X 2.79)

TRAY DIMENSIONS (TOP VIEW)

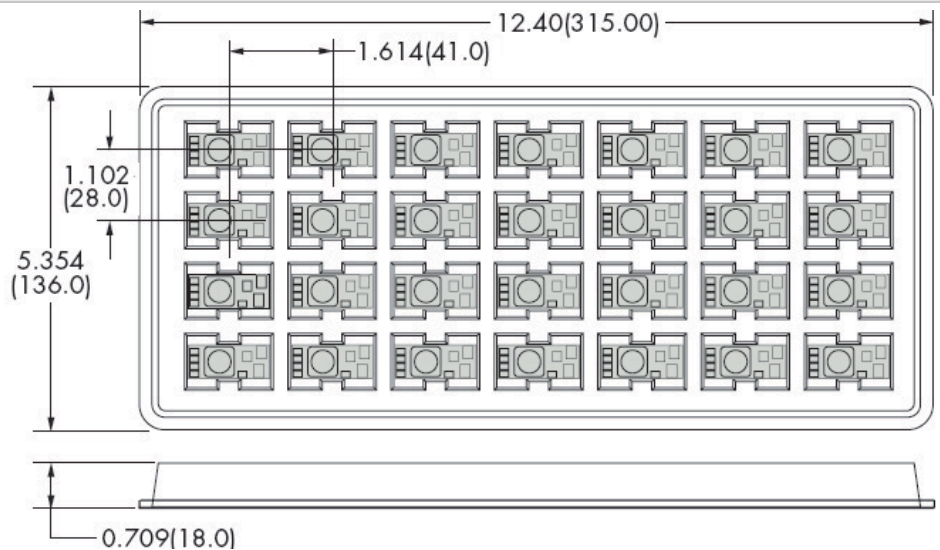

PICK-UP POINT

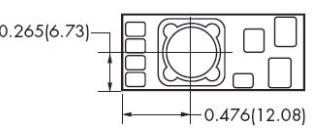

Tray quantity: 28
All dimensions ±0.0138 (0.35)

Unless otherwise stated all dimensions in inches (mm) ±0.01 (0.25).

TAPE & REEL SPECIFICATIONS

REEL OUTLINE DIMENSIONS

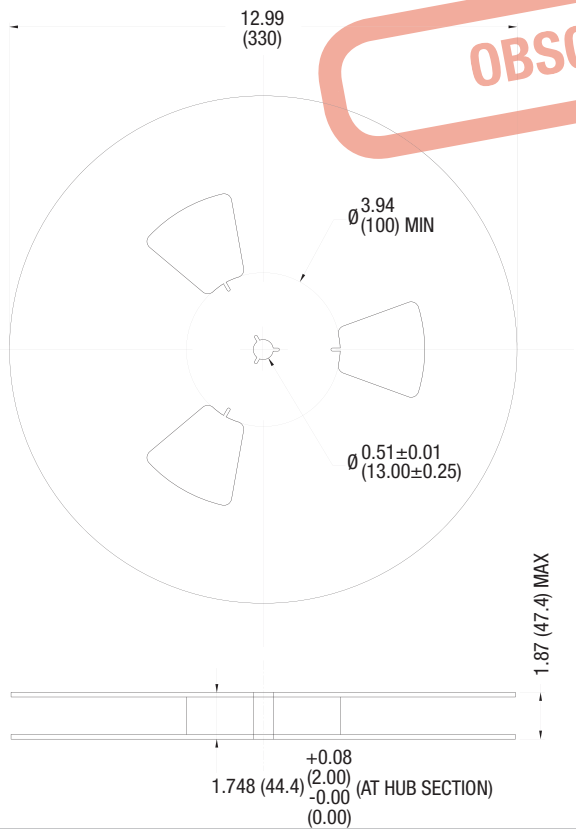

OBSOLETE

TAPE OUTLINE DIMENSIONS

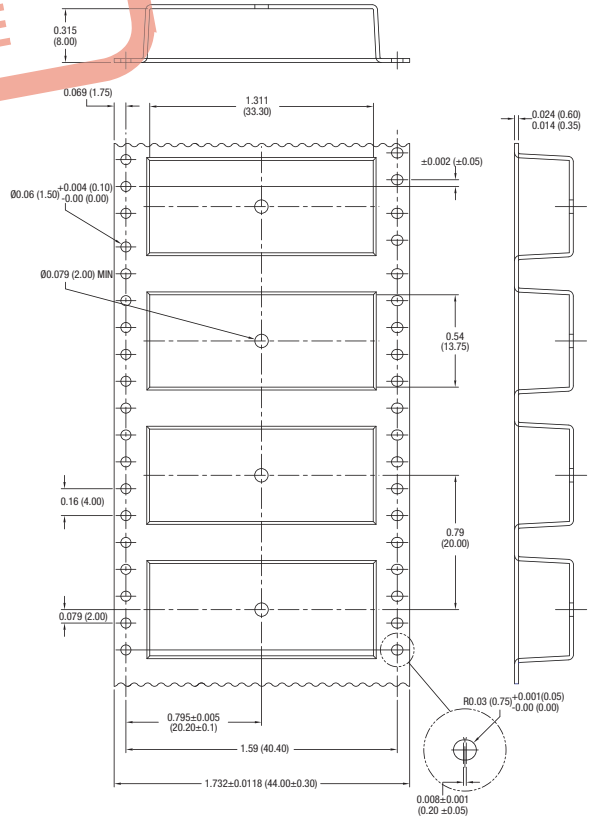

REEL PACKAGING DETAILS

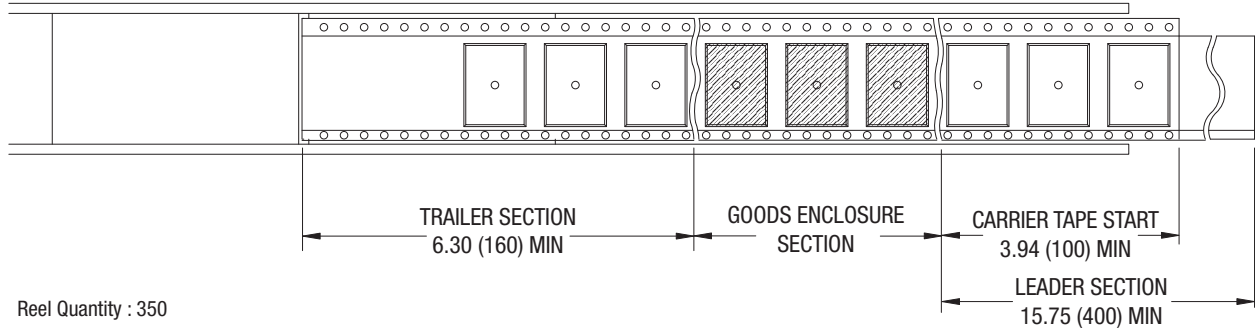

Murata Power Solutions, Inc.
11 Cabot Boulevard, Mansfield, MA 02048-1151 U.S.A.
ISO 9001 and 14001 REGISTERED

Murata Power Solutions, Inc. makes no representation that the use of its products in the circuits described herein, or the use of other technical information contained herein, will not infringe upon existing or future patent rights. The descriptions contained herein do not imply the granting of licenses to make, use, or sell equipment constructed in accordance therewith. Specifications are subject to change without notice.
© 2009 Murata Power Solutions, Inc.