

Single-Layer Microchip Capacitors/ Thin Film Circuit Substrates





EU RoHS Compliant

- All the products in this catalog comply with EU RoHS.
- EU RoHS is "the European Directive 2011/65/EU on the Restriction of the Use of Certain Hazardous Substances in Electrical and Electronic Equipment."
- For more details, please refer to our web page, "Murata's Approach for EU RoHS" (<https://www.murata.com/en-eu/support/compliance/rohs>).

Contents

Product specifications are as of March 2021.

Part Numbering	p2
<hr/>	
1 Single-Layer Microchip Capacitors (CLB Series)	p4
Single-electrode Type	p5
Temperature Compensating 5C Characteristics (0±30ppm/°C)	p5
Temperature Compensating 6U Characteristics (-750±120ppm/°C) ..	p6
High Dielectric B5 Characteristics (±10%)	p7
High Dielectric F9 Characteristics (+30%, -80%)	p8
High Dielectric W1 Characteristics (+30%, -90%)	p9
Multi-electrode Type	p10
<hr/>	
2 Thin Film Circuit Substrates (RU Series)	p11
<hr/>	
Specifications and Test Methods	p14
Notice	p16

Please check the MURATA website (<https://www.murata.com/>) if you cannot find a part number in this catalog.

Selection Guide

CLB Series: standard products specialized for capacitance

RU Series : custom products specialized for capacitance and resistance

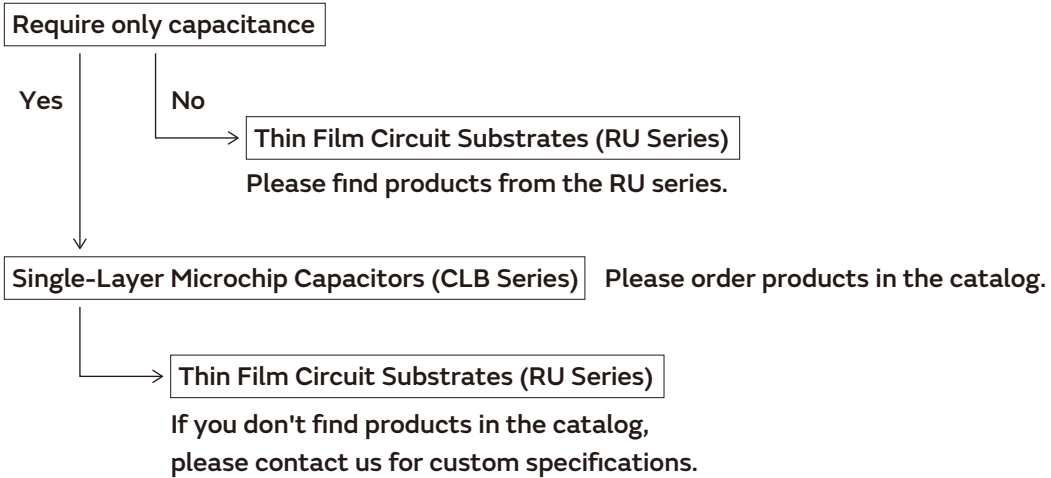

● Part Numbering

Single-Layer Microchip Capacitors (CLB Series)

(Part Number)

CL	B	05	B5	390	K	1	000	TC1
①	②	③	④	⑤	⑥	⑦	⑧	⑨

① Product ID

Product ID	
CL	Microchip Capacitors

② Series

Code	Series
B	Gaps on Both Sides

③ Size

Code	Dimensions (L x W)
0A	0.25 x 0.25mm
0B	0.30 x 0.25mm
0C	0.35 x 0.25mm
0D	0.38 x 0.38mm
0E	0.55 x 0.38mm
0H	0.71 x 0.38mm
05	0.50 x 0.50mm
0G	0.70 x 0.50mm
0K	0.90 x 0.50mm
0F	0.64 x 0.64mm
1A	1.00 x 0.64mm
0J	0.76 x 0.76mm
1B	1.09 x 0.76mm
09	0.90 x 0.90mm
1E	1.49 x 0.90mm
1C	1.27 x 1.27mm
1G	1.73 x 1.27mm
2C	2.19 x 1.27mm
1H	1.78 x 1.78mm
2L	2.95 x 1.78mm
2E	2.29 x 2.29mm
3G	3.71 x 2.29mm

④ Temperature Characteristics

Code	Temperature Range	Capacitance Change
5C	-25 to 85°C	0±30ppm/°C
6U	-25 to 85°C	-750±120ppm/°C
B5	-25 to 85°C	±10%
F9	-25 to 85°C	+30, -80%
W1	-25 to 85°C	+30, -90%

*Reference Temp.: 25°C

⑤ Capacitance

Expressed by three figures. The unit is pico-farad (pF). The first and second figures are significant digits, and the third figure expresses the number of zeros that follow the two numbers. If there is a decimal point, it is expressed by the capital letter "R." In this case, all figures are significant digits.

⑥ Capacitance Tolerance

Code	Capacitance Tolerance
B	±0.1pF
K	±10%
M	±20%
Z	+80%, -20%

⑦ Number of Electrodes

Code	Number of Electrodes
1	1
3	3
4	4
5	5

⑧ Individual Specification Code

Code	Individual Specification Code
000	Standard

⑨ Packaging

Code	Packaging
TC1	Tray
ZB	Expand Ring

Thin Film Circuit Substrates (RUSUB)

(Part Number)



① Product ID

Product ID	
RU	Thin Film Circuit Substrates

② Representative Characteristics

Code	Representative Characteristics
C	Capacitance
R	Resistance
D	Dimensions

③ Substrate Materials

Code	ϵr
N	9
A	10
H	39
K	90
U	150
F	250
Y	3000
Z	10000
X	15000
Q	30000

Substrate material code: A=Alumina, N=Aluminum Nitride
 ϵr : Dielectric Constant (Reference)

④ Metallization Materials

Indicated by 1 alphabetical character.

⑤ Characteristic Values

Representative characteristics are indicated by 4 digit alphanumeric characters.

⑥ Individual Specification Code

Indicated by 5 alphanumeric characters.

⑦ Other Specifications

Indicated by 2 alphabetical characters.

⑧ Packaging

Code	Packaging
TC	Tray
ZB	Expand Ring

Single-Layer Microchip Capacitors

CLB Series

Features

1. Simple single-layer structure combined with fine-grained high-density ceramic, and pure gold electrode provides very reliable performance and excellent frequency characteristics.
2. A wide selection of sizes from very miniature 0.25mm square is suited to high-density mounting.
3. By utilizing gold electrodes, die bonding with AuSn and wire bonding with gold wire are possible.
4. To improve handling of bonding, AuSn coating is available on one side or both sides.
5. Custom specifications (dimensions, cap. values, etc.) are also available upon request.

Applications

Microwave integrated circuits, microwave devices, optical devices, optical transceivers, TOSA/ROSA modules, measuring equipment, etc.

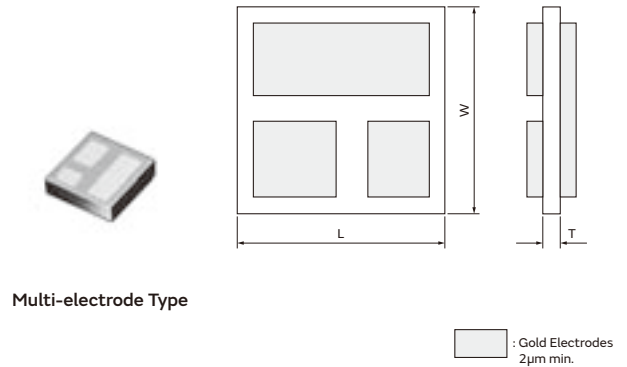
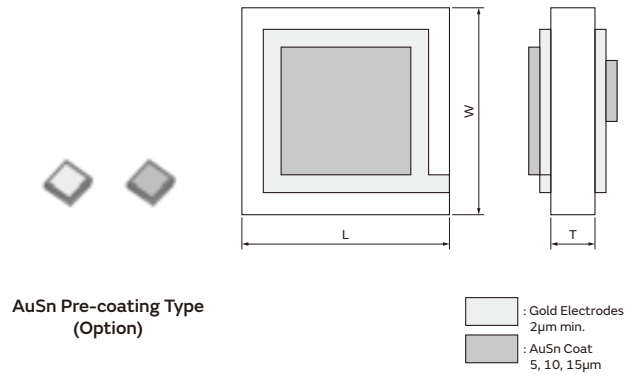
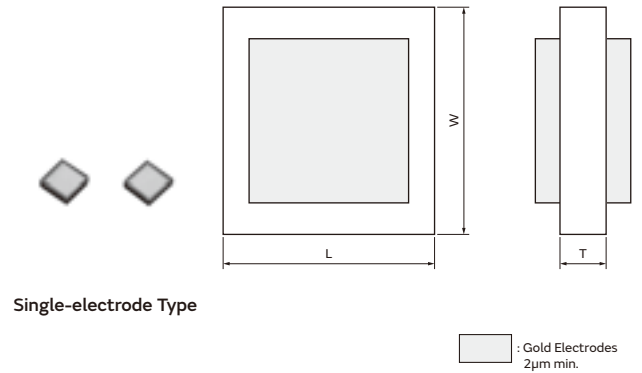

Single-electrode Type

Temperature Compensating 5C Characteristics (0±30ppm/°C)

Part Number	CLB																			
Size Code	0A	0C	0D	05	0E	0F	0G	0H	0J	09	1A	1B	1C	1E	1G	1H	2C	2E	2L	3G
L	0.25	0.35	0.38	0.50	0.55	0.64	0.70	0.71	0.76	0.90	1.00	1.09	1.27	1.49	1.73	1.78	2.19	2.29	2.95	3.71
W	0.25	0.25	0.38	0.50	0.38	0.64	0.50	0.38	0.76	0.90	0.64	0.76	1.27	0.90	1.27	1.78	1.27	2.29	1.78	2.29
T (max.)	0.35	0.35	0.35	0.35	0.35	0.35	0.35	0.35	0.35	0.35	0.35	0.35	0.35	0.35	0.35	0.45	0.45	0.45	0.45	0.45
Capacitance and Tolerance																				
0.1pF (0R1)	B																			
0.2pF (0R2)		B	B																	
0.3pF (0R3)			B	B																
0.4pF (0R4)			B	B																
0.5pF (0R5)				B	B															
0.6pF (0R6)				B	B	B														
0.7pF (0R7)						B	B	B												
0.8pF (0R8)						B	B	B												
0.9pF (0R9)						B	B		B											
1.0pF (1R0)						K	K		K	K										
1.1pF (1R1)									K	K	K									
1.2pF (1R2)									K	K	K									
1.3pF (1R3)									K	K	K									
1.5pF (1R5)										K	K	K								
1.6pF (1R6)										K	K	K								
1.8pF (1R8)										K		K								
2.0pF (2R0)												K		K						
2.2pF (2R2)													K	K						
2.4pF (2R4)													K	K						
2.7pF (2R7)													K	K						
3.0pF (3R0)													K							
3.3pF (3R3)													K							
3.6pF (3R6)													K							
3.9pF (3R9)														K	K					
4.3pF (4R3)														K	K					
4.7pF (4R7)														K	K					
5.1pF (5R1)															K	K				
5.6pF (5R6)															K					
6.2pF (6R2)															K		K			
6.8pF (6R8)															K		K			
7.5pF (7R5)																	K	K		
8.2pF (8R2)																	K	K		
9.1pF (9R1)																	K	K		
10pF (100)																	K	K		
11pF (110)																				K
12pF (120)																				K
13pF (130)																				K
15pF (150)																				K
16pF (160)																				K

Custom capacitors (dimensions, capacitance, etc.) are available upon request. Please contact us for details.

The characters shown in parentheses () following capacitance are part numbering codes.

Dimensions are shown in mm.

Capacitance Tolerance B: ±0.1pF, K: ±10%

Temperature Compensating 6U Characteristics (-750±120ppm/°C)

Part Number	CLB																
Size Code	0A	0B	0C	0D	05	0E	0F	0G	0H	0J	09	1A	1B	1C	1E	1H	2E
L	0.25	0.30	0.35	0.38	0.50	0.55	0.64	0.70	0.71	0.76	0.90	1.00	1.09	1.27	1.49	1.78	2.29
W	0.25	0.25	0.25	0.38	0.50	0.38	0.64	0.50	0.38	0.76	0.90	0.64	0.76	1.27	0.90	1.78	2.29
T (max.)	0.35	0.35	0.35	0.35	0.35	0.35	0.35	0.35	0.35	0.35	0.35	0.35	0.35	0.35	0.35	0.45	0.45
Capacitance and Tolerance																	
0.3pF (0R3)	B																
0.4pF (0R4)	B																
0.5pF (0R5)	B																
0.6pF (0R6)	B																
0.7pF (0R7)	B																
0.8pF (0R8)		B															
0.9pF (0R9)			B	B													
1.0pF (1R0)				K	K												
1.1pF (1R1)				K	K												
1.2pF (1R2)				K	K												
1.3pF (1R3)				K	K												
1.5pF (1R5)				K	K												
1.6pF (1R6)				K	K												
1.8pF (1R8)					K	K											
2.0pF (2R0)					K	K	K										
2.2pF (2R2)					K	K	K										
2.4pF (2R4)					K	K	K										
2.7pF (2R7)							K	K	K								
3.0pF (3R0)							K	K		K							
3.3pF (3R3)							K			K	K						
3.6pF (3R6)							K			K	K						
3.9pF (3R9)							K			K	K						
4.3pF (4R3)							K			K	K						
4.7pF (4R7)										K	K	K					
5.1pF (5R1)										K	K	K					
5.6pF (5R6)										K	K	K					
6.2pF (6R2)										K	K	K					
6.8pF (6R8)											K		K				
7.5pF (7R5)													K	K	K		
8.2pF (8R2)														K	K		
9.1pF (9R1)														K	K		
10pF (100)														K			
11pF (110)														K			
12pF (120)														K			
13pF (130)														K		K	
15pF (150)														K		K	
20pF (200)																	K

Custom capacitors (dimensions, capacitance, etc.) are available upon request. Please contact us for details.
 The characters shown in parentheses () following capacitance are part numbering codes.
 Dimensions are shown in mm.
 Capacitance Tolerance B: ±0.1pF, K: ±10%

High Dielectric B5 Characteristics (±10%)

Part Number	CLB																
Size Code	0A	0B	0C	0D	05	0E	0F	0G	0H	0J	09	1A	1C	1E	1G	1H	2E
L	0.25	0.30	0.35	0.38	0.50	0.55	0.64	0.70	0.71	0.76	0.90	1.00	1.27	1.49	1.73	1.78	2.29
W	0.25	0.25	0.25	0.38	0.50	0.38	0.64	0.50	0.38	0.76	0.90	0.64	1.27	0.90	1.27	1.78	2.29
T (max.)	0.35	0.35	0.35	0.35	0.35	0.35	0.35	0.35	0.35	0.35	0.35	0.35	0.35	0.35	0.35	0.45	0.45
Capacitance and Tolerance																	
5.6pF (5R6)	K																
6.2pF (6R2)	K																
6.8pF (6R8)	K																
7.5pF (7R5)	K																
8.2pF (8R2)	K																
9.1pF (9R1)	K																
10pF (100)	K																
11pF (110)	K																
12pF (120)	K																
13pF (130)		K															
15pF (150)		K															
16pF (160)			K														
18pF (180)			K	K													
20pF (200)				K													
22pF (220)				K	K												
24pF (240)				K	K												
27pF (270)				K	K												
30pF (300)				K	K												
33pF (330)					K	K											
36pF (360)					K	K											
39pF (390)					K	K											
43pF (430)					K	K	K										
47pF (470)							K	K	K								
51pF (510)							K	K	K								
56pF (560)							K	K	K								
62pF (620)							K	K									
68pF (680)							K	K		K	K						
75pF (750)							K			K	K						
82pF (820)										K	K	K					
91pF (910)										K	K	K					
100pF (101)										K	K	K					
110pF (111)										K	K	K					
120pF (121)											K	K					
130pF (131)											K						
150pF (151)																	K
160pF (161)													K	K			
180pF (181)													K				
200pF (201)													K				
300pF (301)																K	K
330pF (331)																	K
360pF (361)																	K
390pF (391)																	K
430pF (431)																	K
470pF (471)																	K
510pF (511)																	K
560pF (561)																	K
620pF (621)																	K

Custom capacitors (dimensions, capacitance, etc.) are available upon request. Please contact us for details.

The characters shown in parentheses () following capacitance are part numbering codes.

Dimensions are shown in mm.

Capacitance Tolerance K: ±10%

High Dielectric F9 Characteristics (+30%, -80%)

Part Number	CLB											
Size Code	0A	0B	0C	0D	05	0E	0F	0G	0H	0J	09	1A
L	0.25	0.30	0.35	0.38	0.50	0.55	0.64	0.70	0.71	0.76	0.90	1.00
W	0.25	0.25	0.25	0.38	0.50	0.38	0.64	0.50	0.38	0.76	0.90	0.64
T (max.)	0.35	0.35	0.35	0.35	0.35	0.35	0.35	0.35	0.35	0.35	0.35	0.35
Capacitance and Tolerance												
27pF (270)	M											
30pF (300)	M											
33pF (330)	M											
36pF (360)		M										
39pF (390)		M										
43pF (430)			M									
47pF (470)			M									
51pF (510)			M									
62pF (620)				M								
68pF (680)				M								
75pF (750)				M	M							
82pF (820)				M	M							
91pF (910)					M	M						
100pF (101)					M	M						
110pF (111)					M	M						
120pF (121)					M	M						
130pF (131)					M		M		M			
150pF (151)							M	M	M			
160pF (161)							M	M				
180pF (181)							M	M				
200pF (201)							M	M		M	M	
220pF (221)							M			M	M	
240pF (241)										M	M	M
270pF (271)										M	M	M
300pF (301)										M	M	M
330pF (331)											M	M
360pF (361)											M	M
390pF (391)											M	

Custom capacitors (dimensions, capacitance, etc.) are available upon request. Please contact us for details.

The characters shown in parentheses () following capacitance are part numbering codes.

Dimensions are shown in mm.

Capacitance Tolerance M: ±20%

High Dielectric W1 Characteristics (+30%, -90%)

Part Number	CLB					
Size Code	0A	0D	05	0F	0J	09
L	0.25	0.38	0.50	0.64	0.76	0.90
W	0.25	0.38	0.50	0.64	0.76	0.90
T (max.)	0.35	0.35	0.35	0.35	0.35	0.35
Capacitance and Tolerance						
36pF (360)	Z					
39pF (390)	Z					
43pF (430)	Z					
47pF (470)	Z					
51pF (510)	Z					
56pF (560)	Z					
91pF (910)		Z				
100pF (101)		Z				
110pF (111)		Z				
120pF (121)		Z				
130pF (131)		Z	Z			
150pF (151)		Z	Z			
160pF (161)			Z			
180pF (181)			Z			
200pF (201)			Z			
220pF (221)			Z	Z		
240pF (241)				Z		
270pF (271)				Z		
300pF (301)				Z		
330pF (331)				Z	Z	
360pF (361)				Z	Z	
390pF (391)				Z	Z	Z
430pF (431)					Z	Z
470pF (471)					Z	Z
510pF (511)					Z	Z
560pF (561)					Z	Z
620pF (621)						Z
680pF (681)						Z

Custom capacitors (dimensions, capacitance, etc.) are available upon request. Please contact us for details.

The characters shown in parentheses () following capacitance are part numbering codes.

Dimensions are shown in mm.

Capacitance Tolerance Z: +80%, -20%

Multi-electrode Type

Part Number	Dimensions (mm)	Capacitance (pF)	Temperature Coefficient	Rated Voltage (Vdc)
CLB056U0R7K3000TC1	L 0.50 x W 0.50 x T(max.) 0.35	0.7	-750±120 ppm/°C	100
CLB0K6U1R5K4000TC1	L 0.90 x W 0.50 x T(max.) 0.35	1.5	-750±120 ppm/°C	100
CLB096U3R0K5000TC1	L 0.90 x W 0.90 x T(max.) 0.35	3.0	-750±120 ppm/°C	100

Custom capacitors (dimensions, capacitance, etc.) are available upon request. Please contact us for details.

Capacitance Tolerance K: ±10%

The above capacitance values are of the largest electrodes.

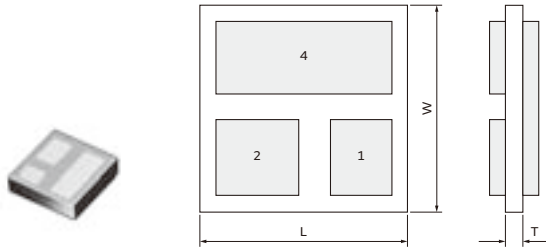

Multi-electrode Type
CLB056U0R7K3000TC1

 : Gold Electrodes
 2µm min.

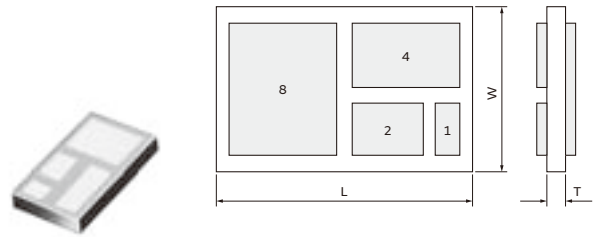

Multi-electrode Type
CLB0K6U1R5K4000TC1

 : Gold Electrodes
 2µm min.

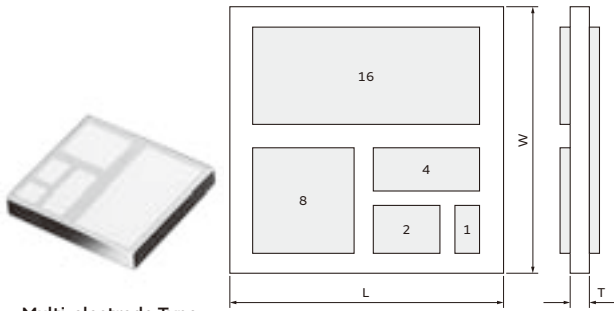

Multi-electrode Type
CLB096U3R0K5000TC1

 : Gold Electrodes
 2µm min.

Thin Film Circuit Substrates (RUSUB)

RU Series

Features

1. High Q value and high dielectric constant material enables low insertion loss and miniaturization of the device.
2. A wide selection of substrate materials meets customer's requirements.
3. Metallization process suitable for each substrate material achieves excellent reliability.
4. By utilizing gold electrodes, die bonding with AuSn and wire bonding with gold wire are possible.
5. Thin film microfabrication technology allows precise micro pattern.
6. Through hole via and AuSn pre-coating are available.
7. CR composite products are also available by combining high dielectric capacitor and thin film resistor.

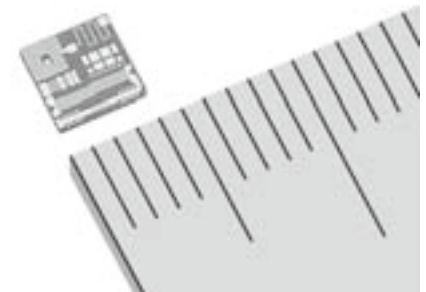

Pic. 1

Main Applications

Devices for microwave, millimeter wave and optical communication, MIC circuit substrates, impedance matching circuit substrates, bypass circuit substrates, couplers, filters, capacitors, capacitor networks, resistor networks, etc.

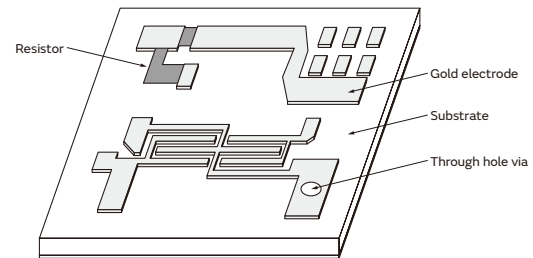

Fig. 1

Substrate Characteristics and General Specifications

Table 1. Substrate Characteristics and General Specifications

Substrate Material Code	Dielectric Constant (εr) *1	Size min. (L×W×T) (mm) *2	Capacity Temperature Characteristics (ppm/°C) *3	Through Hole	TaN Resistance	L/S min. (μm) *4	Coefficient of Thermal Expansion (ppm/°C) *1	Temperature Conductivity (W/(m·°C)) *1
N	9	0.25×0.25×0.10	—	○	○	30/30 (Au thickness 4μm) 50/50 (Au thickness 8μm)	4.6	200.0
A	10	0.25×0.25×0.20	—	○	○		7.0	33.5
H	39	0.25×0.25×0.10	0±30	×	○		6.6	1.9
K	90	0.25×0.25×0.10	-330±120	×	○		9.2	2.3
U	150	0.25×0.25×0.10	-750±120	×	○		11.7	2.0
F	250	0.25×0.25×0.10	-750±600	×	○		12.2	4.0
Y	3000	0.25×0.25×0.10	±10%	×	○		10.7	2.5
Z	10000	0.25×0.25×0.10	+30, -80%	×	×		10.5	1.6
X	15000	0.25×0.25×0.10	+30, -90%	×	×		14.0	2.4
Q	30000	0.25×0.25×0.25	±25%	×	○		11.2	7.35

*1 Typical value

*2 L = length, W = width, T = thickness

*3 Temperature Range: -25 to 85°C, Reference Temperature: 25°C

*4 L = line, S = space

Resistor Specifications

Table 2. Resistor Specifications

Material	TaN
Sheet Resistance (Ω)	12.5, 25, 50
Operating Temperature Range ($^{\circ}\text{C}$)	-55 to 125
Rated Voltage (mW/mm ²)	100
Resistance Tolerance (%) *	± 20
Resistance Temperature Coefficient (ppm/ $^{\circ}\text{C}$)	-70 \pm 50

* Please contact us for smaller resistor tolerance.

Through Hole Via Specifications

Table 3. Through Hole Via Specifications

a: Hole to Hole (mm)	0.22 min.
b: Distance between Hole and Electrode (mm)	0.10 min.
c: Distance between Electrode and Chip Edge (mm)	0.15 min.

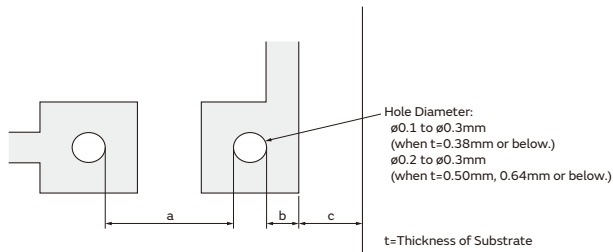

Fig. 2 Through Hole Via Diameter

AuSn Pre-coating Type

Table 4. AuSn Pre-coating Specifications

1. AuSn Pre-coating Thickness	5 \pm 2 μm , 10 \pm 3 μm , 15 \pm 4 μm
2. Coating Size	Min 150 μm \square $\pm 10\mu\text{m}$ (5 μm Thickness) Min 150 μm \square $\pm 20\mu\text{m}$ (10, 15 μm Thickness)
3. AuSn Electrode Offset (Top Side)	$\geq 25\mu\text{m}$
4. AuSn Electrode Offset (Bottom Side)	$\geq 50\mu\text{m}$

Au Electrode

Table 5. Au Electrode Specifications

Thickness	4 μm	8 μm
Dimension Tolerance	$\pm 10\mu\text{m}$	$\pm 15\mu\text{m}$
Offset	50 μm (from chip edge)	

* 15 μm thickness is also available upon request.

Note

Data sending method: When requiring our product, please send pattern by CAD data and information to our local sales.

Table 6. Information of Sending Data

CAD Data Format	DXF, DWG
-----------------	----------

Examples of RUSUB Offering

- Twelve types of standard products of RUSUB C+R (Capacitor + Resistor) are available.
- The custom substrate dimensions, capacitance, resistance value, and electrode pattern shape are also available upon request.

Part Number	Dimensions	Thickness	Capacitance	Resistance
RUCYT101K00009GNTC	1.0mm×0.5mm	0.11 ±0.025mm	100pF ±10%	50Ω ±20%
RUCYT101K00011GNTC	1.0mm×0.5mm	0.11 ±0.025mm	100pF ±10%	100Ω ±20%
RUCYT101K00012GNTC	1.0mm×0.5mm	0.11 ±0.025mm	100pF ±10%	200Ω ±20%
RUCYT201K00010GNTC	1.0mm×1.0mm	0.12 ±0.025mm	200pF ±10%	50Ω ±20%
RUCYT201K00013GNTC	1.0mm×1.0mm	0.12 ±0.025mm	200pF ±10%	100Ω ±20%
RUCYT201K00014GNTC	1.0mm×1.0mm	0.12 ±0.025mm	200pF ±10%	200Ω ±20%

Part Number	Dimensions (a)	Thickness	Capacitance
RUCQD101RCC007GNTC	0.34 ±0.10mm	0.25 ±0.01mm	100pF +60%/-20%
RUCQD431RCC001GNZB	0.70 ±0.20mm	0.25 ±0.01mm	430pF +60%/-20%
RUCQD471RCC002GNZB	0.73 ±0.20mm	0.25 ±0.01mm	470pF +60%/-20%
RUCQD511RCC003GNZB	0.76 ±0.25mm	0.25 ±0.01mm	510pF +60%/-20%
RUCQD561RCC004GNZB	0.80 ±0.25mm	0.25 ±0.01mm	560pF +60%/-20%

Part Number	Dimensions	Thickness	Capacitance
RUCQD201ZCC005GNZB	1.1mm×0.6mm	0.25 ±0.01mm	200pF×4

Shape

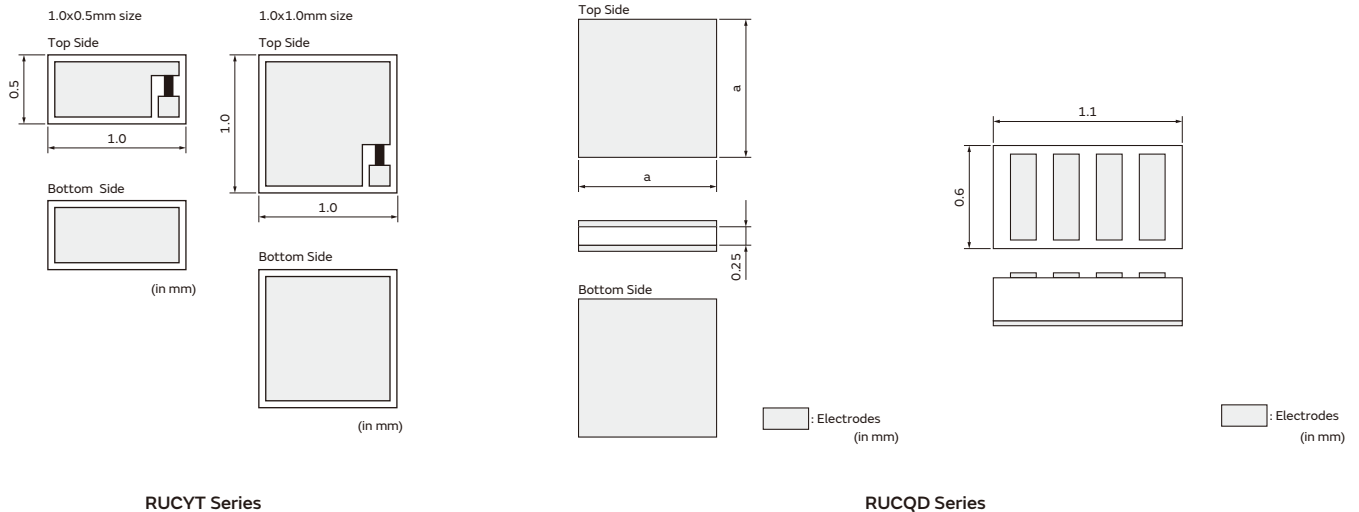

Specifications and Test Methods

No.	Item	Specifications	Test Methods												
1	Operating Temperature Range	-55 to 125°C													
2	Appearance	No lifting No scratch that exposes the ceramic material	Microscope at 20x magnification												
3	Rated Voltage	100Vdc (except Q) 65Vdc (Q)													
4	Capacitance	Within the specified tolerance	MIL-STD-202 Method 305 Measurement Frequency: Temp. Comp.: 1MHz±10% High Dielectric: 1kHz±10% Measurement Voltage: 1Vrms												
5	Q/Dissipation Factor (D. F.)	H, 5C: Q≥200 K, U, F, 6U: Q≥100 Y, Z, B5, F9: D. F.≤2.5% X, Q, W1: D. F.≤4%	MIL-STD-202 Method 306 Test frequency and voltage are the same as those of the capacitance test.												
6	Insulation Resistance (I. R.)	25°C: 10000MΩ min. (except Q) 100MΩ min. (Q) 125°C: 10000MΩ min. (except Q) 10MΩ min. (Q)	MIL-STD-202 Method 302 Measurement Voltage: Rated Voltage Measurement Temperature: 25±2°C and 125±2°C Measurement Time: Within 2 minutes												
7	Dielectric Withstanding Voltage (D. W. V.)	Satisfies the following performance	MIL-STD-202 Method 301 Measurement Voltage: 250Vdc (except Q) 162.5Vdc (Q) Applied Time: 1 to 5 seconds Charge/Discharge Current: 50mA max.												
8	Temperature Characteristics (Temperature Coefficient)	H, 5C: 0±30ppm/°C K: -330±120ppm/°C U, 6U: -750±120ppm/°C F: -750±600ppm/°C Y, B5: ±10% Z, F9: +30, -80% X, W1: +30, -90% Q: ±25%	The capacitance change should be measured at each specified temperature stage. <table border="1" style="margin-left: auto; margin-right: auto;"> <thead> <tr> <th>Step</th> <th>Temp (°C)</th> </tr> </thead> <tbody> <tr> <td>1</td> <td>25±2</td> </tr> <tr> <td>2</td> <td>-25±3</td> </tr> <tr> <td>3</td> <td>25±2</td> </tr> <tr> <td>4</td> <td>85±3</td> </tr> <tr> <td>5</td> <td>25±2</td> </tr> </tbody> </table>	Step	Temp (°C)	1	25±2	2	-25±3	3	25±2	4	85±3	5	25±2
Step	Temp (°C)														
1	25±2														
2	-25±3														
3	25±2														
4	85±3														
5	25±2														
9	Mechanical Strength	Bond Strength	MIL-STD-883 Method 2011Condition D Mount the capacitors on a gold metallized alumina substrate with AuSn (80/20) and bond a 25μmø gold wire to the capacitor electrode using wedge bonding. Then, pull the wire.												
		Die Shear Strength	MIL-STD-883 Method 2019 Mount the capacitors on a gold metallized alumina substrate with AuSn (80/20). Apply force in the horizontal direction.												
10	Vibration	Appearance	MIL-STD-202 Method 201												
		Capacitance	Type of Vibration: 10 to 55 to 10Hz (1 min) Total Amplitude: 1.5mm												
		Q/D. F.	This motion should be applied for a period of 2h in each of 3 mutually perpendicular directions (total of 6h).												
11	Thermal Shock	Appearance	MIL-STD-202 Method 107Condition A-1												
		Capacitance Change	Note : Temperature in Step 3: 125±3 °C Test time in Step 1 and 3: 30 min												
		Q/D. F.	Exposure Time: H, K, U, F, Q, 5C, 6U: 24±2h B5, F9, W1, Y, Z, X: 48±4h												
		I. R.													
		D. W. V.	Satisfies the specification "D. W. V"												
12	Humidity (No Load)	Appearance	MIL-STD-202 Method 103												
		Capacitance Change	Temperature: 60±5°C Humidity: 90 to 95%RH												
		Q/D. F.	Test Time: 1000±12h Exposure Time: H, K, U, F, Q, 5C, 6U: 24±2h B5, F9, W1, Y, Z, X: 48±4h												
		I. R.													
		D. W. V.	Satisfies the specification "D. W. V"												

Continued on the following page. ↗

Specifications and Test Methods

Continued from the preceding page. ↘

No.	Item	Specifications	Test Methods	
13	High Temperature Load	Appearance	MIL-STD-202 Method 108 Test Temperature: 125±3°C Applied Voltage: 200% x Rated Voltage Test Time: 1000±12h Exposure Time: H, K, U, F, Q, 5C, 6U: 24±2h B5, F9, W1, Y, Z, X: 48±4h	
		Capacitance Change		H, K, U, F, 5C, 6U: $\leq \pm 5\%$ or $\leq \pm 0.5\text{pF}$ (whichever is greater) B5, F9, W1, Y, Z, X, Q: $\leq \pm 10\%$
		Q/D. F.		H, K, U, F, 5C, 6U: $Q \geq 100$ Y, Z, B5, F9: D. F. $\leq 2.5\%$ X, Q, W1: D. F. $\leq 4\%$
		I. R.		$\geq 30\%$ of initial value (except Q) $\geq 10\%$ of initial value (Q)
		D. W. V.		Satisfies the specification "D. W. V"
14	Humidity Load	Appearance	MIL-STD-202 Method 103 Temperature: 85±2°C Humidity: 85±5%RH Bias Voltage: 1.5V±10% Test Time: 240h Exposure Time: H, K, U, F, Q, 5C, 6U: 24±2h B5, F9, W1, Y, Z, X: 48±4h	
		Capacitance Change		H, K, U, F, 5C, 6U: $\leq \pm 5\%$ or $\leq \pm 0.5\text{pF}$ (whichever is greater) B5, F9, W1, Y, Z, X, Q: $\leq \pm 10\%$
		Q/D. F.		H, K, U, F, 5C, 6U: $Q \geq 100$ Y, Z, B5, F9: D. F. $\leq 2.5\%$ X, Q, W1: D. F. $\leq 4\%$
		I. R.		10000MΩ min. (except Q) 10MΩ min. (Q)
		D. W. V.		Satisfies the specification "D. W. V"

Mounting for testing: The capacitors should be mounted on the substrate as shown below using die bonding and wire bonding when tests No. 10 to 14 are performed.

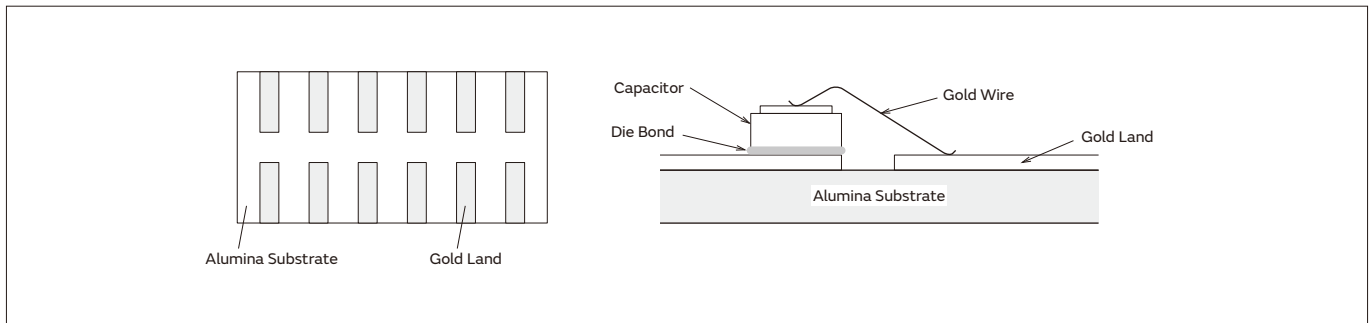

Notice

Notice

Please note the following conditions to retain the solderability of the products.

1. Store the products in the manufacturer's or a sealed box with the following conditions.
 - Temperature: -10 to 40°C without rapid change
 - Humidity: 30 to 70%RH
2. Avoid storing the products in the following conditions.
 - (a) Ambient air containing corrosive gas (chlorine gas, hydrogen sulfide gas, ammonia gas, sulfuric acid gas, nitric oxide gas, etc.)

- (b) Ambient air containing volatile or combustible gas
 - (c) In environments with a high concentration of airborne particles
 - (d) In liquid (water, oil, chemical solution, organic solvents, etc.)
 - (e) In environments prone to dew
 - (f) In direct sunlight
 - (g) In freezing environments
3. To retain solderability, do not touch the products directly with bare hands.

Notice (Soldering and Mounting)

1. Die Bonding

(1) Materials and bonding conditions

- Solders: Au-20%Sn
- Bonding temperature: 300 to 320°C
- Bonding time: Within 1 minute
- Bonding atmosphere: N₂ atmosphere

(2) Notice

- (a) Please mount the products with gentle scrubbing.
- (b) Die bonding condition is affected by what type of solder and base substrate are used.
Please evaluate die bonding condition in advance with the same materials as mass production materials and ensure that there is no effect, especially cracking of the ceramic.

2. Wire Bonding

(1) Materials and bonding conditions

- Wire lead: 25μmø gold wire (Au thickness: 4μm)
50μmø gold wire (Au thickness: 8μm)
- Bonding temperature: 150 to 250°C
- Bonding methods: Thermocompression or thermosonic bonding

(2) Notice

- (a) Please keep bonding more than 25 microns away from the edge of the electrode.

Please contact us for other bonding conditions not listed above.

Global Locations

For details please visit www.murata.com



⚠ Note

1 Export Control

For customers outside Japan:

Murata requests customers to ensure that no Murata products are used or sold, through any channels, for use in the design, development, production, utilization, maintenance or operation of, or otherwise contribution to Weapons of Mass Destruction (nuclear, chemical or biological weapons or missiles), conventional weapons, or items specially designed for them.

For customers in Japan:

For products which are controlled items subject to the "Foreign Exchange and Foreign Trade Law" of Japan, the export license specified by the law is required for export.

2 Please contact our sales representatives or product engineers before using the products in this catalog for the applications listed below, which require especially high reliability for the prevention of defects which might directly damage a third party's life, body or property, or when one of our products is intended for use in applications other than those specified in this catalog.

- ① Aircraft equipment
- ② Aerospace equipment
- ③ Undersea equipment
- ④ Power plant equipment
- ⑤ Medical equipment
- ⑥ Transportation equipment (vehicles, trains, ships, etc.)
- ⑦ Traffic signal equipment
- ⑧ Disaster prevention / crime prevention equipment
- ⑨ Data-processing equipment
- ⑩ Application of similar complexity and/or reliability requirements to the applications listed above

3 Product specifications in this catalog are as of March 2021. They are subject to change or our products in it may be discontinued without advance notice. Please check with our sales representatives or product engineers before ordering. If there are any questions, please contact our sales representatives or product engineers.

4 Please read rating and ⚠CAUTION (for storage, operating, rating, soldering, mounting and handling) in this catalog to prevent smoking and/or burning, etc.

5 This catalog has only typical specifications. Therefore, please approve our product specifications or transact the approval sheet for product specifications before ordering.

6 Please note that unless otherwise specified, we shall assume no responsibility whatsoever for any conflict or dispute that may occur in connection with the effect of our and/or a third party's intellectual property rights and other related rights in consideration of your use of our products and/or information described or contained in our catalogs. In this connection, no representation shall be made to the effect that any third parties are authorized to use the rights mentioned above under licenses without our consent.

7 No ozone depleting substances (ODS) under the Montreal Protocol are used in our manufacturing process.

Murata Manufacturing Co., Ltd.

www.murata.com

muRata
INNOVATOR IN ELECTRONICS