

Ceramic Resonators (CERALOCK)

Application Manual

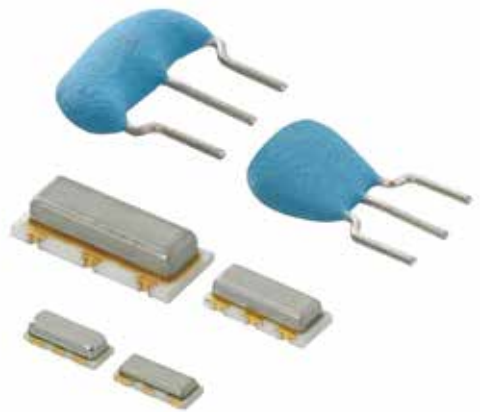

Introduction.....

Ceramic resonators (CERALOCK) are made of high stability piezoelectric ceramics that function as a mechanical resonator.

This device has been developed to function as a reference signal generator and the frequency is primarily adjusted by the size and thickness of the ceramic element.

With the advance of the IC technology, various equipment may be controlled by a single LSI integrated circuit, such as the one-chip microprocessor.

CERALOCK can be used as the timing element in most microprocessor based equipment.

In the future, more and more applications will use CERALOCK because of its high stability non-adjustment performance, miniature size and cost savings. Typical applications include TVs, VCRs, automotive electronic devices, telephones, copiers, cameras, voice synthesizers, communication equipment, remote controls and toys.

This manual describes CERALOCK and will assist you in applying it effectively.

EU RoHS Compliant

- All the products in this catalog comply with EU RoHS.
- EU RoHS is "the European Directive 2011/65/EU on the Restriction of the Use of Certain Hazardous Substances in Electrical and Electronic Equipment."
- For more details, please refer to our website 'Murata's Approach for EU RoHS' (<http://www.murata.com/en-eu/support/compliance/rohs>).

Contents

Product specifications are as of October 2019.

1	Characteristics and Types of CERALOCK	
	1. General Characteristics of CERALOCK	p2
	2. Types of CERALOCK.....	p3
	MHz Band lead CERALOCK (CSTLS Series)	p3
	MHz Band Chip CERALOCK(CSTCR/CSTNR/CSTNE Series) ...	p4
2	Principles of CERALOCK	
	1. Equivalent Circuit Constants.....	p6
	2. Basic Oscillation Circuits	p9
3	Specifications of CERALOCK	
	1. Electrical Specifications	p12
	Electrical Specifications of MHz Band Lead CERALOCK (CSTLS Series)	p12
	Electrical Specifications of MHz Band Chip CERALOCK (CSTCR/CSTNR/CSTNE Series)	p14
	2. Mechanical and Environmental Specifications of CERALOCK.....	p15
4	Applications of Typical Oscillation Circuits	
	1. Cautions for Designing Oscillation Circuits ...	p17
	2. Application to Various Oscillation Circuits ...	p18
	Application to C-MOS Inverter	p18
	Application to H-CMOS Inverter	p19
5	Characteristics of CERALOCK Oscillation Circuits	
	1. Stability of Oscillation Frequency	p20
	2. Characteristics of the Oscillation Level.....	p21
	3. Characteristics of Oscillation Rise Time	p22
	4. Starting Voltage.....	p23
6	Application Circuits to Various ICs/LSIs	
	1. Application to Microcomputers	p24
	Recommendable circuit constants examples of representative microcomputers	p25
7	Notice	p27
8	Appendix	
	Equivalent Circuit Constants of CERALOCK	p28

Please check the MURATA website (<http://www.murata.com/>) if you cannot find the part number in the catalog.

1 Characteristics and Types of CERALOCK

1. General Characteristics of CERALOCK

Ceramic resonators use the mechanical resonance of piezoelectric ceramics. (Generally, lead zirconium titanate: PZT.)

The oscillation mode varies with resonant frequency.

The table on the right shows this relationship.

As a resonator device, Crystal Unit is well-known. RC oscillation circuits and LC oscillation circuits are also used to produce electrical resonance. The following are the characteristics of CERALOCK.

① High stability of oscillation frequency:

Oscillation frequency stability is between that of Crystal Units and LC or RC oscillation circuits.

The temperature coefficient of Crystal Units is 10–6/ °C maximum and approximately 10–3 to 10–4/°C for LC or RC oscillation circuits. For comparison these, it is 10–5/°C at –20 to +80°C for ceramic resonators.

② Small configuration and light weight:

The ceramic resonator is half the size of popular Crystal Units.

③ Low price, non-adjustment:







CERALOCK is mass produced, resulting in low cost and high stability.

Unlike RC or LC circuits, ceramic resonators use mechanical resonance. This means it is not basically affected by external circuits or by the fluctuation of the supply voltage.

Highly stable oscillation circuits can therefore be made without the need of adjustment.

The table briefly describes the characteristics of various oscillator elements.

Vibration Mode and Frequency Range

Frequency (Hz)		1k	10k	100k	1M	10M	100M	1G
Vibration Mode								
1	Flexural mode 	█						
2	Length mode 			█				
3	Area expansion mode 			█				
4	Radius vibration 			█				
5	Shear thickness mode 				█			
6	Thickness expansion mode 				█			
7	Surface acoustic wave 					█		

[Note]: ←→ show the direction of vibration

Characteristics of Various Oscillator Elements

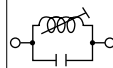
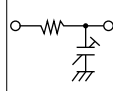
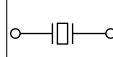
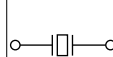
Name	Symbol	Price	Size	Adjustment	Oscillation Frequency Initial Tolerance	Long-term Stability
LC		lower cost	Big	Required	±2.0%	Fair
CR		lower cost	Small	Required	±2.0%	Fair
Crystal Unit		Expensive	Big	Not required	±0.001%	Excellent
Ceramic Resonator		Inexpensive	Small	Not required	±0.5%	Excellent

2. Types of CERALOCK

MHz Band lead CERALOCK (CSTLS Series)

As CSTLS series does not require externally mounted capacitors, the number of components can be reduced, allowing circuits to be made more compact.

The table shows the frequency range and appearance of the three-terminal CERALOCK with built-in load capacitance.

Part Numbering

(Ex.)

CS	T	LS	4M00	G	5	3		-A0
①	②	③	④	⑤	⑥	⑦	⑧	⑨

- ① Product ID
- ② Frequency/Built-in Capacitance
- ③ Structure/Size
LS: Round Lead Type
- ④ Nominal Center Frequency
- ⑤ Type
G: Thickness Shear vibration,
X: Thickness Longitudinal Vibration (3rd overtone)
- ⑥ Frequency Tolerance
1: ±0.1%, 2: ±0.2%, 3: ±0.3%, 5: ±0.5%, D: DTMF,
Z: Others
- ⑦ Built-in Load capacitance
1: 5pF, 3: 15pF, 4: 22pF, 5: 30pF, 6: 47pF
- ⑧ Individual Specification
With standard products, "⑧ Individual Specification" is omitted, and "⑨ Package Specification Code" is carried up.
- ⑨ Packaging
-B0: Bulk,
-A0: Radial Taping HO=18mm Ammo Pack (Standard)

Part Numbers and Dimensions of lead CERALOCK (CSTLS Series)

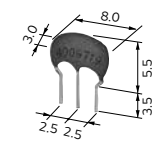
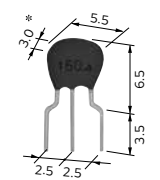
Part Number	Frequency	Dimensions (in mm)
CSTLS G	3.40–10.00MHz	
CSTLS X	16.00–70.00MHz	

* 16.00–32.99MHz : 3.5

MHz Band Chip CERALOCK (CSTCR/CSTNR/CSTNE Series)

The MHz band Chip CERALOCK has a wide frequency range and small footprint to meet further downsizing and high-density mounting requirements.

The table shows the dimensions and three-terminals standard land patterns of CSTCR/CSTNE series chip resonator (built-in load capacitance type.) The carrier tape dimensions of CSTCR series are shown on the next page.

Part Numbering

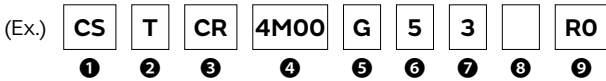

- ① Product ID
- ② Frequency/No capacitance built-in
T: Built-in Capacitance
- ③ Structure/Size
CR/NR/NE. Cap Chip Type
- ④ Nominal Center Frequency
- ⑤ Type
G: Thickness Shear Vibration,
V: Thickness Longitudinal Vibration,
- ⑥ Frequency Tolerance
1: ±0.1%, 2: ±0.2%, 3: ±0.3%, 5: ±0.5%, H: ±0.07%
- ⑦ Load Capacitance Value
1: 5pF or 6pF, 2 : 10pF, 3: 15pF, 5: 33pF or 39pF,
6: 47pF
- ⑧ Individual Specification
With standard products, "⑧ Individual Specification" is omitted, and "⑨ Package Specification Code" is carried up.
- ⑨ Packaging
B0: Bulk,
R0: Plastic Taping φ 180mm Reel Package

Dimensions and Standard Land Pattern of Chip CERALOCK (CSTCR/CSTNR/CSTNE Series)

Part Number	Frequency (MHz)	Dimensions Standard Land Pattern (in mm)
CSTCR G*1 CSTNR G*1	4.00–7.99	
CSTNE G*1	8.00–13.99	
CSTNE V*1	14.00–20.00	

* 1 Conformal coating or washing of the components is not acceptable because they are not hermetically sealed.

⚠️Note • Please read rating and ⚠️CAUTION (for storage, operating, rating, soldering, mounting and handling) in this catalog to prevent smoking and/or burning, etc.
 • This catalog has only typical specifications. Therefore, please approve our product specifications or transact the approval sheet for product specifications before ordering.

Dimensions of Carrier Tape for Chip CERALOCK

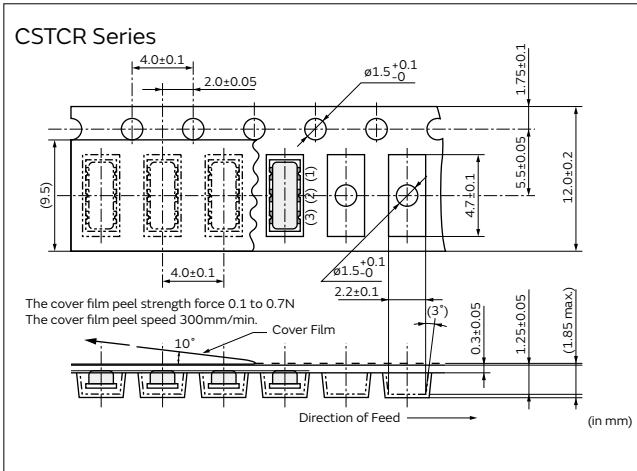

2 Principles of CERALOCK

2

1. Equivalent Circuit Constants

Fig. 2-1 shows the symbol for a ceramic resonator. The impedance and phase characteristics measured between the terminals are shown in Fig. 2-2. This illustrates that the resonator becomes inductive in the frequency zone between the frequency F_r (resonant frequency), which provides the minimum impedance, and the frequency F_a (anti-resonant frequency), which provides the maximum impedance.

It becomes capacitive in other frequency zones. This means that the mechanical vibration of a two-terminal resonator can be replaced equivalently with a combination of series and parallel resonant circuits consisting of an inductor : L, a capacitor : C, and a resistor : R. In the vicinity of the specific frequency (Refer to Note 1 on page 8), the equivalent circuit can be expressed as shown in Fig. 2-3.

F_r and F_a frequencies are determined by the piezoelectric ceramic material and the physical parameters. The equivalent circuit constants can be determined from the following formulas. (Refer to Note 2 on page 8)

$$F_r = 1/2\pi \sqrt{L_1 C_1} \quad (2-1)$$

$$F_a = 1/2\pi \sqrt{L_1 C_1 C_0 / (C_1 + C_0)} = F_r \sqrt{1 + C_1 / C_0} \quad (2-2)$$

$$Q_m = 1/2\pi F_r C_1 R_1 \quad (2-3)$$

(Q_m : Mechanical Q)

Considering the limited frequency range of $F_r \leq F \leq F_a$, the impedance is given as $Z = R_e + j\omega L_e$ ($L_e \geq 0$) as shown in Fig. 2-4, and CERALOCK should work as an inductance L_e (H) having the loss R_e (Ω).

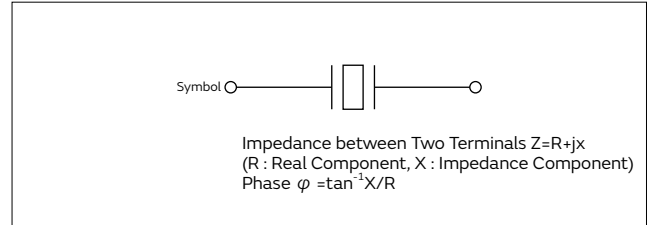

Fig. 2-1 Symbol for the Two-Terminal CERALOCK

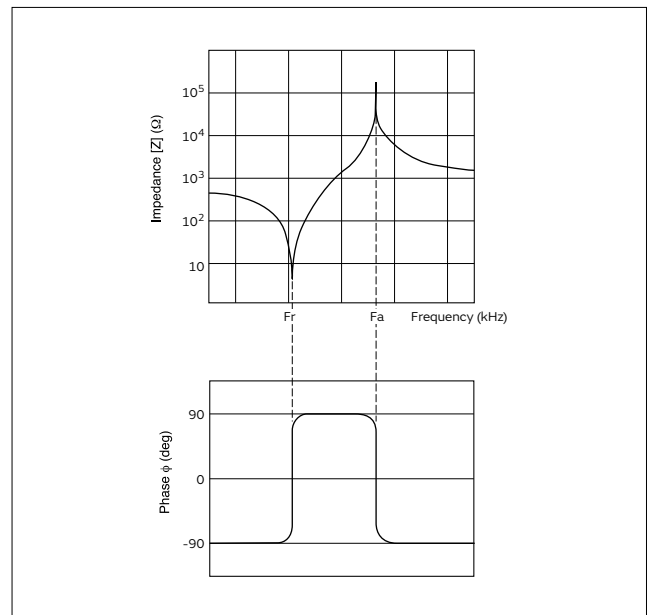

Fig. 2-2 Impedance and Phase Characteristics of CERALOCK

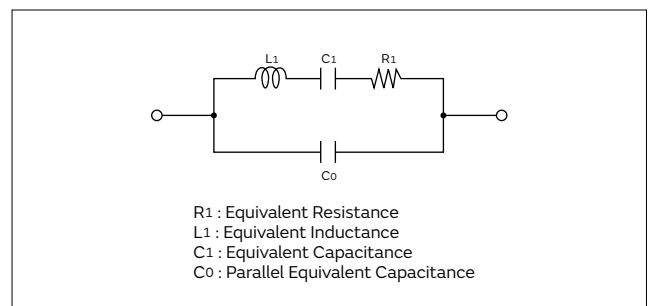

Fig. 2-3 Electrical Equivalent Circuit of CERALOCK

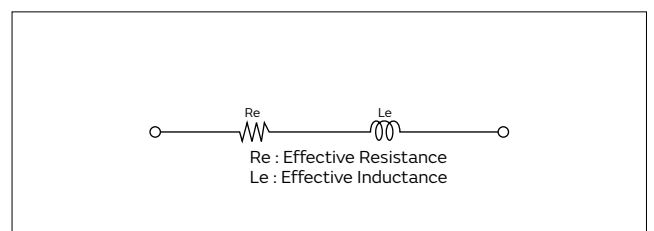

Fig. 2-4 Equivalent Circuit of CERALOCK in the Frequency Band $F_r \leq F \leq F_a$

The table on this page shows a comparison of the equivalent constants between CERALOCK and Crystal Units.

In comparison, there is a large difference in capacitance and Qm, which results in the difference of oscillating conditions, when actually operated.

The table in the appendix shows the standard values of an equivalent circuit constant for each type of CERALOCK. Furthermore, other higher harmonic modes exist, other than the desired oscillation mode. These other oscillation modes exist because the ceramic resonator uses mechanical resonance.

Fig. 2-5 shows those characteristics.

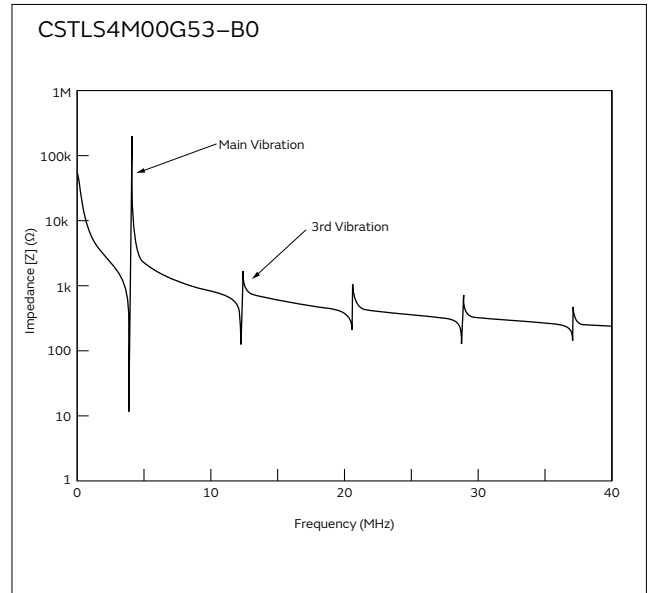

Fig. 2-5 Spurious Characteristics of CERALOCK

Comparison of Equivalent Circuits of CERALOCK and Crystal Unit (Reference)

Resonator	Oscillation Frequency	L ₁ (μH)	C ₁ (pF)	C ₀ (pF)	R ₁ (Ω)	Q _m	dF (kHz)
CERALOCK	4.00MHz	0.46 × 10 ³	3.8	19.8	9	1220	350.9
	8.00MHz	0.13 × 10 ³	3.5	19.9	8	775	641.6
Crystal Unit	4.00MHz	2.10 × 10 ⁵	0.007	2.39	22.1	240986	6
	8.00MHz	1.80 × 10 ⁵	0.002	4.48	154.7	59600	2

Notes

(Note 1)

The relationship between the size of the resonator and the resonant frequency is described as follows. For example, the frequency doubles if the thickness doubles, when thickness vibration is used.

The following relationship is obtained when the length of the resonators is ℓ , the resonance frequency is F_r , the speed of sound waves travelling through piezoelectric ceramics, and the wavelength is λ .

$$\begin{cases} F_r \cdot \ell = \text{Const.} \\ \text{(frequency constant, } F_r \cdot t \text{ for the thickness)} \\ \lambda = 2\ell \\ C = F_r \cdot \lambda = 2F_r \cdot \ell \end{cases}$$

As seen in the above formula, the frequency constant determines the size of the resonator.

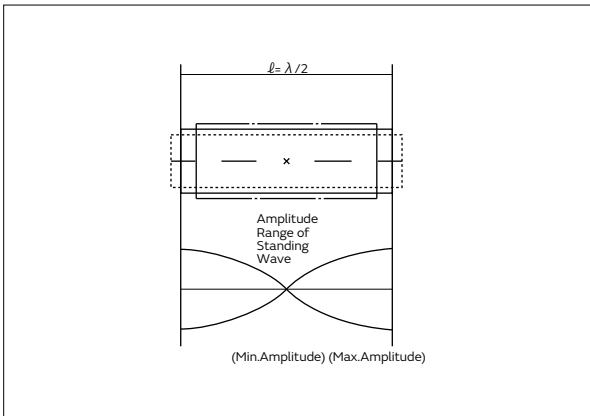

Fig. I

(Note 2)

In Fig. 2-3, when resistance R_1 is omitted for simplification, the impedance $Z(\omega)$ between two terminals is expressed by the following formula.

$$Z(\omega) = \frac{\frac{1}{j\omega C_0} (j\omega L_1 + \frac{1}{j\omega C_1})}{\frac{1}{j\omega C_0} + (j\omega L_1 + \frac{1}{j\omega C_1})} = \frac{j(\omega L_1 - \frac{1}{\omega C_1})}{1 + \frac{C_0}{C_1} - \omega^2 C_0 L_1}$$

When $\omega = \frac{1}{\sqrt{L_1 C_1}} = \omega_r$, $Z(\omega_r) = 0$

When $\omega = \frac{1}{\sqrt{C_0 C_1 L_1 / (C_0 + C_1)}} = \omega_a$, $Z(\omega_a) = \infty$

Therefore from $\omega = 2\pi F$,

$$F_r = \omega_r / 2\pi = \frac{1}{2\pi \sqrt{L_1 C_1}}$$

$$F_a = \omega_a / 2\pi = \frac{1}{2\pi \sqrt{C_0 C_1 L_1 / (C_0 + C_1)}} = F_r \sqrt{1 + \frac{C_1}{C_0}}$$

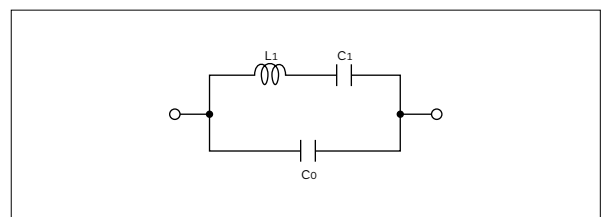

Fig. II

2. Basic Oscillation Circuits

Generally, basic oscillation circuits can be grouped into the following 3 categories.

- ① Use of positive feedback
- ② Use of negative resistance element
- ③ Use of delay in transfer time or phase

In the case of ceramic resonators, Crystal Units, and LC oscillators, positive feedback is the circuit of choice.

Among the positive feedback oscillation circuit using an LC, the tuning type anti-coupling oscillation circuit, Colpitts and Hartley circuits are typically used.

See Fig. 2-6.

In Fig. 2-6, a transistor, which is the most basic amplifier, is used.

The oscillation frequencies are approximately the same as the resonance frequency of the circuit consisting of L, C_{L1} and C_{L2} in the Colpitts circuit or consisting of L₁, L₂ and C in the Hartley circuit. These frequencies can be represented by the following formulas. (Refer to Note 3 on page 11.)

(Colpitts Circuit)

$$f_{osc} \doteq \frac{1}{2\pi \sqrt{L \cdot \frac{C_{L1} \cdot C_{L2}}{C_{L1} + C_{L2}}}} \quad (2-4)$$

(Hartley Circuit)

$$f_{osc} \doteq \frac{1}{2\pi \sqrt{C(L_1 + L_2)}} \quad (2-5)$$

In an LC network, the inductor is replaced by a ceramic resonator, taking advantage of the fact that the resonator becomes inductive between resonant and anti-resonant frequencies.

This is most commonly used in the Colpitts circuit.

The operating principle of these oscillation circuits can be seen in Fig. 2-7. Oscillation occurs when the following conditions are satisfied.

$$\left\{ \begin{array}{l} \text{Loop Gain } G = \alpha \cdot \beta \geq 1 \\ \text{Phase Amount} \\ \theta = \theta_1 + \theta_2 = 360^\circ \times n \quad (n = 1, 2, \dots) \end{array} \right. \quad (2-6)$$

In Colpitts circuit, an inverter of $\theta_1 = 180^\circ$ is used, and it is inverted more than $\theta_2 = 180^\circ$ with L and C in the feedback circuit. The operation with a ceramic resonator can be considered the same.

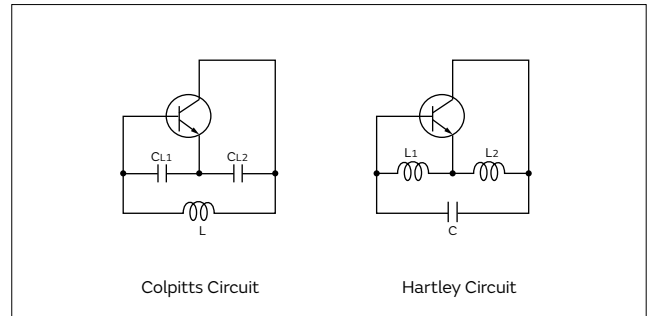

Fig. 2-6 Basic Configuration of LC Oscillation Circuit

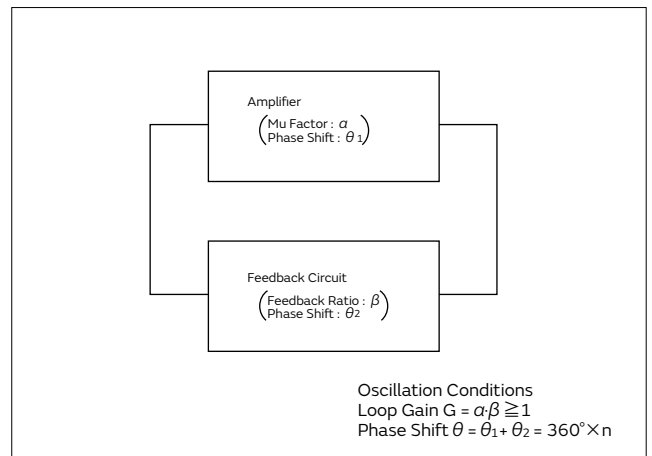

Fig. 2-7 Principle of Oscillation

2

It is common and simple to utilize an inverter for the Colpitts circuit with CERALOCK.

Fig. 2-8 shows the basic oscillation circuit with inverter.

In an open loop circuit by cutting at point (A), it is possible to measure loop gain G and phase shift θ .

Fig. 2-9 shows the actual measuring circuit, and an example of the measuring result is shown in Fig. 2-10.

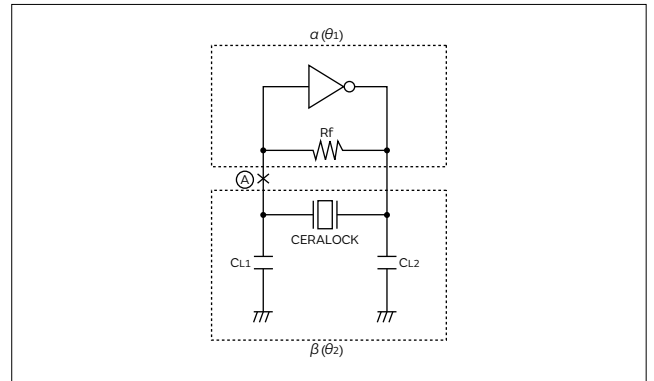

Fig. 2-8 Basic Oscillation Circuit with Inverters

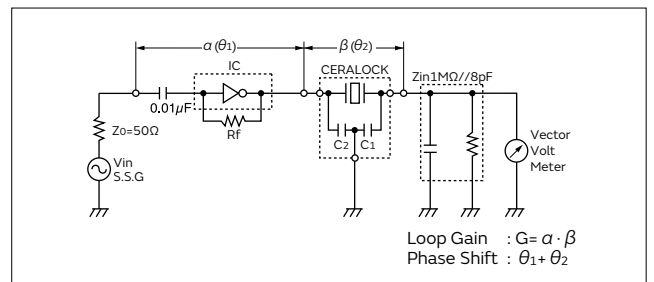

Fig. 2-9 Measuring Circuit Network of Loop Gain and Phase Shift

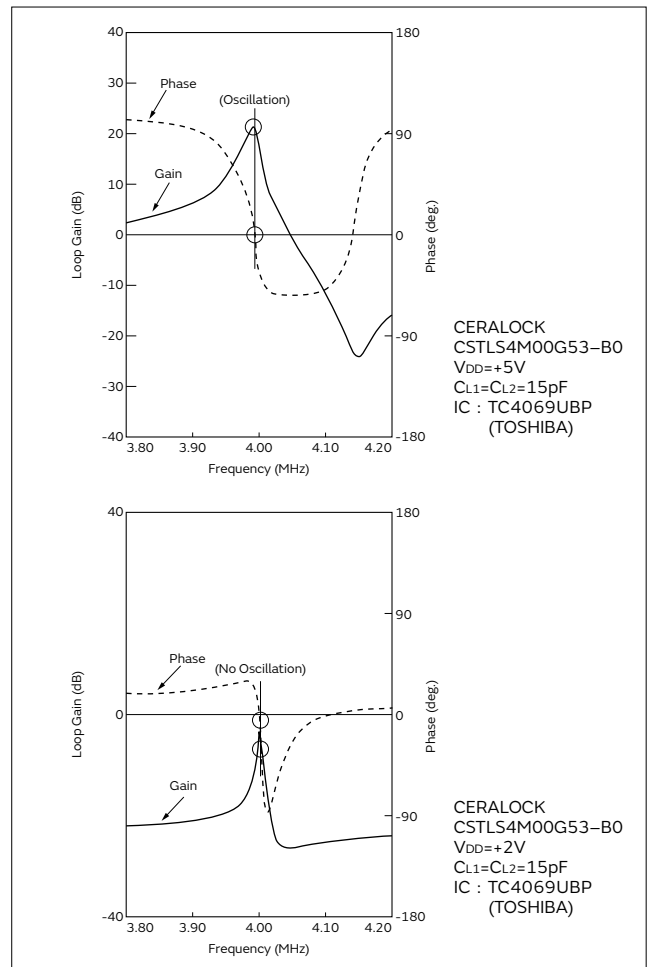

Fig. 2-10 Measured Results of Loop Gain and Phase Shift

Notes

(Note 3)

Fig.III shows the equivalent circuit of an emitter grounding type transistor circuit. In the figure, Ri stands for input impedance, RO stands for output impedance and β stands for current amplification rate.

When the oscillation circuit in Fig.2-6 is expressed by using the equivalent circuit in Fig.III, it becomes like Fig.IV. Z1, Z2 and Z are as shown in the table for each Hartley type and Colpitts type circuit.

The following 3 formulas are obtained based on Fig.IV.

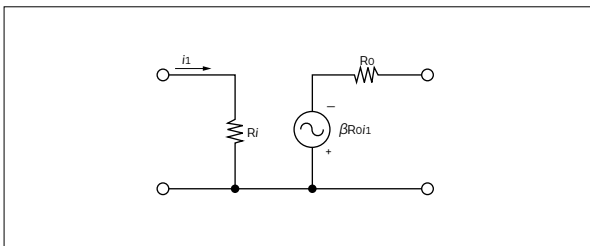

Fig. III

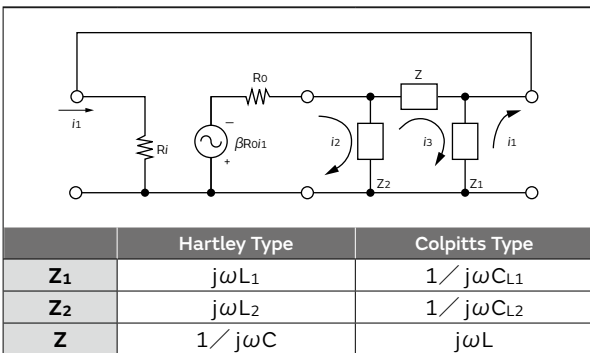

Fig.IV Hartley/Colpitts Type LC Oscillation Circuits

$$\begin{cases} \beta Ro i_1 + (Ro + Z_2) i_2 - Z_2 i_3 = 0 & \text{..... (1)} \\ Z_1 i_1 + Z_2 i_2 - (Z_2 + Z + Z_1) i_3 = 0 & \text{..... (2)} \\ (Z_1 + Ri) i_1 - Z_1 i_3 = 0 & \text{..... (3)} \end{cases}$$

As $i_1 \neq 0, i_2 \neq 0, i_3 \neq 0$ are required for continuous oscillation, the following conditional formula can be performed by solving the formulas of (1), (2) and (3) on the current.

$$\begin{cases} \beta Ro Z_1 Z_2 = (Z_1 + Ri) Z_2^2 - \{Z_1(Z_2 + Z) + (Z_2 + Z + Z_1) Ri\} (Z_2 + Ro) & \text{..... (4)} \end{cases}$$

Then, as Z1, Z2 and Z are all imaginary numbers, the following conditional formula is obtained by dividing the formula (4) into the real number part and the imaginary number part.

$$\begin{cases} \text{(Imaginary number part)} \\ Z_1 Z_2 Z + (Z_1 + Z_2 + Z) Ri Ro = 0 & \text{..... (5)} \\ \text{(Real number part)} \\ \beta Ro Z_1 Z_2 + Z_1 (Z + Z_2) Ro + Z_2 (Z + Z_1) Ri = 0 & \text{..... (6)} \end{cases}$$

Formula (5) represents the phase condition and formula (6) represents the power condition.

Oscillation frequency can be obtained by applying the elements shown in the aforementioned table to Z1, Z2 and Z solving it for angular frequency ω.

(Hartley Type)

$$\omega^2_{osc} = (2\pi f_{osc})^2 = \frac{1}{(L_1 L_2) C \left\{ 1 + \frac{L_1 \cdot L_2}{(L_1 + L_2) CRiRo} \right\}} \text{..... (7)}$$

(Colpitts Type)

$$\omega^2_{osc} = (2\pi f_{osc})^2 = \frac{1}{L} \cdot \frac{1}{\frac{C_{L1} \cdot C_{L2}}{C_{L1} + C_{L2}}} \cdot \left\{ 1 + \frac{L}{(C_{L1} + C_{L2}) RiRo} \right\} \text{..... (8)}$$

In either circuit, the term in brackets will be 1 as long as Ri and RO is large enough. Therefore oscillation frequency can be obtained by the following formula.

(Hartley Type) $f_{osc} \approx \frac{1}{2\pi \sqrt{(L_1 + L_2) C}} \text{..... (9)}$

(Colpitts Type) $f_{osc} \approx \frac{1}{2\pi \sqrt{L \cdot \frac{C_{L1} \cdot C_{L2}}{C_{L1} + C_{L2}}}} \text{..... (10)}$

3 Specifications of CERALOCK

RoHS

1. Electrical Specifications

The frequency stability of CERALOCK is between that of Crystal Units and LC or RC oscillators. Temperature stability is ± 0.3 to $\pm 0.5\%$ against initial values within -20 to $+80$ °C. The initial frequency precision is $\pm 0.5\%$ for standard products. The frequency of the standard CERALOCK is adjusted by the standard measuring circuit, but the oscillation frequency may shift when used in the actual IC circuit. Usually, if the frequency precision needed for clock signal of a 1 chip microcomputer is approximately ± 2 to 3% under working conditions, CERALOCK standard type can be used in most cases. If exact oscillation frequency is required for a special purpose, Murata can manufacture the ceramic resonator for the desired frequency.

The following are the general electrical specifications of CERALOCK. (As for the standard measuring circuit of oscillation frequency, please refer to the next chapter "Application to Typical Oscillation Circuits".)

Electrical Specifications of MHz Band Lead CERALOCK (CSTLS Series)

Electrical specifications of CSTLS series are shown in the tables. Please note that oscillation frequency measuring circuit constants of the CSTLS □G56 series (with H-CMOS IC) depends on frequency.

MHz band three-terminal CERALOCK (CSTLS Series) is built-in load capacitance.

Fig. 3-1 shows the electrical equivalent circuit.

The table shows the general specifications of the CSTLS series. Input and output terminals of the three-terminal CERALOCK are shown in the table titled Dimensions of CERALOCK CSTLS series in Chapter 1 on page 6.

But connecting reverse, the oscillating characteristics are not affected except that the frequency has a slight lag.

Resonant Impedance Specifications of CSTLS/ Series

Type	Frequency Range (MHz)	Resonant Impedance (Ω max.)
CSTLS□G	3.40 — 3.99	50
	4.00 — 7.99	30
	8.00 — 10.00	25
CSTLS□X	16.00 — 32.99	50
	33.00 — 50.00	40

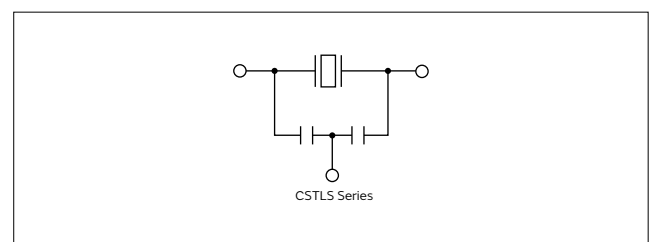

Fig. 3-1 Symbol for the Three-Terminal CERALOCK

⚠Note • Please read rating and ⚠CAUTION (for storage, operating, rating, soldering, mounting and handling) in this catalog to prevent smoking and/or burning, etc.
 • This catalog has only typical specifications. Therefore, please approve our product specifications or transact the approval sheet for product specifications before ordering.

General Specifications CSTLS Series

Part Number	Item	Frequency Range (MHz)	Initial Tolerance of Oscillation Frequency	Temperature Stability of Oscillation Frequency (-20 to +80°C)	Oscillating Frequency Aging	Standard Circuit for Oscillation Frequency
CSTLS□G53/56		3.40—10.00	±0.5%	±0.2%*1	±0.2%	<p>IC : TC4069UBP*3 V_{DD} : +5V X : CERALOCK R_d : 680Ω*4</p>
CSTLS□X		16.00—50.00	±0.5%	±0.2%	±0.2%	

- * 1 This value varies for built-in Capacitance
- * 2 If connected conversely, a slight frequency lag may occur.
- * 3 G56/X series : TC74HCU04(TOSHIBA)
- * 4 This resistance value applies to the CSTLS□G56 series.

3

Electrical Specifications of MHz Band Chip CERALOCK (CSTCR/CSTNR/CSTNE Series)

General specifications of chip CERALOCK (CSTCR/CSTNR/CSTNE series) is shown in the tables respectively.

3

Resonant Impedance of CSTCR/CSTNR/CSTNE Series

Type	Frequency Range (MHz)	Resonant Impedance (Ω max.)
CSTCR□G CSTNR□G*1	4.00~5.99	60
	6.00~7.99	50
CSTNE□G	8.00~10.00	40
	10.01~13.990	30
CSTNE□V	14.00~20.000	40

General Specifications of CSTCR/CSTNE Series

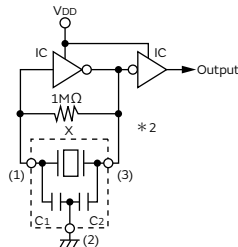
Part Number	Item	Frequency Range (MHz)	Initial Tolerance of Oscillation Frequency	Temperature Stability of Oscillation Frequency (-20 to +80°C)	Oscillating Frequency Aging	Standard Circuit for Oscillation Frequency
CSTCR□G (CSTNR□G)*1		4.00—7.99	$\pm 0.5\%$ ($\pm 0.07\%$)*1	$\pm 0.2\%$	$\pm 0.1\%$	 <p>IC: TC4069UBP*3 (TOSHIBA) V_{DD}: +5V X: Chip CERALOCK</p>
CSTNE□G		8.00—13.99	$\pm 0.5\%$	$\pm 0.2\%$	$\pm 0.1\%$	
CSTNE□V		14.00—20.00	$\pm 0.5\%$	$\pm 0.3\%$	$\pm 0.3\%$	

* 1 The series is used for only Tight Frequency tolerance.

* 2 If connected in the wrong direction, the above specification may not be guaranteed.

* 3 V Series; TC74HCU04(TOSHIBA).

2. Mechanical and Environmental Specifications of CERALOCK

The tables show the standard test conditions of mechanical strength and environmental specifications of CERALOCK.

Fig. 3-2 shows the changes of oscillation frequency in each test, the table on the next page shows the criteria after the tests, and Fig. 3-3 shows the reflow soldering profile.

Test Conditions for Standard Reliability of CERALOCK

Item	Conditions
1. Shock Resistance	Measure after dropping from a height of [a] cm to [b] floor surface 3 times.
2. Soldering Heat Resistance	Lead terminals are immersed up to 2.0 mm from the resonator's body in solder bath of [c], and then the resonator shall be measured after being placed in natural condition for 1 hour.* ¹ Reflow profile show in Fig. 3-3 of heat stress is applied to the resonator, then the resonator shall be measured after being placed in natural condition for 1 hour.* ²
3. Vibration Resistance	Measure after applying vibration of 10 to 55Hz amplitude of 2 mm to each of 3 directions, X, Y, Z.
4. Humidity Resistance	Keep in a chamber with a temperature of [d] and humidity of 90 to 95% for [e] hours. Leave for 1 hour before measurement.
5. Storage at High Temperature	Keep in a chamber at 85±2°C for [e] hours. Leave for 1 hour before measurement.
6. Storage at Low Temperature	Keep in a chamber at [f] °C for [e] hours. Leave for 1 hour before measurement.
7. Temperature Cycling	Keep in a chamber at -55°C for 30 minutes. After leaving at room temperature for 15 minutes, keep in a chamber at +85°C for 30 minutes, and then room temperature for 15 minutes. After 10 cycles of the above, measure at room temperature.
8. Terminal Strength	Apply 1 kg of static load vertically to each terminal and measure.* ¹

* 1 Applies to CERALOCK Lead Type

* 2 Applies to MHz Band Chip CERALOCK

1. CSTLS Series

Type	fosc.	a	b	c	d	e	f
G	3.40—10.00MHz	100	concrete	350±10°C	60±2°C	1000	-55±2°C
X	16.00—50.00MHz	100	concrete	350±10°C	60±2°C	1000	-55±2°C

2. CSTCR/CSTNR/CSTNE Series

Type	fosc.	a	b	c	d	e	f
G	4.00—13.99MHz	100	wooden plate	—	60±2°C	1000	-55±2°C
V	14.00—20.00MHz	100	wooden plate	—	60±2°C	1000	-55±2°C

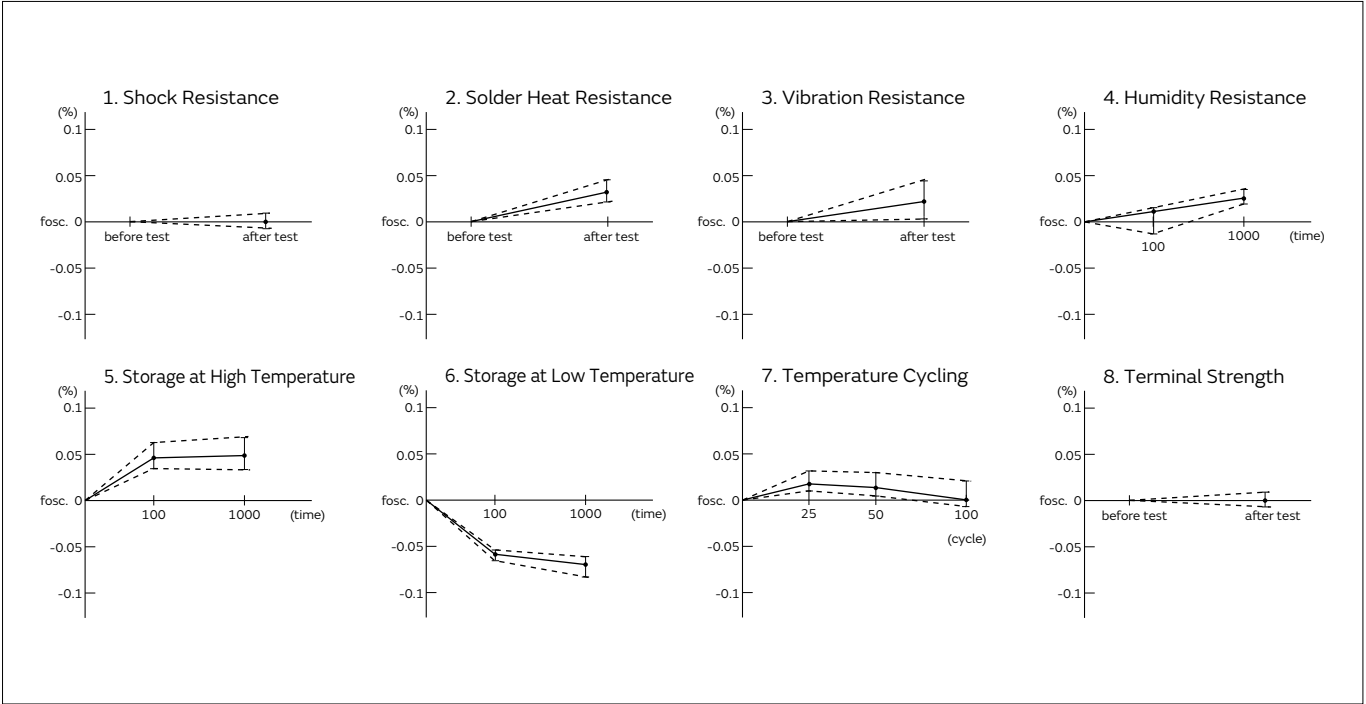

Fig. 3-2 General Changes of Oscillation Frequency in Each Reliability Test (CSTLS4M00G53-B0)

Deviation after Reliability Test

Type	Item	Oscillation Frequency	Other
Every Series		within $\pm 0.2\%$ (from initial value)	Meets the individual specification of each product.

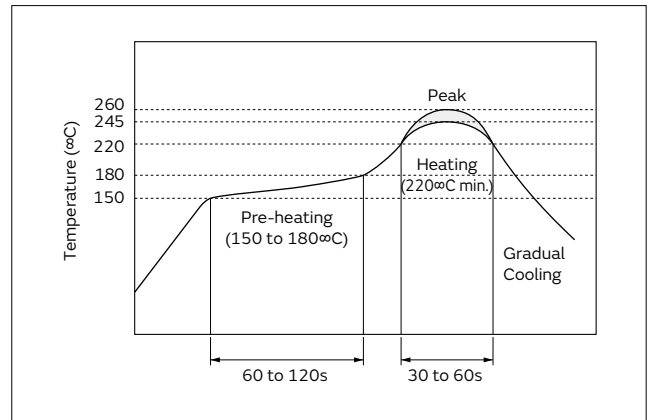

Fig. 3-3 Reflow Soldering Profile for MHz Band Chip CERALOCK

4 Applications of Typical Oscillation Circuits RoHS

As described in Chapter 2, the most common oscillation circuit with CERALOCK is to replace L of a Colpitts circuit with CERALOCK. The design of the circuit varies with the application and the IC being used, etc. Although the basic configuration of the circuit is the same as that of Crystal Units, the difference in mechanical Q results in the difference of the circuit constant.

This chapter briefly describes the characteristics of the oscillation circuit and gives some typical examples.

1. Cautions for Designing Oscillation Circuits

It is becoming more common to configure the oscillation circuit with a digital IC, and the simplest way is to use an inverter gate.

Fig. 4-1 shows the configuration of a basic oscillation circuit with a C-MOS inverter.

INV. 1 works as an inverter amplifier of the oscillation circuit. INV. 2 acts to shape the waveform and also acts as a buffer for the connection of a frequency counter.

The feedback resistance R_f provides negative feedback around the inverter in order to put it in the linear region, so the oscillation will start, when power is applied.

If the value of R_f is too large, and if the insulation resistance of the input inverter is accidentally decreased, oscillation will stop due to the loss of loop gain. Also, if R_f is too great, noise from other circuits can be introduced into the oscillation circuit.

Obviously, if R_f is too small, loop gain will be low. An R_f of $1M\ \Omega$ is generally used with a ceramic resonator.

Damping resistor R_d provides loose coupling between the inverter and the feedback circuit and decreases the loading on the inverter, thus saving energy.

In addition, the damping resistor stabilizes the phase of the feedback circuit and provides a means of reducing the gain in the high frequency area, thus preventing the possibility of spurious oscillation.

Load capacitance C_{L1} and C_{L2} provide the phase lag of 180° . The proper selected value depends on the application, the IC used, and the frequency.

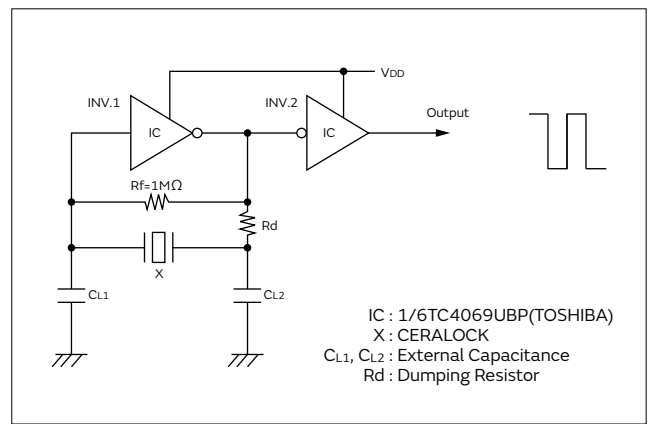

Fig. 4-1 Basic Oscillation Circuit with C-MOS Inverter

4

Oscillation frequency $f_{osc.}$ in this circuit is expressed approximately by the following equation.

$$f_{osc.} = Fr \sqrt{1 + \frac{C_1}{C_0 + C_L}} \quad (4-1)$$

Where, Fr = Resonance frequency of CERALOCK

C_1 : Equivalent series capacitance of CERALOCK

C_0 : Equivalent parallel capacitance of CERALOCK

$$C_L = \frac{C_{L1} \cdot C_{L2}}{C_{L1} + C_{L2}}$$

This clearly shows that the oscillation frequency is influenced by the loading capacitance. Further caution should be paid in defining its value when a tight tolerance of oscillation frequency is required.

4

2. Application to Various Oscillation Circuits

Application to C-MOS Inverter

For the C-MOS inverting amplifier, the one-stage 4069 C-MOS group is best suited.

The C-MOS 4049 type is not used, because the three-stage buffer type has excessive gain, which causes RC oscillation and ringing.

Murata employs the TOSHIBA TC4069UBP as a C-MOS standard circuit. This circuit is shown in

Fig. 4-2. The oscillation frequency of the standard CERALOCK (C-MOS specifications) is adjusted by the circuit in Fig. 4-2.

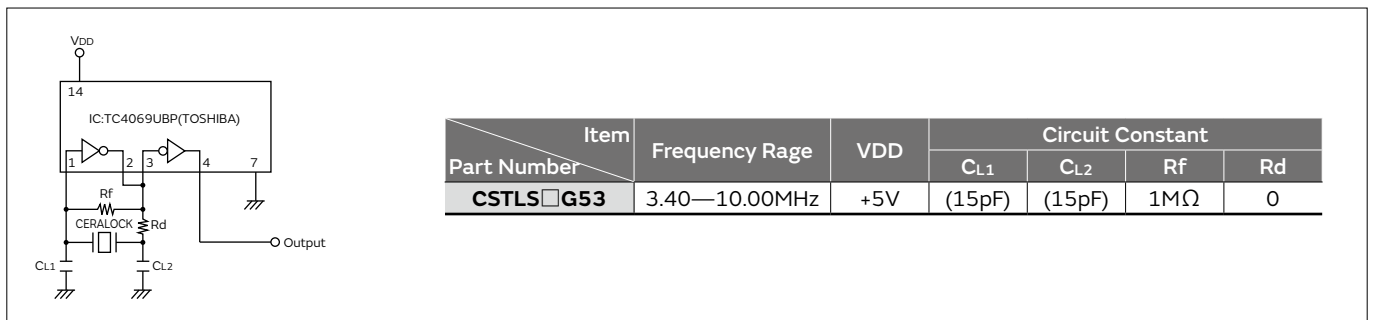

Fig. 4-2 C-MOS Standard Circuit

Application to H-CMOS Inverter

Recently, high-speed C-MOS (H-CMOS) have been used more frequently for oscillation circuits allowing high speed and energy saving control for the microprocessor.

There are two types of H-CMOS inverters: the un- buffered 74HCU series and the 74HC series with buffers.

The 74HCU system is optimum for the CERALOCK oscillation circuit.

Fig. 4-3 shows our standard H-CMOS circuit.

Since H-CMOS has high gain, especially in the high frequency area, greater loading capacitor (CL) and damping resistor (Rd) should be employed to stabilize oscillation performance. As a standard circuit, we recommend Toshiba's TC74CU04, but any 74HCU04 inverter from other manufacturers may be used.

The oscillation frequency for H-CMOS specifications is adjusted by the circuit in Fig. 4-3.

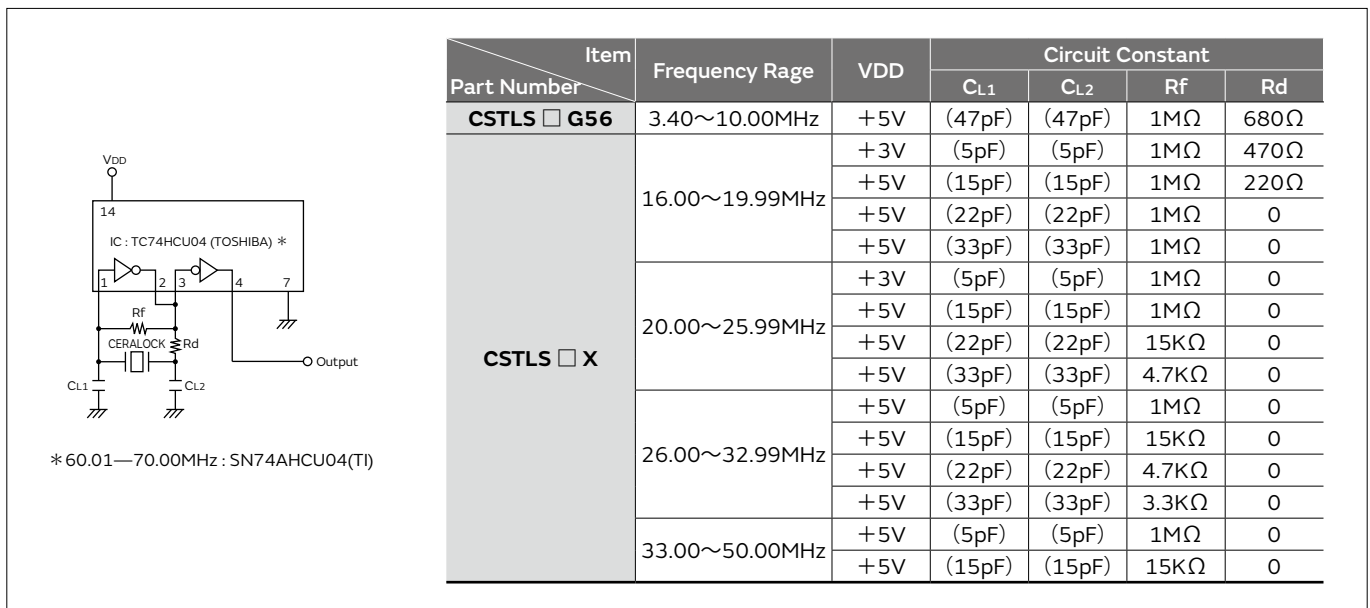

Fig. 4-3 H-CMOS Standard Circuit



5 Characteristics of CERALOCK Oscillation Circuits



This chapter describes the general characteristics of the basic oscillation of Fig. 4-1 (page17). Contact Murata for detailed characteristics of oscillation with specific kinds of ICs and LSIs.

1. Stability of Oscillation Frequency

Fig. 5-1 shows examples of actual measurements for stability of the oscillation frequency.

The stability versus temperature change is ± 0.1 to 0.5% within a range of -20 to $+80^\circ\text{C}$, although it varies slightly depending on the ceramic material.

Influence of load capacitance (C_{L1} , C_{L2}) on the oscillation frequency is relatively high, as seen in formula (4-1) (Page18).

It varies approximately $\pm 0.05\%$ for a capacitance deviation of $\pm 10\%$. The stability versus supply voltage is normally within $\pm 0.05\%$ in the working voltage range, although it varies with the characteristics of the IC.

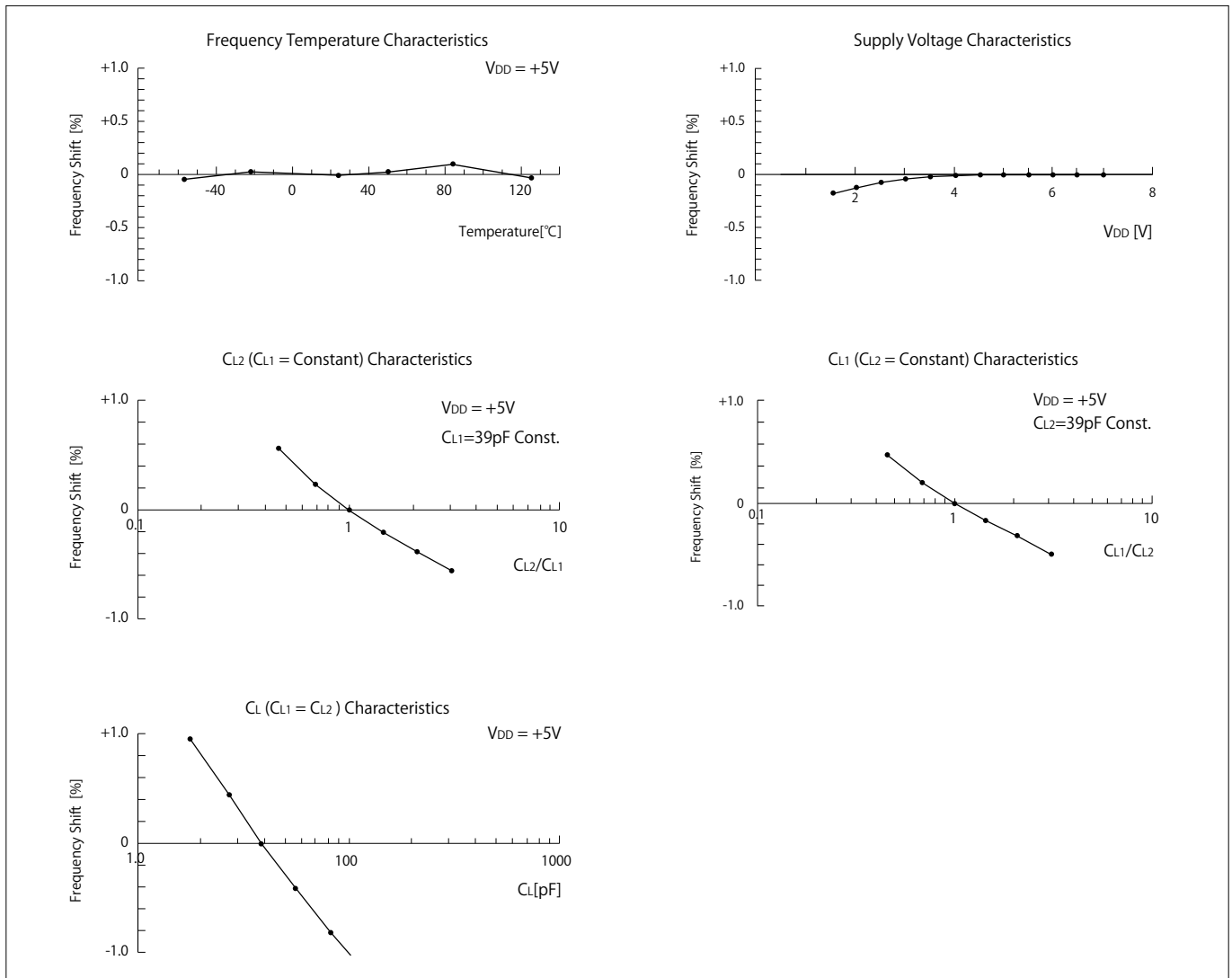

Fig. 5-1 Examples of Actual Measurement for the Stability of Oscillation Frequency (IC: TC74HCU04 (TOSHIBA), CERALOCK: CSTCR4M00G55-R0)

2. Characteristics of the Oscillation Level

Fig. 5-2 shows examples of actual measurements of the oscillation level versus temperature, supply voltage and load capacitance (C_{L1} , C_{L2}). The oscillating amplitude is required to be stable over a wide temperature range, and temperature characteristics should be as flat as possible. The graph titled Supply Voltage Characteristics in Fig. 5-2 shows that the amplitude varies linearly with supply voltage, unless the IC has an internal power supply voltage regulator.

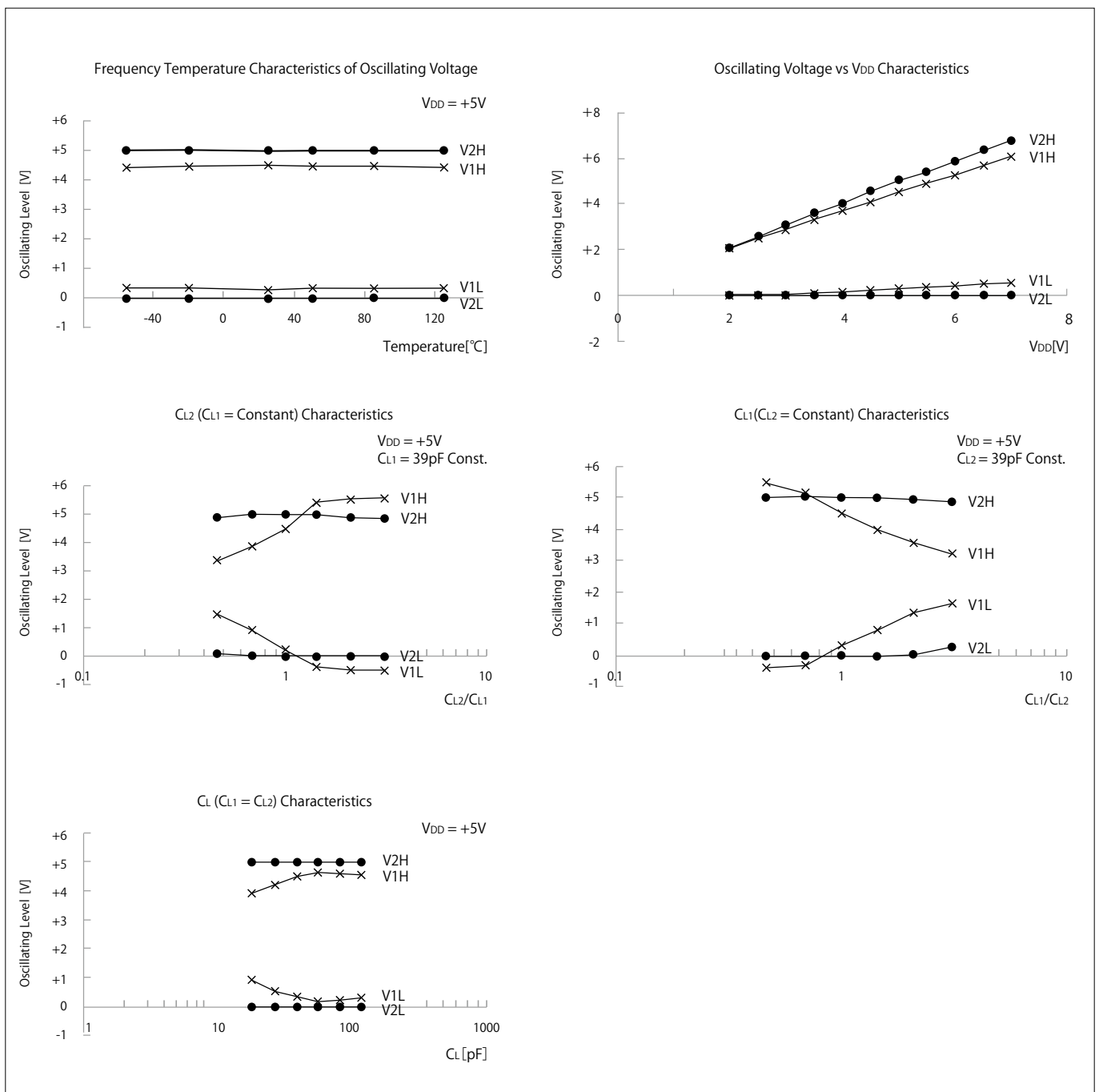

Fig. 5-2 Examples of Actual Measurement of Oscillating Amplitude (IC: TC74HCU04(TOSHIBA), CERALOCK: CSTCR4M00G55-R0)

3. Characteristics of Oscillation Rise Time

Oscillation rise time means the time when oscillation develops from a transient area to a steady state condition, at the time the power of the IC is activated.

With a CERALOCK, this is defined as the time to reach 90% of the oscillation level under steady state conditions as shown in Fig. 5-3.

Rise time is primarily a function of the oscillation circuit design. Generally, smaller loading capacitance, higher frequency of ceramic resonator, and lower mechanical Q of ceramic resonator cause a faster rise time. The effect of load capacitance becomes more apparent as the capacitance of the resonator decreases.

Fig. 5-4 shows how the rise time increases as the load capacitance of the resonator increases. Also, Fig. 5-4 shows how the rise time varies with supply voltage.

It is noteworthy that the rise time of CERALOCK is one or two decades faster than a Crystal Unit.

Fig. 5-5 shows comparison of rise time between the two.

5

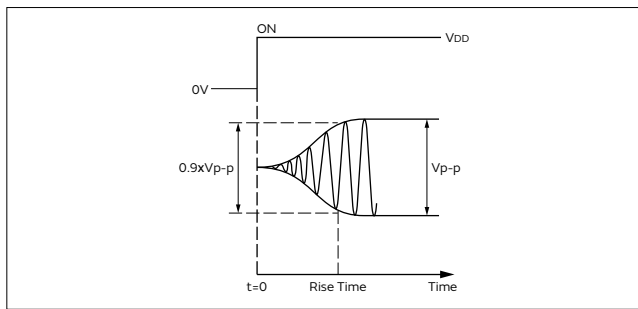

Fig. 5-3 Definition of Rise Time

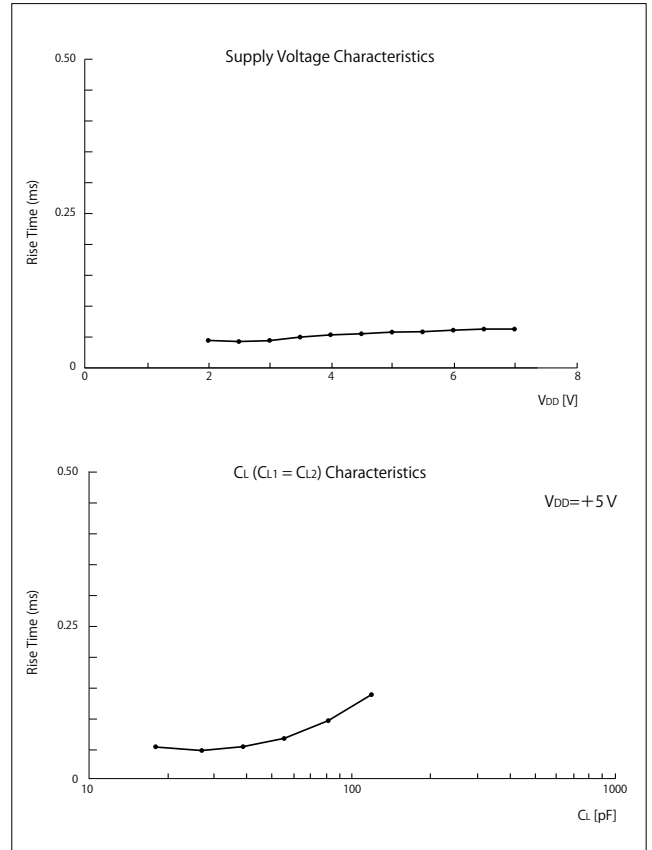

Fig. 5-4 Examples of Characteristics of Oscillation Rise Time (IC: TC74HCU04 (TOSHIBA), CERALOCK: CSTCR4M00G55-R0)

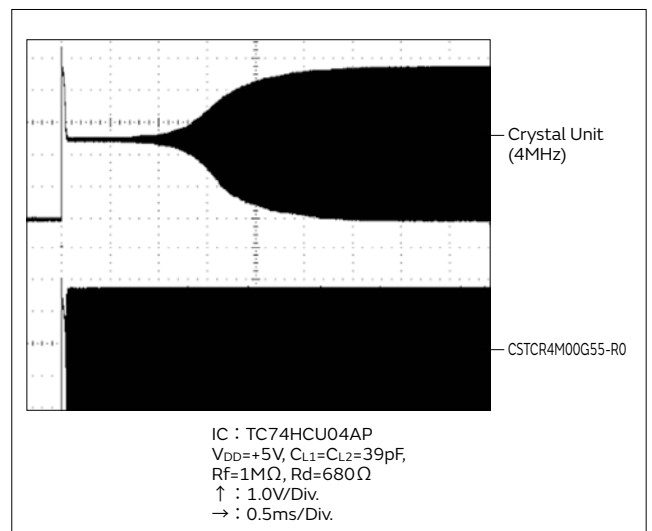

Fig. 5-5 Comparison of the Rise Time of CERALOCK vs. a Crystal Unit

4. Starting Voltage

Starting voltage refer to the minimum supply voltage at which an oscillation circuit can operate. Starting voltage is affected by all the circuit elements, but it is determined mostly by the characteristics of the IC.

Fig. 5-6 shows an example of an actual measurement for the starting voltage characteristics against the loading capacitance.

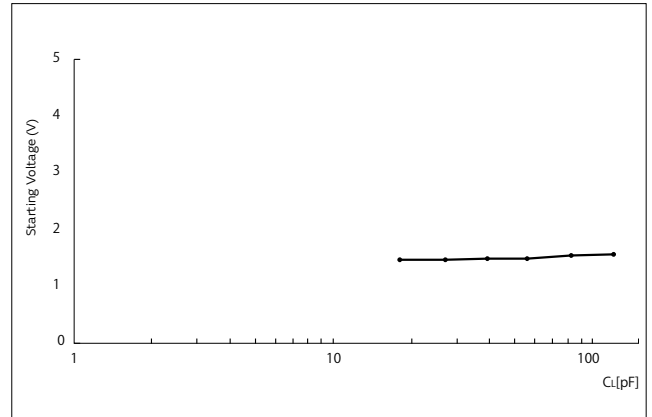

Fig. 5-6 Starting Voltage Characteristics against CL
($C_{L1}=C_{L2}$)
(IC: TC74HCU04 (TOSHIBA), CERALOCK:
CSTCR4M00G55-R0)

6 Application Circuits to Various ICs/LSIs

RoHS

CERALOCK, by making good use of the above-mentioned features, is used in a wide range of applications to various kinds of ICs.

The following are a few examples of actual applications.

1. Application to Microcomputers

CERALOCK is optimum for a stable oscillation element for various kinds of microcomputers : 4-bit, 8-bit, 16-bit and 32-bit.

With the general frequency tolerance required for the reference clock of microcomputers at ± 2 to $\pm 3\%$, standard CERALOCK meets this requirement. Please consult with MURATA or IC manufacturers about the circuit constants, because these constants vary with frequency and the IC circuit being used.

Murata is checking an oscillation circuit condition with various microcomputers and CERALOCK. The table shows Murata recommendation circuit condition with a part of ICs which Murata tested.

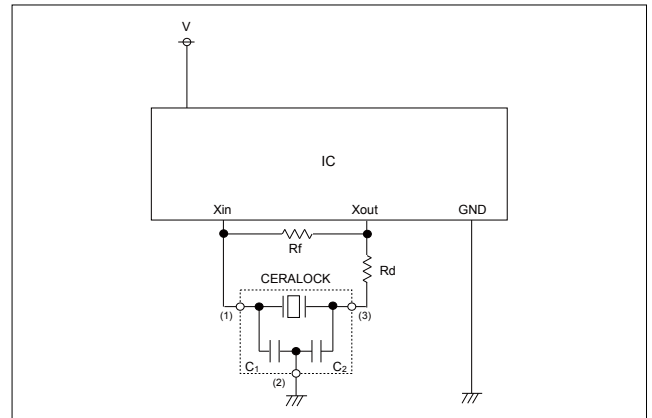

Feg6. Representative circuit diagram

Another recommended circuit condition of many ICs has been uploaded to Murata Web site. Please access to the below URL.

<http://www.murata.com/simsurf/ic-td/>

Recommendable circuit constants examples of representative microcomputers

IC Part Number	IC Manufacturer	Part Number	Osc. Freq. (MHz)	C1 (pF)	C2 (pF)	Rf (ohm)	Rd (ohm)	IC vol. (V min.)	IC vol. (V max.)	Application	Type
RL78/G13 (LV,AMPH=0)	Renesas Electronics	CSTCR4M00G55-R0	4.00	39	39	open	0	1.6	5.5	Consumer	SMD
RL78/G13 (LV,AMPH=0)	Renesas Electronics	CSTLS4M00G53-B0	4.00	15	15	open	0	1.6	5.5	Consumer	Lead
RL78/G13 (LS,AMPH=0)	Renesas Electronics	CSTNE8M00G550000R0	8.00	33	33	open	0	1.8	5.5	Consumer	SMD
RL78/G13 (LS,AMPH=0)	Renesas Electronics	CSTLS8M00G53-B0	8.00	15	15	open	0	1.8	5.5	Consumer	Lead
RL78/G13 (HS,AMPH=1)	Renesas Electronics	CSTNE12M0G550000R0	12.00	33	33	open	0	1.8	5.5	Consumer	SMD
RL78/G13 (HS,AMPH=1)	Renesas Electronics	CSTNE16M0V530000R0	16.00	15	15	open	0	2.4	5.5	Consumer	SMD
RL78/G13 (HS,AMPH=1)	Renesas Electronics	CSTNE20M0V510000R0	20.00	5	5	open	0	2.7	5.5	Consumer	SMD
RX210	Renesas Electronics	CSTCR4M00G55-R0	4.00	39	39	open	0	1.62	5.5	Consumer	SMD
RX210	Renesas Electronics	CSTLS4M00G56-B0	4.00	47	47	open	0	1.62	5.5	Consumer	Lead
RX210	Renesas Electronics	CSTNE8M00G550000R0	8.00	33	33	open	0	1.62	5.5	Consumer	SMD
RX210	Renesas Electronics	CSTLS8M00G56-B0	8.00	47	47	open	0	1.62	5.5	Consumer	Lead
RX210	Renesas Electronics	CSTNE16M0V530000R0	16.00	15	15	open	0	1.62	5.5	Consumer	SMD
RX210	Renesas Electronics	CSTNE20M0V530000R0	20.00	15	15	open	0	1.62	5.5	Consumer	SMD
S6J342A (amplifier=on)	Cypress	CSTCR4M00G55B-R0	4.00	39	39	open	1.5k	2.7	5.5	Automotive	SMD
S6J342A (amplifier=on)	Cypress	CSTNR4M00GH5C000R0	4.00	39	39	open	1.5k	2.7	5.5	Automotive	SMD
S6J342A (amplifier=on)	Cypress	CSTNE8M00G55A000R0	8.00	33	33	open	680	2.7	5.5	Automotive	SMD
S6J342A (amplifier=on)	Cypress	CSTNE8M00GH5C000R0	8.00	33	33	open	680	2.7	5.5	Automotive	SMD
S6J342A (amplifier=on)	Cypress	CSTNE16M0V53C000R0	16.00	15	15	open	330	2.7	5.5	Automotive	SMD
S6J342A (amplifier=on)	Cypress	CSTNE16M0VH3C000R0	16.00	15	15	open	330	2.7	5.5	Automotive	SMD
STM32F1xx	STMicroelectronics	CSTCR4M00G55-R0	4.00	39	39	open	0	2.0	3.6	Consumer	SMD
STM32F1xx	STMicroelectronics	CSTNR4M00GH5L000R0	4.00	39	39	open	0	2.0	3.6	Consumer	SMD
STM32F1xx	STMicroelectronics	CSTCR4M00G55B-R0	4.00	39	39	open	0	2.0	3.6	Automotive	SMD
STM32F1xx	STMicroelectronics	CSTNR4M00GH5C000R0	4.00	39	39	open	0	2.0	3.6	Automotive	SMD
STM32F1xx	STMicroelectronics	CSTNE8M00G550000R0	8.00	33	33	open	0	2.0	3.6	Consumer	SMD
STM32F1xx	STMicroelectronics	CSTNE8M00GH5L000R0	8.00	33	33	open	0	2.0	3.6	Consumer	SMD
STM32F1xx	STMicroelectronics	CSTNE8M00G55A000R0	8.00	33	33	open	0	2.0	3.6	Automotive	SMD
STM32F1xx	STMicroelectronics	CSTNE8M00GH5C000R0	8.00	33	33	open	0	2.0	3.6	Automotive	SMD
STM32F1xx	STMicroelectronics	CSTNE16M0V530000R0	16.00	15	15	open	0	2.0	3.6	Consumer	SMD
STM32F1xx	STMicroelectronics	CSTNE16M0VH3L000R0	16.00	15	15	open	0	2.0	3.6	Consumer	SMD
STM32F1xx	STMicroelectronics	CSTNE16M0V53C000R0	16.00	15	15	open	0	2.0	3.6	Automotive	SMD
STM32F1xx	STMicroelectronics	CSTNE16M0VH3C000R0	16.00	15	15	open	0	2.0	3.6	Automotive	SMD
STM32F1xx	STMicroelectronics	CSTNE20M0V530000R0	20.00	15	15	open	0	2.0	3.6	Consumer	SMD
STM32F1xx	STMicroelectronics	CSTNE20M0VH3L000R0	20.00	15	15	open	0	2.0	3.6	Consumer	SMD
STM32F1xx	STMicroelectronics	CSTNE20M0V53C000R0	20.00	15	15	open	0	2.0	3.6	Automotive	SMD
STM32F1xx	STMicroelectronics	CSTNE20M0VH3C000R0	20.00	15	15	open	0	2.0	3.6	Automotive	SMD
PIC16F1824 (HS)	Microchip	CSTCR4M00G53-R0	4.00	15	15	1M	0	2.0	5.5	Consumer	SMD
PIC16F1824 (HS)	Microchip	CSTLS4M00G53-B0	4.00	15	15	1M	0	2.0	5.5	Consumer	Lead
PIC16F1824 (HS)	Microchip	CSTNE8M00G520000R0	8.00	10	10	1M	330	2.0	5.5	Consumer	SMD
PIC16F1824 (HS)	Microchip	CSTLS8M00G53-B0	8.00	15	15	1M	330	2.0	5.5	Consumer	Lead
PIC16F1824 (HS)	Microchip	CSTNE16M0V510000R0	16.00	5	5	1M	0	2.0	5.5	Consumer	SMD
PIC16F1824 (HS)	Microchip	CSTNE20M0V510000R0	20.00	5	5	1M	0	2.0	5.5	Consumer	SMD

Recommendable circuit constants examples of representative microcomputers

IC Part Number	IC Manufacturer	Part Number	Osc. Freq. (MHz)	C1 (pF)	C2 (pF)	Rf (ohm)	Rd (ohm)	IC vol. (V min.)	IC vol. (V max.)	Application	Type
MPC5634M	NXP Semiconductors	CSTCR4M00G55B-R0	4.00	39	39	open	470	4.5	5.25	Automotive	SMD
MPC5634M	NXP Semiconductors	CSTNR4M00GH5C000R0	4.00	39	39	open	470	4.5	5.25	Automotive	SMD
MPC5634M	NXP Semiconductors	CSTNE8M00G55A000R0	8.00	33	33	open	0	4.5	5.25	Automotive	SMD
MPC5634M	NXP Semiconductors	CSTNE8M00GH5C000R0	8.00	33	33	open	0	4.5	5.25	Automotive	SMD
MPC5634M	NXP Semiconductors	CSTNE16M0V53C000R0	16.00	15	15	open	0	4.5	5.25	Automotive	SMD
MPC5634M	NXP Semiconductors	CSTNE16M0VH3C000R0	16.00	15	15	open	0	4.5	5.25	Automotive	SMD
MPC5634M	NXP Semiconductors	CSTNE20M0V53C000R0	20.00	15	15	open	0	4.5	5.25	Automotive	SMD
MPC5634M	NXP Semiconductors	CSTNE20M0VH3C000R0	20.00	15	15	open	0	4.5	5.25	Automotive	SMD
TMPM46x	TOSHIBA	CSTNE8M00G550000R0	8.00	33	33	open	0	2.7	3.6	Consumer	SMD
TMPM46x	TOSHIBA	CSTNE10M0G550000R0	10.00	33	33	open	0	2.7	3.6	Consumer	SMD
TMPM46x	TOSHIBA	CSTNE12M0G550000R0	12.00	33	33	open	0	2.7	3.6	Consumer	SMD
TMPM46x	TOSHIBA	CSTNE16M0V530000R0	16.00	15	15	open	0	2.7	3.6	Consumer	SMD
TC27xT (GAINSEL=11b, APREN=0,CAPxEN=0)	Infineon	CSTNE8M00G55A000R0	8.00	33	33	open	330	2.97	5.5	Automotive	SMD
TC27xT (GAINSEL=11b, APREN=0,CAPxEN=0)	Infineon	CSTNE8M00GH5C000R0	8.00	33	33	open	330	2.97	5.5	Automotive	SMD
TC27xT (GAINSEL=11b, APREN=0,CAPxEN=0)	Infineon	CSTNE16M0V53C000R0	16.00	15	15	open	220	2.97	5.5	Automotive	SMD
TC27xT (GAINSEL=11b, APREN=0,CAPxEN=0)	Infineon	CSTNE16M0VH3C000R0	16.00	15	15	open	220	2.97	5.5	Automotive	SMD
TC27xT (GAINSEL=11b, APREN=0,CAPxEN=0)	Infineon	CSTNE20M0V53C000R0	20.00	15	15	open	150	2.97	5.5	Automotive	SMD
TC27xT (GAINSEL=11b, APREN=0,CAPxEN=0)	Infineon	CSTNE20M0VH3C000R0	20.00	15	15	open	150	2.97	5.5	Automotive	SMD
MSP430x5xx (TX2:TX2DRIVE=00)	Texas Instruments	CSTCR4M00G55-R0	4.00	39	39	open	0	2.0	3.6	Consumer	SMD
MSP430x5xx (TX2:TX2DRIVE=00)	Texas Instruments	CSTNR4M00GH5L000R0	4.00	39	39	open	0	2.0	3.6	Consumer	SMD
MSP430x5xx (TX2:TX2DRIVE=00)	Texas Instruments	CSTNE8M00G550000R0	8.00	33	33	open	0	2.0	3.6	Consumer	SMD
MSP430x5xx (TX2:TX2DRIVE=00)	Texas Instruments	CSTNE8M00GH5L000R0	8.00	33	33	open	0	2.0	3.6	Consumer	SMD
MSP430x5xx (TX2:TX2DRIVE=00)	Texas Instruments	CSTNE12M0G550000R0	12.00	33	33	open	0	2.0	3.6	Consumer	SMD
MSP430x5xx (TX2:TX2DRIVE=00)	Texas Instruments	CSTNE12M0GH5L000R0	12.00	33	33	open	0	2.0	3.6	Consumer	SMD
MSP430x5xx (TX2:TX2DRIVE=00)	Texas Instruments	CSTNE16M0V530000R0	16.00	15	15	open	0	2.3	3.6	Consumer	SMD
MSP430x5xx (TX2:TX2DRIVE=00)	Texas Instruments	CSTNE16M0VH3L000R0	16.00	15	15	open	0	2.3	3.6	Consumer	SMD
MSP430x5xx (TX2:TX2DRIVE=00)	Texas Instruments	CSTNE20M0V530000R0	20.00	15	15	open	0	2.3	3.6	Consumer	SMD
MSP430x5xx (TX2:TX2DRIVE=10)	Texas Instruments	CSTNE20M0VH3L000R0	20.00	15	15	open	0	2.3	3.6	Consumer	SMD

7 Notice

Notice (Soldering and Mounting)

Please contact us regarding ultrasonic cleaning conditions to avoid possible damage.

Notice (Storage and Operating Conditions)

Please do not apply excess mechanical stress to the component and lead terminals at soldering.

Notice (Rating)

The component may be damaged if excess mechanical stress is applied.

Notice (Handling)

- Unstable oscillation or oscillation stoppage might occur when CERALOCK is used in an improper way in conjunction with ICs. We are happy to evaluate the application circuit to help you avoid this.
- Oscillation frequency of our standard CERALOCK is adjusted with our standard measuring circuit. There could be slight shift in frequency if other types of IC are used. When you require exact oscillation frequency in your application, please contact us.

8 Appendix Equivalent Circuit Constants of CERALOCK

(The equivalent circuit constants are not the guaranteed value but the standard value.)

MHz band lead CERALOCK

Part Number	Equivalent Constant	Fr (kHz)	Fa (kHz)	ΔF (kHz)	R ₁ (Ω)	L ₁ (mH)	C ₁ (pF)	C ₀ (pF)	Q _m
CSTLS4M00G53-BO		3784.4	4135.3	350.9	9	0.4611	3.8377	19.773	1220
CSTLS6M00G53-BO		5710.9	6199.5	488.6	7.5	0.2381	3.2635	18.2899	1135
CSTLS8M00G53-BO		7604.7	8246.3	641.6	8	0.1251	3.503	19.9175	775
CSTLS10M0G53-BO		9690.1	10399.1	709	7	0.0984	2.7448	18.0899	947
CSTLS16M0X55-BO		15972.9	16075	102.1	24.6	0.6572	0.1511	11.7835	2681
CSTLS20M0X53-BO		19959.2	20070.8	111.6	19	0.4858	0.1309	11.6716	3203
CSTLS24M0X53-BO		23955.8	24095.9	140.2	16.6	0.4205	0.105	8.944	3805
CSTLS27M0X51-BO		27024.3	27172.8	148.5	15.9	0.3638	0.0953	8.6486	3877
CSTLS32M0X51-BO		31918.4	32092.6	174.2	13.4	0.2481	0.1002	9.1542	3716
CSTLS33M8X51-BO		33777.8	33969.7	191.9	25.6	0.2561	0.0867	7.6093	2120
CSTLS36M0X51-BO		36033.6	36241.1	207.6	13.4	0.226	0.0863	7.47	3821
CSTLS40M0X51-BO		39997.7	40240.1	242.7	15.8	0.2301	0.0688	5.6544	3651
CSTLS50M0X51-BO		49946.3	50193.1	246.8	27.6	0.1856	0.0547	5.5234	2107

MHz band Chip CERALOCK

Part Number	Equivalent Constant	Fr (kHz)	Fa (kHz)	ΔF (kHz)	R ₁ (Ω)	L ₁ (mH)	C ₁ (pF)	C ₀ (pF)	Q _m
CSTCR4M00G55-R0		3895.4	4120.5	225.1	11.4	0.8824	1.8892	15.9054	1898
CSTNR4M00GH5C000R0		3931.5	4144.0	212.5	17.1	1.4115	1.1614	10.4612	2040
CSTCR6M00G55-R0		5839.5	6174.0	334.5	15.8	0.4232	1.7551	14.8932	986
CSTNE8M00G55000R0		7815.5	8261.0	445.5	10.2	0.2691	1.5413	13.1450	1334
CSTNE8M00GH5C000R0		7856.0	8252.0	396.0	12.2	0.3827	1.0728	10.3801	1582
CSTNE10M0G55000R0		9758.5	10336.8	578.3	7.9	0.1659	1.6043	13.1493	1327
CSTNE10M0GH5C000R0		9809.5	10343.5	534.0	12.5	0.2370	1.1121	9.9416	1197
CSTNE12M0G55000R0		11684.1	12393.3	709.2	6.2	0.1028	1.8065	14.4417	1297
CSTNE12M0GH5C000R0		11760.0	12427.5	667.5	5.5	0.1455	1.2606	10.8055	1985
CSTNE16M0V53000R0		15538.0	16555.0	1017.0	7.2	0.0930	1.1295	8.3546	1352
CSTNE16M0VH3C000R0		15552.5	16559.0	1006.5	8.5	0.0961	1.0903	8.1582	1165
CSTNE20M0V53000R0		19484.5	20726.5	1242.0	11.8	0.0669	0.9985	7.5900	699
CSTNE20M0VH3C000R0		19466.0	20718.5	1252.5	9.8	0.0668	1.0024	7.5466	840

Global Locations

For details please visit www.murata.com



⚠️ Note

1 Export Control

For customers outside Japan:

No Murata products should be used or sold, through any channels, for use in the design, development, production, utilization, maintenance or operation of, or otherwise contribution to (1) any weapons (Weapons of Mass Destruction [nuclear, chemical or biological weapons or missiles] or conventional weapons) or (2) goods or systems specially designed or intended for military end-use or utilization by military end-users.

For customers in Japan:

For products which are controlled items subject to the "Foreign Exchange and Foreign Trade Law" of Japan, the export license specified by the law is required for export.

2 Please contact our sales representatives or product engineers before using the products in this catalog for the applications listed below, which require especially high reliability for the prevention of defects which might directly damage a third party's life, body or property, or when one of our products is intended for use in applications other than those specified in this catalog.

- ① Aircraft equipment
- ② Aerospace equipment
- ③ Undersea equipment
- ④ Power plant equipment
- ⑤ Medical equipment
- ⑥ Transportation equipment (vehicles, trains, ships, etc.)
- ⑦ Traffic signal equipment
- ⑧ Disaster prevention / crime prevention equipment
- ⑨ Data-processing equipment
- ⑩ Application of similar complexity and/or reliability requirements to the applications listed above

3 Product specifications in this catalog are as of October 2019. They are subject to change or our products in it may be discontinued without advance notice. Please check with our sales representatives or product engineers before ordering. If there are any questions, please contact our sales representatives or product engineers.

4 Please read rating and ⚠️CAUTION (for storage, operating, rating, soldering, mounting and handling) in this catalog to prevent smoking and/or burning, etc.

5 This catalog has only typical specifications. Therefore, please approve our product specifications or transact the approval sheet for product specifications before ordering.

6 Please note that unless otherwise specified, we shall assume no responsibility whatsoever for any conflict or dispute that may occur in connection with the effect of our and/or a third party's intellectual property rights and other related rights in consideration of your use of our products and/or information described or contained in our catalogs. In this connection, no representation shall be made to the effect that any third parties are authorized to use the rights mentioned above under licenses without our consent.

7 No ozone depleting substances (ODS) under the Montreal Protocol are used in our manufacturing process.

Murata Manufacturing Co., Ltd.

www.murata.com

muRata
INNOVATOR IN ELECTRONICS