

IRA-E710ST0

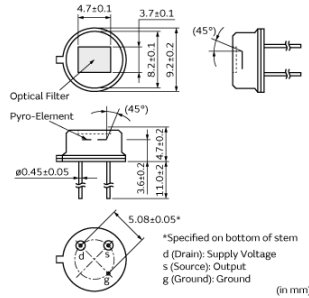

Appearance & Shape

Features



Lead type

Applications

Limited Usage	Recommendet IRA-S210ST01
Other Usage	Not available for Automotive usage.

Packaging Information

Packaging	Specifications	Minimum Order Quantity
-	Box	100

Attention

- 1.This datasheet is downloaded from the website of Murata Manufacturing Co., Ltd. Therefore, it's specifications are subject to change or our products in it may be discontinued without advance notice. Please check with our sales representatives or product engineers before ordering.
- 2.This datasheet has only typical specifications because there is no space for detailed specifications.
Therefore, please review our product specifications or consult the approval sheet for product specifications before ordering.

IRA-E710ST0

Specifications

Operating Temperature Range	-40°C to 70°C
Shape	Lead
Field of View	theta1=theta2=45deg.
Electrode	(2.0x1.0mm)x2
Responsivity(typ.)	4.3mV
Optical Filter	5micro meter Long Pass
Supply Voltage Range	2V to 15V
Storage Temperature Range	-40°C to 85°C

Attention

1.This datasheet is downloaded from the website of Murata Manufacturing Co., Ltd. Therefore, it's specifications are subject to change or our products in it may be discontinued without advance notice. Please check with our sales representatives or product engineers before ordering.

2.This datasheet has only typical specifications because there is no space for detailed specifications.

Therefore, please review our product specifications or consult the approval sheet for product specifications before ordering.

IRA-E710ST0

Product Data

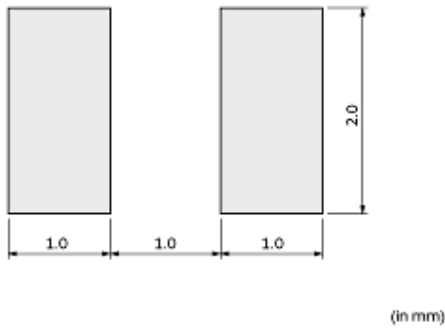

Pyroelectric Element

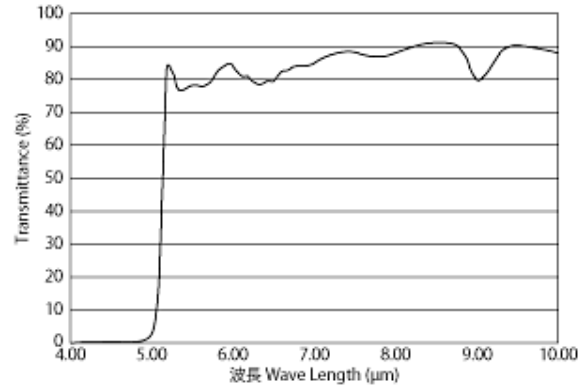

Filter characteristics

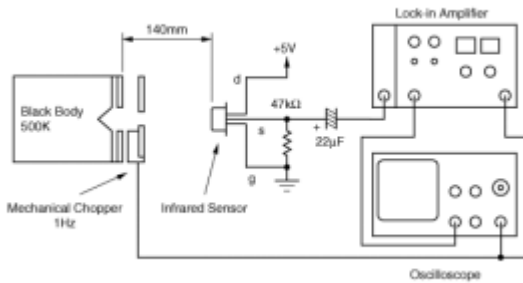

Test circuit

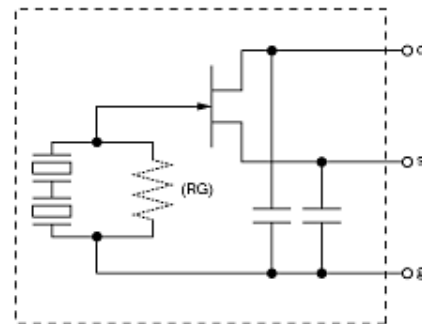

Circuit diagrams

Attention

1.This datasheet is downloaded from the website of Murata Manufacturing Co., Ltd. Therefore, it's specifications are subject to change or our products in it may be discontinued without advance notice. Please check with our sales representatives or product engineers before ordering.
2.This datasheet has only typical specifications because there is no space for detailed specifications.
Therefore, please review our product specifications or consult the approval sheet for product specifications before ordering.