

UHF RFID Long Range Antenna Data sheet LXRFZZUCCA-034(JP/US) / 035(EU)

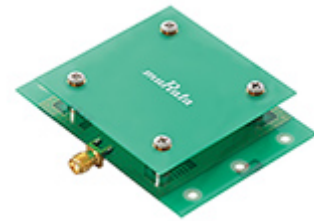

1. General Descriptions

LXRFZZUCCA-034 (JP/US) and LXRFZZUCCA-035(EU) are UHF long range antenna



[Features]

- Optimized antenna design for Murata tag
- FCC / IC / ETSI / Japan Radio law certified device
(FCC ID: VPYLXRF032, IC: 772C-LXRF032, JP: 007-AF0012, CE Mark is acquired)
- SMA connection (reverse polarity)
- 100% green material for RoHS compliance
- Related product name

	EU	JP	US/Canada
Evaluation Kit*	LXRFZZUAAA-029-KIT	LXRFZZUAAA-031-KIT	LXRFZZUAAA-033-KIT
Reader writer	LXRFZZUAAA-027	LXRFZZUAAA-030	LXRFZZUAAA-032
Short Range Antenna	LXRFZZUCCA-037	LXRFZZUCCA-036	LXRFZZUCCA-036
Long Range Antenna	LXRFZZUCCA-035	LXRFZZUCCA-034	LXRFZZUCCA-034
Interface Board	LXRFZZUBBA-042		

*A reader writer, a short range antenna, a long range antenna, an interface board, cables are included in Evaluation Kit.

All Rights Reserved, Copyright© Murata Manufacturing Co., Ltd.

< Specification is subject to change without notice >

2. Mechanical Information

[Dimension]

<Top View>

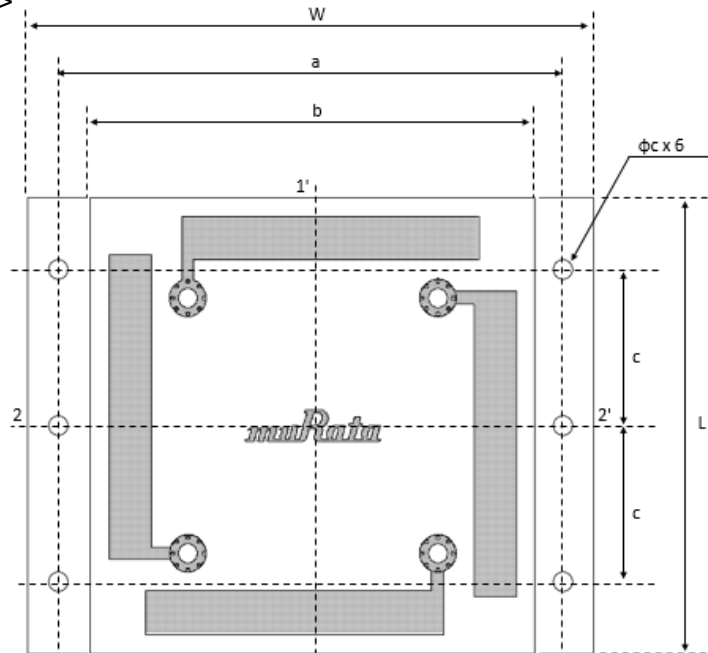

<Side View>

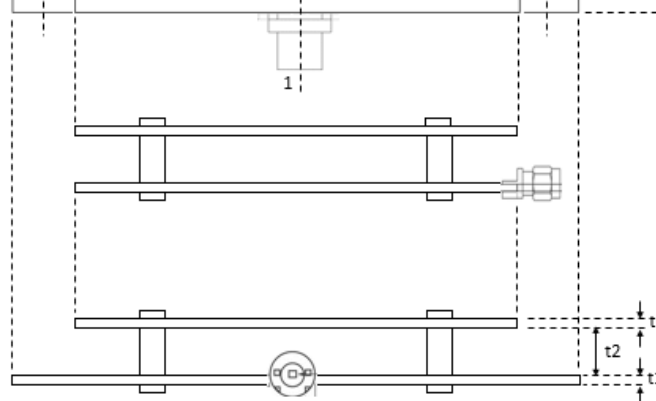

Mark	Size	Mark	Size
L	93.0 +/- 0.3	c	25.0 +/- 0.2
W	73.0 +/- 0.3	φc	3.2 +/- 0.1
a	83.0 +/- 0.2	t1	0.8 +0.2 / -0.1
b	73.0 +/- 0.2	t2	10.0 +/- 0.1

Connector type : RP-SMA(female)

All Rights Reserved, Copyright© Murata Manufacturing Co., Ltd.

< Specification is subject to change without notice >

3. Characteristics

3-1. Radiation Pattern

Linear Polarization

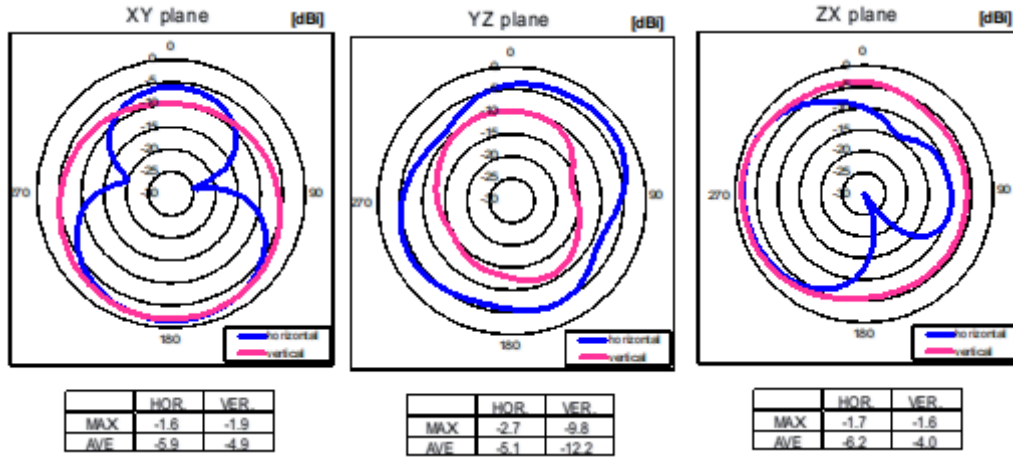

Circular Polarization

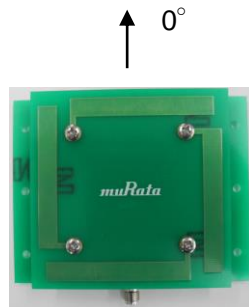
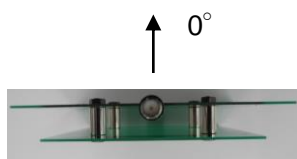
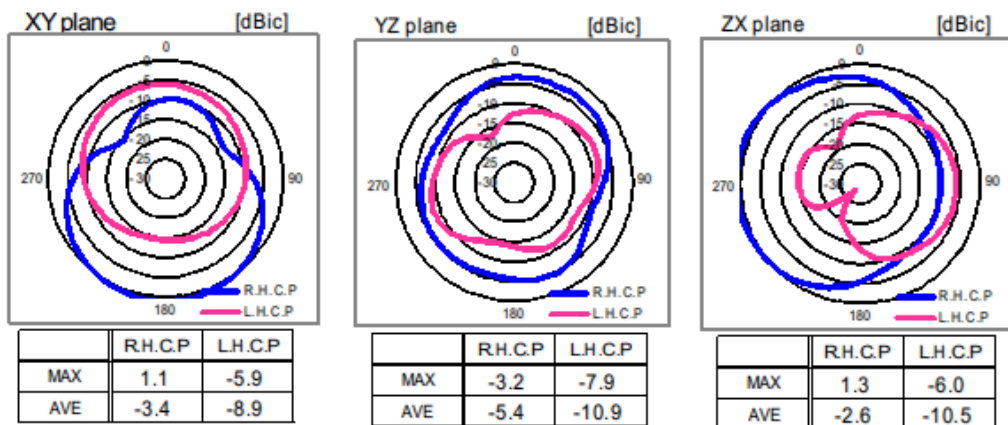

All Rights Reserved, Copyright© Murata Manufacturing Co., Ltd.

< Specification is subject to change without notice >

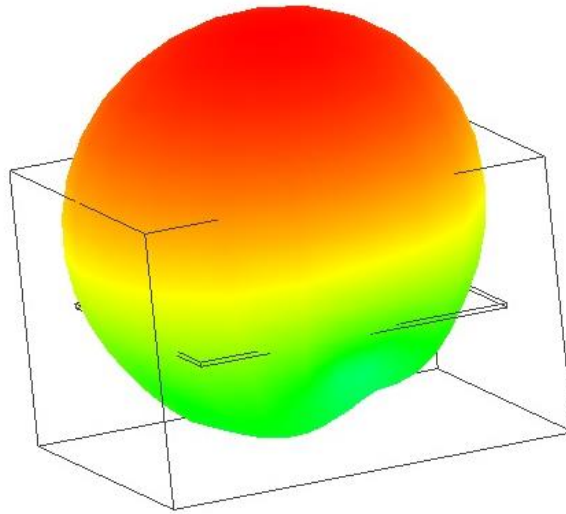

*This pattern of a long range antenna measured on metal plate.

3-2. Return Loss

LXRFFZUCCA-036 (JP/US)

Parameter	Min	Typ	Max	Unit
Return Loss (@920MHz)			-10	dB

LXRFFZUCCA-036 (JP/US)

Parameter	Min	Typ	Max	Unit
Return Loss (@866MHz)			-10	dB

3-3. Ratings

3-3-1. Limiting values

Parameter	Symbol	Limiting values		Unit
		Min	Max	
Storage temperature	T _{STG}	-40	+85	°C

3-3-2. Operation condition

Parameter	Symbol	Min	Typ	Max	Unit
Ambient Temperature	T _{amb}		25		°C

4. Packaging

4-1 Quantities per 1 carton

10pcs / Carton

4-2 Minimum order quantity

10pcs

5. Contact window

URL: <http://www.murata.com/en-global/products/rfid>

Email: magicstrap@murata.com

For any inquiries, please feel free to contact us.

NOTICE

1. Storage Conditions:

To avoid damaging, be sure to observe the following points.

- Store products where the ambient temperature is 15 to 35 °C and humidity 45 to 75% RH.
(Packing materials, In particular, may be deformed at the temperature over 40 °C.).
- Store products in non corrosive gas (Cl₂, NH₃, SO₂, NO_x, etc.).
- Stored products should be used within 6 months of receipt.

2. Handling Conditions:

Be careful in handling or transporting products because excessive stress or mechanical shock may break products.



Note:

Please make sure that your product has been evaluated and confirmed against your specifications when our product is applied to your product.

All the items and parameters in this product specification have been prescribed on the premise that our product is used for the purpose, under the condition and in the environment agreed upon between you and us. You are requested not to use our product deviating from such agreement.