

# Reference Only

Spec.No. JENF243H-0008P-01

P 1/ 15

## SMD Block Type EMIFIL    **BNX02□-01□**    Reference Specification

### 1.Scope

This reference specification applies to SMD Block Type EMIFIL.

### 2.Part Numbering

BN  
Product ID
X  
Type
022  
Serial No.
-01  
Features
L  
Packaging Code

(L :Taping(φ178mm reel) / K :Taping(φ330mm reel) / B :Bulk)

### 3.Rating

Customer's Part Number	Part Number	Capacitance	Rated Voltage	Withstandin g Voltage	Rated Current *	DC Resistance	Insulation Resistance	Insertion Loss	Voltage Drop
	BNX022-01L	1.0μF±15%	50V (DC)	125V (DC)	20A (DC)	0.43mΩ ±0.20mΩ	500MΩ min.	35dB min. (1MHz to 1GHz)	30 mV max.
	BNX022-01K								
	BNX022-01B								
	BNX023-01L	1.0μF±15%	100V (DC)	250V (DC)	20A (DC)	0.43mΩ ±0.20mΩ	500MΩ min.	35dB min. (1MHz to 1GHz)	45mV max.
	BNX023-01K								
	BNX023-01B								
	BNX028-01L	47μF± <sup>20%</sup> / <sub>50%</sub>	16V (DC)	40V (DC)	20A (DC)	0.43mΩ ±0.20mΩ	1.1MΩ min.	35dB min. (30KHz~ 1GHz)	45mV max.
	BNX028-01K								
	BNX028-01B								
	BNX029-01L	100μF± <sup>20%</sup> / <sub>50%</sub>	6.3V (DC)	15.8V (DC)	20A (DC)	0.43mΩ ±0.20mΩ	0.5MΩ min.	35dB min. (15KHz~ 1GHz)	45mV max.
	BNX029-01K								
	BNX029-01B								

\* Rated current is derated according to operating temperature.

BNX022-01  
BNX023-01  
BNX029-01

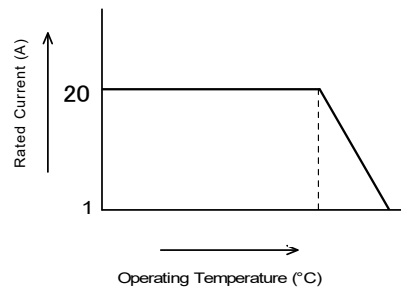
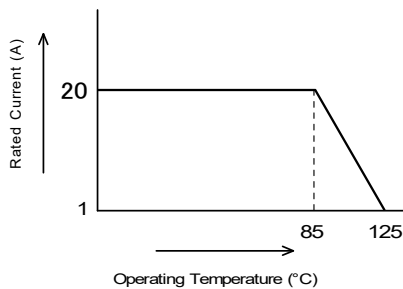

- Operating Temperature : - 40 °C to + 125 °C (BNX022-01/ BNX023-01/ BNX029-01)  
- 40 °C to + 105 °C (BNX028-01)
- Storage Temperature : - 55 °C to + 125 °C

### 4.Standard Testing Condition

<Unless otherwise specified>

Temperature : Ordinary Temp. 15 °C to 35 °C  
Humidity : Ordinary Humidity 25 %(RH) to 85 %(RH)

<In case of doubt>

Temperature : 20 °C ± 2 °C  
Humidity : 60 %(RH) to 70 %(RH)  
Atmospheric pressure : 86kPa to 106kPa

**5.Style and Dimensions**

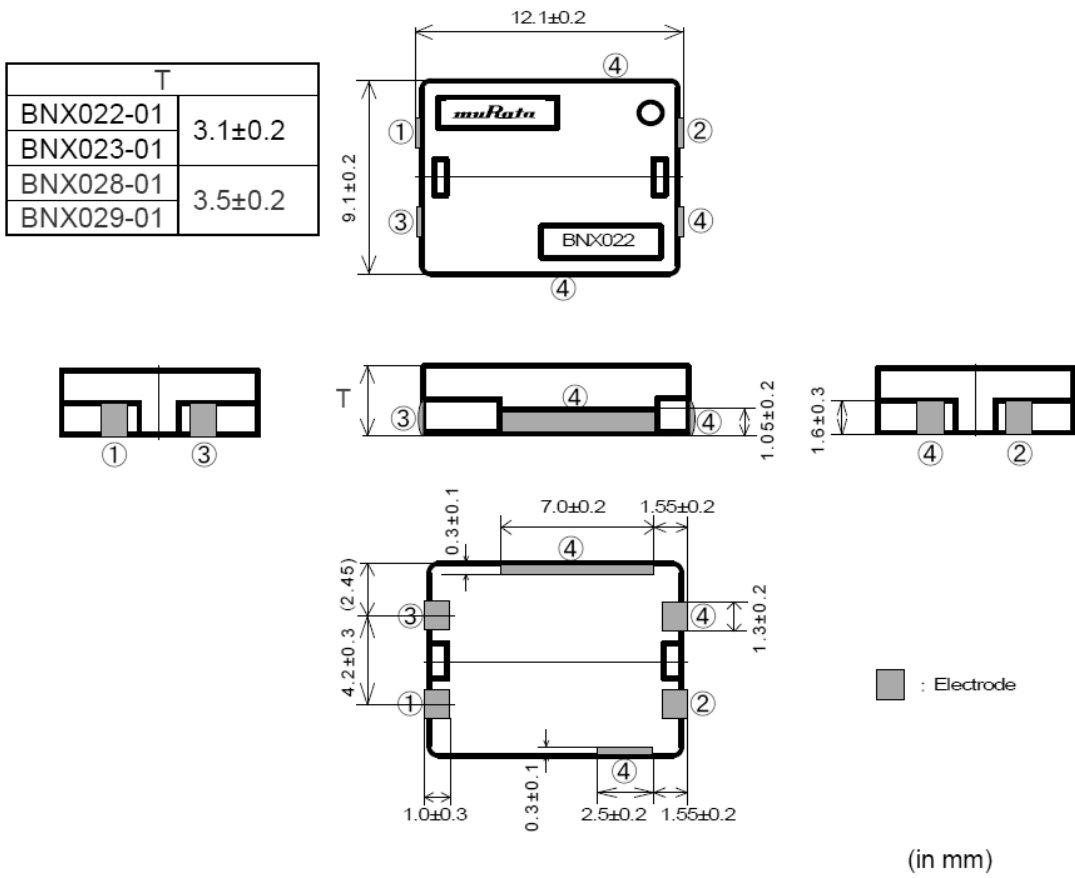

※Coplanarity 0.10mm max

■Equivalent Circuit

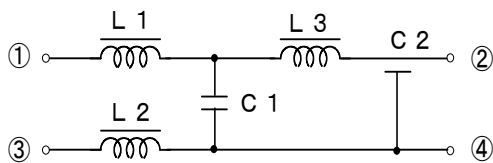

■ Unit Mass (Typical value)  
0.80g

**6.Marking**

Filter shall be marked as follows.

- (1) Murata Mark : **muRata**
- (2) Part Number : BNX022-01 : ( BNX022 )  
 BNX023-01 : ( BNX023 )  
 BNX028-01 : ( BNX028 )  
 BNX029-01 : ( BNX029 )
- (3) Polarity Marking : ○

# Reference Only

## 7. Electrical Performance

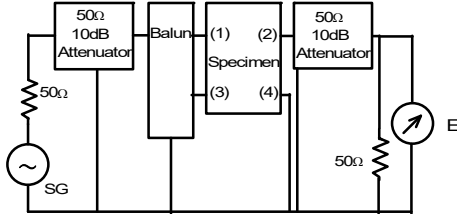
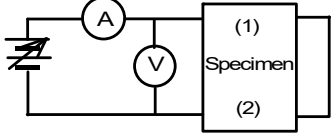
No.	Item	Specification	Test Method
7.1	Insertion Loss	Meet item 3.	 <p>*Method of measurement based on MIL-STD-220            Insertion Loss = <math>-20 \log E_1/E_0</math> (dB)            E<sub>0</sub> : Level without FILTER (short)            E<sub>1</sub>: Level with FILTER</p>
7.2	Capacitance		Measured by the following condition between Terminal ①② and ③④. (see item 5.) Frequency : 1 ± 0.1kHz (BNX022/BNX023) 120±24Hz (BNX028/BNX029) Voltage : 1 V(rms) max. (BNX022/BNX023) 0.5±0.1V(rms). (BNX028/BNX029) Measuring Equipment : Agilent4278A or the equivalent (BNX022/BNX023) Agilent4284A or the equivalent (BNX028/BNX029)
7.3	DC Resistance		Measured by the way of 4 terminal method between ① and ② and between ③ and ④. (see item 5.)
7.4	Insulation Resistance		Measured at DC rated voltage between terminal ①② and ③④. (see item 5.) Time : 60 s max Charging current : 50 mA max. Measuring Equipment : R8340A or the equivalent
7.5	Withstanding Voltage	Filter shall be no failure.	Withstanding voltage shall be applied between terminal ①② and ③④. (see item 5.) Test Voltage : BNX022-01 125V(DC) BNX023-01 250 V(DC) BNX028-01 40 V(DC) BNX029-01 15.8 V(DC) Time : 5 ± 1 s Charging current : 50 mA max.
7.6	Voltage Drop	Meet item 3.	After soldering the part on the test substrate, measure the voltage with passing the rated current as shown in the schematic below.  <p>Where the terminals of the part shall be connected as follows:            Referring to the terminal No. shown in item 5, connect terminal No. ② and ④ by soldering copper wire with diameter more than 1mm / length less than 6mm.            Then connect terminal No. ① as (1) and terminal No. ③ as (2) the measurement circuit as mentioned above.            The probe for measuring the voltage shall be touched on the solder fillet of ①③.</p>

# Reference Only

## 8.Mechanical Performance

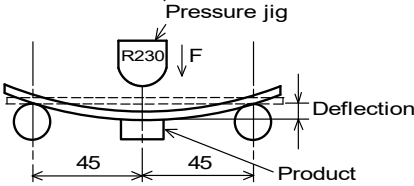
No.	Item	Specification	Test Method
8.1	Appearance and Dimensions	Meet item 5.	Visual Inspection and measured with Micrometer caliper and Slide Caliper.
8.2	Marking	Meet item 5.	Visual Inspection
8.3	Reflow Solderability	Appropriate solder fillet is formed.	It shall be soldered with the Standard Profile condition as shown No.13.6(2) Soldering Condition. <ul style="list-style-type: none"> <li>· thickness of solder paste : 150 to 200 μm</li> <li>· Land dimension : see No.13.5.</li> </ul>
8.4	Resistance to soldering iron	Meet Table 1. <u>Table 1</u>	Soldering iron : 100 W max. Tip Temperature : 450 °C ± 5 °C Soldering Time : 5 s , 2 Times Do not touch the products directly with the tip of the soldering iron.  <About BNX028,BNX029> <ul style="list-style-type: none"> <li>· Initial values: measured after heat treatment (150±<sup>0</sup><sub>10</sub> °C, 1hour) and exposure in the room condition for 24±2 hours.</li> <li>· Values After Testing:measured after heat treatment (150±<sup>0</sup><sub>10</sub> °C, 1hour) and exposure in the room condition for 24±2 hours.</li> </ul>
8.5	Bending Strength		It shall be soldered on the glass-epoxy substrate. (100mm×40mm×1.6mm) <div style="text-align: center;">  <p style="text-align: center;">Pressure jig R230 ↓ F Deflection Product 45 45</p> </div> Deflection : 2 mm Keeping Time : 30 s Speed : 0.5 mm/s  <About BNX028,BNX029> <ul style="list-style-type: none"> <li>· Initial values: measured after heat treatment (150±<sup>0</sup><sub>10</sub> °C, 1hour) and exposure in the room condition for 24±2 hours.</li> <li>· Values After Testing:measured after heat treatment (150±<sup>0</sup><sub>10</sub> °C, 1hour) and exposure in the room condition for 24±2 hours.</li> </ul>
8.6	Drop	Meet Table 2. <u>Table 2</u>	It shall be dropped on concrete or steel board. Method : free fall Height : 1 m The Number of Time : 10 times  <About BNX028,BNX029> <ul style="list-style-type: none"> <li>· Initial values: measured after heat treatment (150±<sup>0</sup><sub>10</sub> °C, 1hour) and exposure in the room condition for 24±2 hours.</li> <li>· Values After Testing:measured after heat treatment (150±<sup>0</sup><sub>10</sub> °C, 1hour) and exposure in the room condition for 24±2 hours.</li> </ul>



# Reference Only

No.	Item	Specification	Test Method
9.2	Humidity Life ①	Meet Table 3. <u>Table 3</u>	Temperature : $60 \pm 2$ °C Humidity : 90 ~ 95 %(RH) Voltage : Rated Voltage Time : 1000 h (+ 48h , - 0h) Then measure values after exposure in the room condition for $48 \pm 4$ hours.  <About BNX028,BNX029> ・ Initial values: measured after heat treatment ( $150 \pm 0_{10}$ °C, 1hour) and exposure in the room condition for $24 \pm 2$ hours. ・ Values After Testing:measured after heat treatment ( $150 \pm 0_{10}$ °C, 1hour) and exposure in the room condition for $24 \pm 2$ hours.
	Humidity Life ②		Temperature : $85 \pm 2$ °C Humidity : 80 ~ 85 %(RH) Voltage : Rated Voltage Time : 1000 h (+ 48h , - 0h) Then measure values after exposure in the room condition for $48 \pm 4$ hours.  <About BNX028,BNX029> ・ Initial values: measured after heat treatment ( $150 \pm 0_{10}$ °C, 1hour) and exposure in the room condition for $24 \pm 2$ hours. ・ Values After Testing:measured after heat treatment ( $150 \pm 0_{10}$ °C, 1hour) and exposure in the room condition for $24 \pm 2$ hours.
9.3	Heat Life	Meet Table 4. <u>Table 4</u>	Temperature : $125 \pm 2$ °C Voltage : Rated Voltage $\times 2$ Time : 1000 h (+ 48h , - 0h) Then measure values after exposure in the room condition for $48 \pm 4$ hours.  <About BNX028,BNX029> ・ Initial values: measured after heat treatment ( $150 \pm 0_{10}$ °C, 1hour) and exposure in the room condition for $24 \pm 2$ hours. ・ Values After Testing:measured after heat treatment ( $150 \pm 0_{10}$ °C, 1hour) and exposure in the room condition for $24 \pm 2$ hours.

## 10. Insertion Loss Characteristics (I.L.) (Typ.)

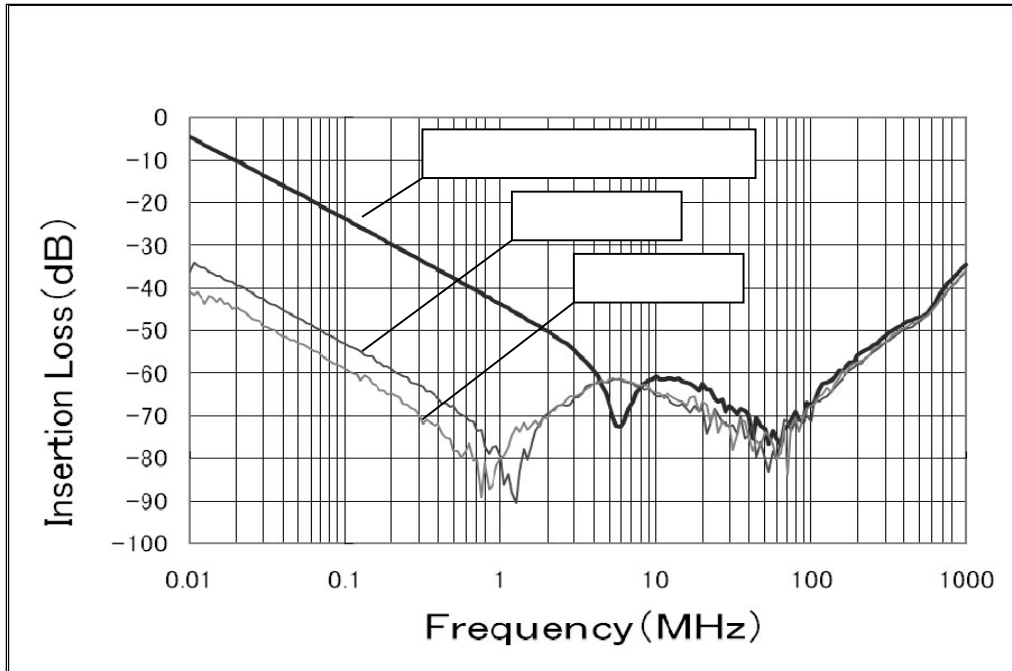

## 11. Specification of Packaging

### 11.1 Appearance and Dimensions (24mm-wide plastic tape)

(1) plastic tape

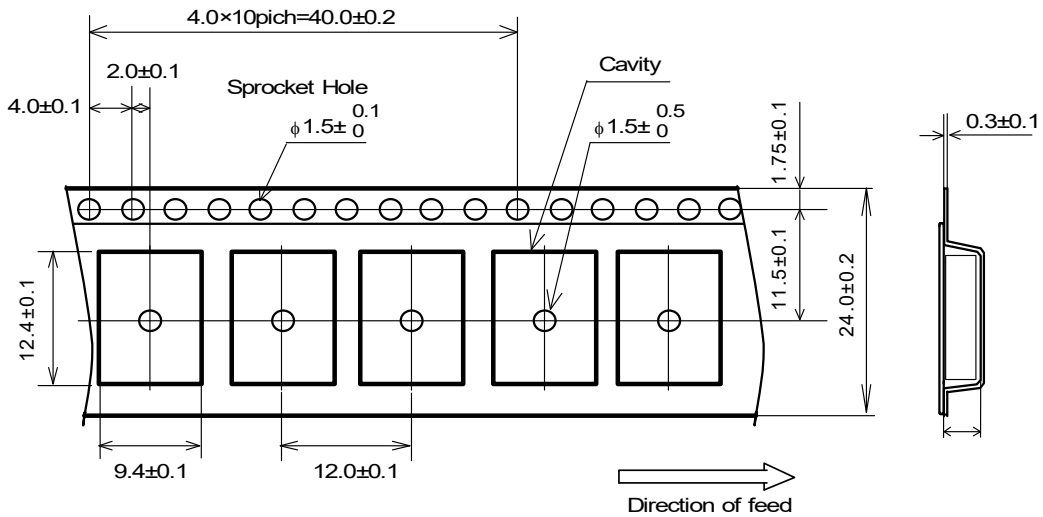

(in:mm)

\*Dimension of the Cavity is measured at the bottom side.

(2)Direction of the product

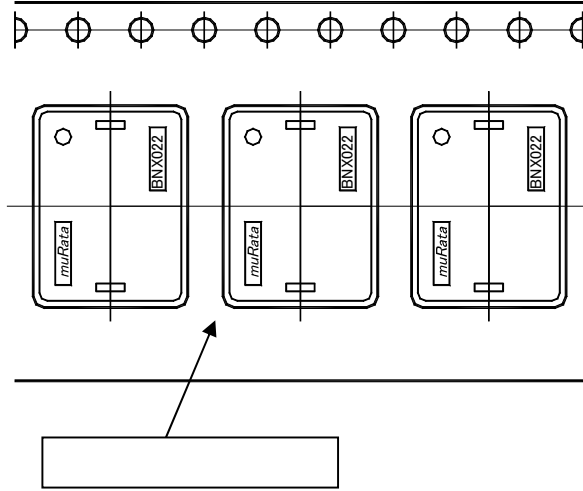

### 11.2 Specification of Taping

- (1) Packing quantity (standard quantity)
  - φ178mm reel : 400 pcs. / reel
  - φ330mm reel : 1500 pcs. / reel
- (2) Packing Method
 

Products shall be packaged in the cavity of the plastic tape and sealed with cover tape.
- (3) Spliced point
 

The cover tape have no spliced point.
- (4) Sprocket Hole
 

The sprocket holes are to the right as the tape is pulled toward the user.
- (5) Missing components number
 

Missing components number within 0.025% of the number per reel or 1 pc., whichever is greater, and are not continuous. The specified quantity per reel is kept.

### 11.3 Pull Strength of Plastic Tape and Cover Tape

Plastic tape	10N min.
Cover tape	

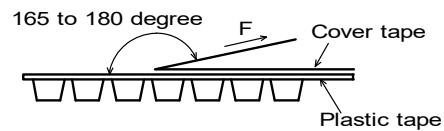

### 11.4 Peeling off force of Cover tape

- 0.2N to 0.7N (minimum value is typical)  
 \* Speed of Peeling off : 300 mm / min



# Reference Only

## 11.5 Dimensions of Leader-tape, Trailer and Reel

There shall be leader-tape (top tape and empty tape) and trailer-tape (empty tape) as follows.

[ Packaging Code:L ( $\phi$ 178mm reel) ]

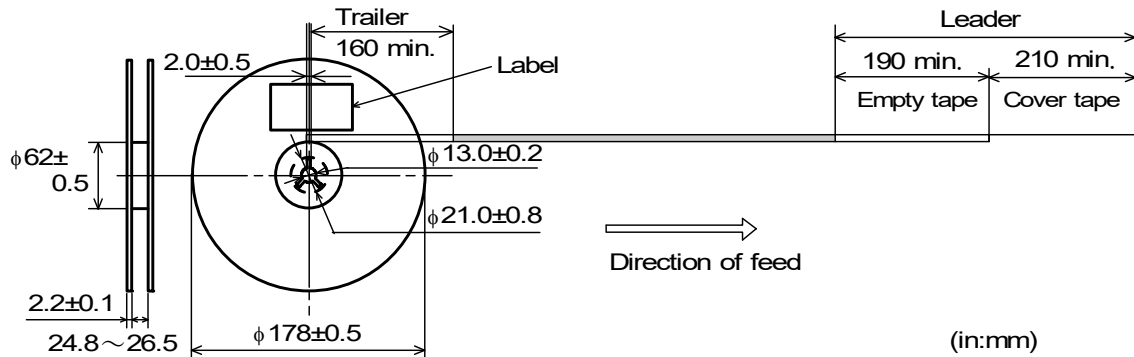

[ Packaging Code:K ( $\phi$ 330mm reel) ]

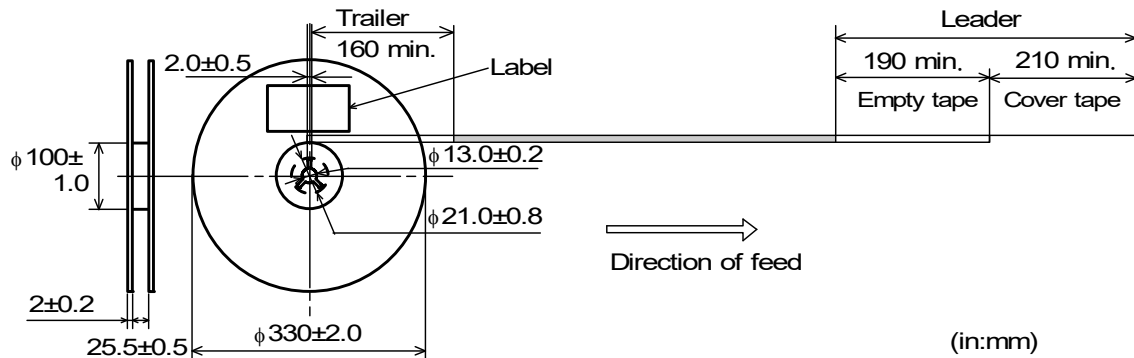

## 11.6 Marking for reel

Customer part number, MURATA part number, Inspection number(\*1), RoHS marking (\*2), Quantity, etc

\*1) « Expression of Inspection No. »       $\square\square$      $\text{O O O O}$      $\times\times\times$   
   (1)        (2)        (3)

(1) Factory Code

(2) Date                      First digit                : Year / Last digit of year

                                      Second digit             : Month / Jan. to Sep.  $\rightarrow$  1 to 9, Oct. to Dec.  $\rightarrow$  O,N,D

                                      Third, Fourth digit : Day

(3) Serial No.

\*2) « Expression of RoHS marking »      ROHS -  $\underline{Y}$  ( $\triangle$ )  
   (1) (2)

(1) RoHS regulation conformity parts.

(2) MURATA classification number

### 11.7 Marking for Outside package (corrugated paper box)

Customer name, Purchasing Order Number, Customer Part Number, MURATA part number, RoHS discrimination(\*2) , Quantity , etc

### 11.8 Specification of Outer Case

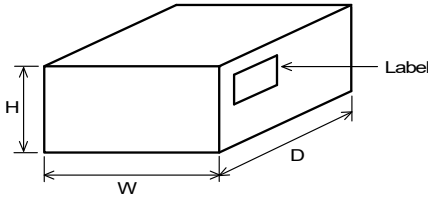

Reel	Outer Case Dimensions (mm)			Standard Reel Quantity in Outer Case (Reel)
	W	D	H	
φ178mm	186	186	93	3
φ330mm	340	340	85	2

\* Above Outer Case size is typical. It depends on a quantity of an order.

## 12. Caution

### 12.1.Direction of mounting

Please make sure of the direction of mounting and connect to the circuit properly.  
As shown in the equivalent circuit shown in item 5, this product has a directionality.  
Wrong connection to the circuit may cause open/short circuit of the part, burnout and serious accidents.

### 12.2.Limitation of Applications

Please contact us before using our products for the applications listed below which require especially high reliability for the prevention of defects which might directly cause damage to the third party's life,body or property.

- (1)Aircraft equipment (2)Aerospace equipment (3)Undersea equipment (4)Power plant control equipment
- (5)Medical equipment (6)Transportation equipment(automobiles,trains,ships,etc.) (7)Traffic signal equipment
- (8)Disaster prevention / crime prevention equipment (9)Data-processing equipment
- (10)Applications of similar complexity or with reliability requirements comparable to the applications listed in the above

### 12.3.ESD

ESD to this product, exceeding condition of IEC61000-4-2 with 30kV, may cause short circuit and fuming or firing.

### 12.4 Corrosive gas

Please refrain from use since contact with environments with corrosive gases (sulfur gas [hydrogen sulfide, sulfur dioxide, etc.], chlorine, ammonia, etc.) or oils (cutting oil, silicone oil, etc.) that have come into contact with the previously stated corrosive gas environment will result in deterioration of product quality or an open from deterioration due to corrosion of product electrode, etc. We will not bear any responsibility for use under these environments.

## 13.Notice

Products can only be soldered with reflow.  
This product is designed for solder mounting.  
Please consult us in advance for applying other mounting method such as conductive adhesive.

### 13.1. Flux and Solder

Flux	Use rosin-based flux, Do not use highly acidic flux (with chlorine content exceeding 0.2(wt)%). Do not use water soluble flux.
Solder	Use Sn-3.0Ag-0.5Cu solder

Other flux (except above) Please contact us for details, then use.

### 13.2. Note for Assembling

**<Exclusive Use of Reflow Soldering>**

When installing by the flow soldering, the degradation of the insulation resistance sometimes occurs.

Products can only be soldered with reflow.

The use in flow soldering be reserved.

**< Thermal Shock >**

Pre-heating should be in such a way that the temperature difference between solder and products surface is limited to 100 °C max. Also cooling into solvent after soldering should be in such a way that the temperature difference is limited to 100 °C max.

Insufficient pre-heating may cause cracks on the ferrite, resulting in the deterioration of product quality.

### 13.3. Attention Regarding P.C.B. Bending

The following shall be considered when designing P.C.B.'s and laying out products.

(1) P.C.B. shall be designed so that products are not subject to the mechanical stress for board warpage.

[Products direction]

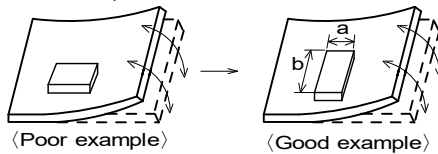

Products shall be located in the sideways direction (Length:  $a < b$ ) to the mechanical stress.

(2) Components location on P.C.B. separation.

It is effective to implement the following measures, to reduce stress in separating the board.

It is best to implement all of the following three measures; however, implement as many measures as possible to reduce stress.

Contents of Measures	Stress Level
(1) Turn the mounting direction of the component parallel to the board separation surface.	A > D *1
(2) Add slits in the board separation part.	A > B
(3) Keep the mounting position of the component away from the board separation surface.	A > C

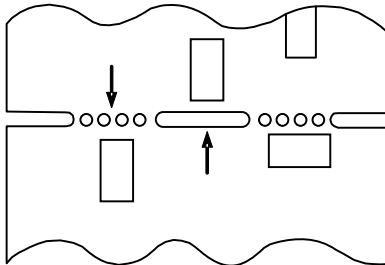

\*1 A > D is valid when stress is added vertically to the perforation as with Hand Separation.  
If a Cutting Disc is used, stress will be diagonal to the PCB, therefore A > D is invalid.

(3) Mounting Components Near Screw Holes

When a component is mounted near a screw hole, it may be affected by the board deflection that occurs during the tightening of the screw. Mount the component in a position as far away from the screw holes as possible.

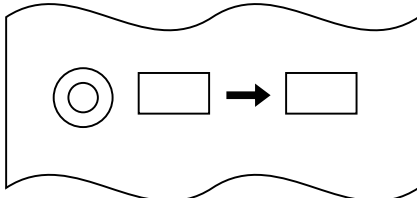

## 13.4. Attention Regarding P.C.B. Design

### < The Arrangement of Products >

P.C.B. shall be designed so that products are far from the portion of perforation.

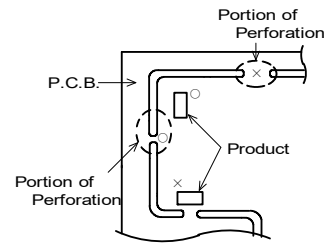

The portion of perforation shall be designed as narrow as possible, and shall be designed so as not to be applied the stress in the case of P.C.B. separation.

Products shall not be arranged on the line of a series of holes when there are big holes in P.C.B.

(Because the stress concentrate on the line of holes.)

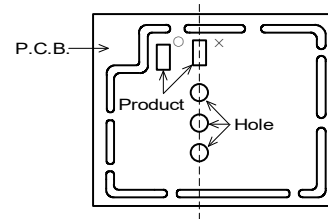

### < Products Placing >

Support pins shall be set under P.C.B. to prevent causing a warp to P.C.B. during placing the products on the other side of P.C.B.

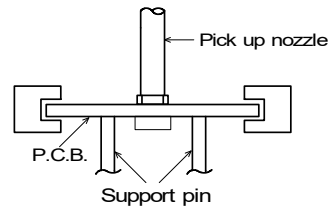

### < P.C.B. Separation >

P.C.B. shall not be separated with hand.

P.C.B. shall be separated with the fixture so as not to cause P.C.B. bending.

### 13.5. Standard Land Dimensions

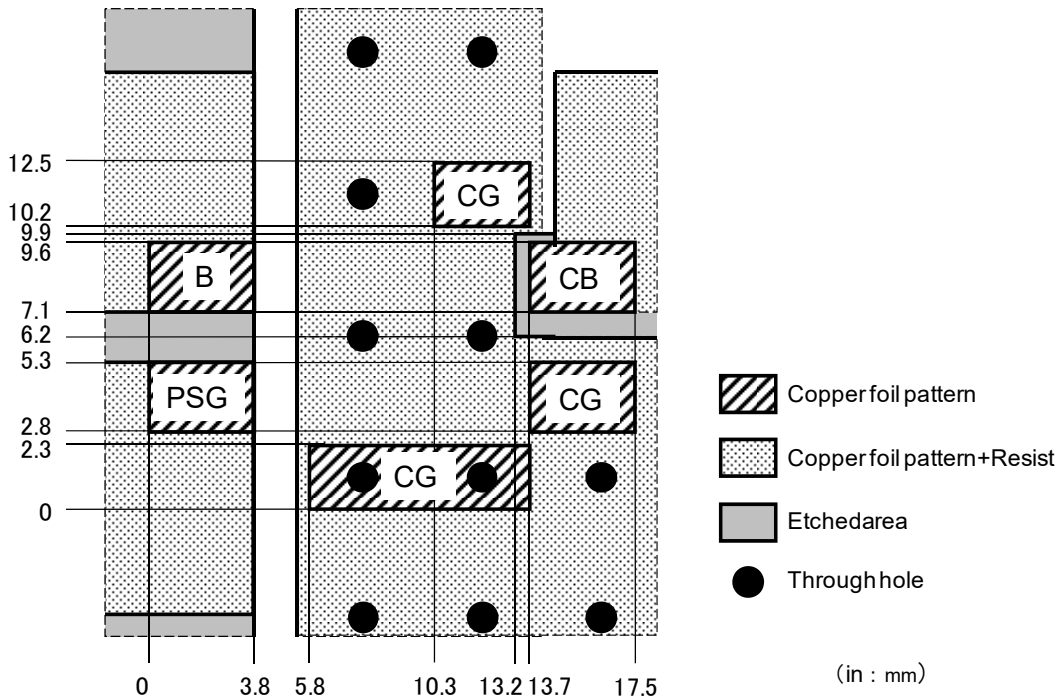

- (1) Design the land pads for this part as shown above on both side printed circuit board ( or a multiple layered substrate ).
- (2) This product is designed to meet large current.  
Please design PCB pattern which is connected to this product not to become too hot by applied large current.
- (3) Ground area of CG should be connected to ground layer on the other side (or ground layer of multiple layered substrate) with through holes as shown above.  
It is recommended to take the ground area as wide as possible.
- (4) It is recommended to use the connection to the ground layer with through holes and the ground layer to be circuit board wide.
- (5) Even in case that it isn't possible to use a both side printed circuit board ( or a multiple layered substrate ), the land pads for CG should be designed as wide as possible.

### 13.6. Reflow Soldering

- (1) Solder paste printing for reflow soldering
  - Standard thickness of solder paste should be 150 to 200  $\mu\text{m}$ .  
Incidentally, depending on the reflow condition and the way of heat conduction, the solder would not wet up the terminal, being possible to lead to not enough connection between terminals and lands on the circuit board / open circuit in the circuit board. In case of use, always evaluate this part in your products with actual use condition.
  - For the solder paste printing pattern, use standard land dimensions.
  - For the resist and copper foil pattern, use standard land dimensions.
  - Use Sn / Pn = 60 / 40 or Sn-3.0Ag-0.5Cu solder

**(2) Soldering Conditions**

Standard soldering profile and the limit soldering profile is as follows.

The excessive soldering conditions may cause leaching of the electrode and/or resulting in the deterioration of product quality.

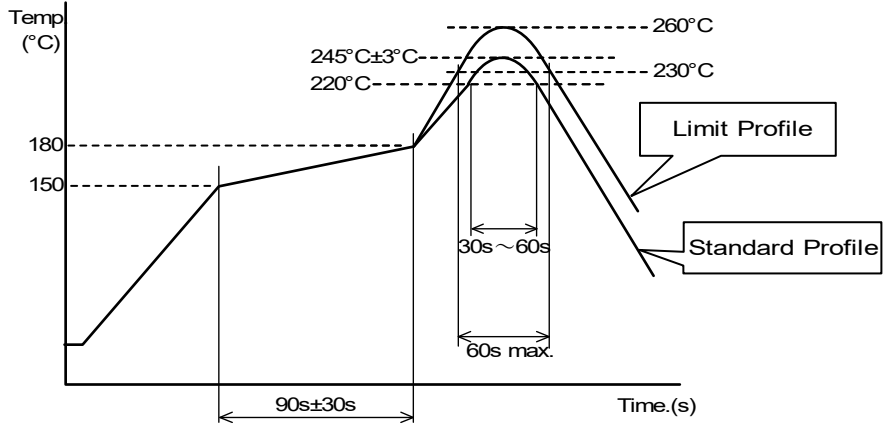

	Standard Profile	Limit Profile
Pre-heating	150°C ~ 180°C , 90s ± 30s	
Heating	above 220°C , 30s ~ 60s	above 230°C , 60s max.
Peak temperature	245°C ± 3°C	260°C , 10s
Cycle of reflow	2 times	2 times

**13.7. Reworking with Soldering iron**

· The following conditions shall be strictly followed when using a soldering iron.

Pre-heating	150°C, 1 min
Tip temperature	450°C max.
Soldering iron output	100W max.
Soldering time	5s
Time	2 times

Note : Do not touch the products directly with the tip of the soldering iron.

**13.8. Cleaning Conditions**

Don't cleaning product due to non-waterproof construction.

**13.9. Operating Environment**

Do not use this product under the following environmental conditions, on deterioration of the performance, such as insulation resistance may result from the use.

- (1) in the corrodible atmosphere (acidic gases, alkaline gases, chlorine, sulfur gases, organic gases and etc.)
- (2) in the atmosphere where liquid such as organic solvent, may splash on the products.

**13.10. Handling of a substrate**

After mounting products on a substrate, do not apply any stress to the product caused by bending or twisting to the substrate when cropping the substrate, inserting and removing a connector from the substrate or tightening screw to the substrate.

Excessive mechanical stress may cause cracking in the product.

Bending

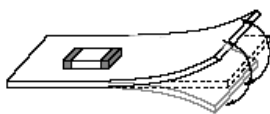

Twisting

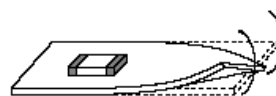

## 13.11 Storage condition

### (1) Storage period

Use the products within 12 months after delivered.  
Solderability should be checked if this period is exceeded.

### (2) Storage environment condition

- Products should be stored in the warehouse on the following conditions.
  - Temperature : - 10 °C to + 40 °C
  - Humidity : 15 % to 85% relative humidity No rapid change on temperature and humidity
- Don't keep products in corrosive gases such as sulfur, chlorine gas or acid, or it may cause oxidization of electrode, resulting in poor solderability.
- Products should be stored on the palette for the prevention of the influence from humidity, dust and so on.
- Products should be stored in the warehouse without heat shock, vibration, direct sunlight and so on.
- Avoid storing the product by itself bare (i.e.exposed directly to air).

### (3) Delivery

Care should be taken when transporting or handling product to avoid excessive vibration or mechanical shock.

## 14. Notes

- (1) Please make sure that your product has been evaluated in view of your specifications with our product being mounted to your product.
- (2) You are requested not to use our product deviating from the reference specifications.
- (3) The contents of this reference specification are subject to change without advance notice. Please approve our product specifications or transact the approval sheet for product specifications before ordering.