

FEATURES

- Efficiency up to 82%
- 3kVDC isolation 'Hi Pot Test'
- Wide temperature performance at full 1 Watt load, -40°C to 85°C
- Industry standard pinout
- Power sharing on output
- 3.3V, 5V & 12V inputs
- 3.3V, 5V, 9V, 12V & 15V outputs
- Internal SMD construction
- No external components required
- MTTF up to 1.6 Million hours
- No electrolytic or tantalum capacitors
- Pin compatible with NMA & MEA1 series

DESCRIPTION

The NKA sub-miniature series of industrial temperature range DC-DC converters are the standard building blocks for on-board distributed power systems. The series offers smaller package size, improved efficiency, lower output ripple and 3kVDC isolation capability through the use of state of the art packaging and technology. Ideally suited for providing dual rail supplies on primarily digital boards with the added benefit of galvanic isolation to reduce switching noise.

All of the rated power may be drawn from a single pin provided the total load does not exceed 1 watt.



For full details go to www.murata-ps.com/rohs

SELECTION GUIDE

Order Code	Nominal Input Voltage	Output Voltage	Output Current	Input Current at Rated Load	Efficiency	Isolation Capacitance	MTTF ¹	Package Style	Recommended Alternative
	V	V	mA		%	pF	kHrs		
Recommended					In Production				
NKA0305SC	3.3	±5	±100	383	79	22	1121	SIP	
NKA0312SC	3.3	±12	±42	390	78	31	375	SIP	
NKA0315SC	3.3	±15	±33	384	79	32	206	SIP	
NKA0503SC	5	±3.3	±152	259	77	22	205	SIP	
NKA0505SC	5	±5	±100	285	70	21	1697	SIP	
NKA0509SC	5	±9	±56	263	76	25	682	SIP	
NKA0512SC	5	±12	±42	255	78	28	343	SIP	
NKA0515SC	5	±15	±33	253	79	29	188	SIP	
NKA1205SC	12	±5	±100	112	74	33	559	SIP	
NKA1209SC	12	±9	±56	106	79	48	375	SIP	
NKA1212SC	12	±12	±42	104	81	55	243	SIP	
NKA1215SC	12	±15	±33	102	82	60	154	SIP	
NKA1215DC	12	±15	±33	102	82	60	154	DIP	
To be discontinued									
NKA0303SC	3.3	±3.3	±152	407	74	20	195	SIP	Contact Murata
NKA0312DC	3.3	±12	±42	390	78	31	375	DIP	Contact Murata
Discontinued									
NKA0303DC	3.3	±3.3	±152	407	74	20	195	DIP	NKA0303SC
NKA0305DC	3.3	±5	±100	383	79	22	1121	DIP	NKA0305SC
NKA0309DC	3.3	±9	±56	402	75	30	1035	DIP	Contact Murata
NKA0309SC	3.3	±9	±56	402	75	30	1035	SIP	Contact Murata
NKA0315DC	3.3	±15	±33	384	79	32	206	DIP	NKA0315SC
NKA0503DC	5	±3.3	±152	259	77	22	205	DIP	NKA0503SC
NKA0505DC	5	±5	±100	285	70	21	1697	DIP	NMA0505DC
NKA0505DEC	5	±5	±100	249	80	26	1557	DIP	NMA0505DC
NKA0505SEC	5	±5	±100	249	80	26	1557	SIP	NMA0505SC
NKA0509DC	5	±9	±56	263	76	25	682	DIP	NMA0509DC
NKA0512DC	5	±12	±42	255	78	28	343	DIP	NMA0512DC
NKA0515DC	5	±15	±33	253	79	29	188	DIP	NMA0515DC
NKA1205DC	12	±5	±100	112	74	33	559	DIP	NMA1205DC
NKA1209DC	12	±9	±56	106	79	48	375	DIP	NMA1209DC
NKA1212DC	12	±12	±42	104	81	55	243	DIP	NMA1212DC

NKA0505DEC/NKA0505SEC offer higher efficiency than NKA0505SC/NKA0505DC but over a narrower operating temperature range. See temperature characteristics graph.

INPUT CHARACTERISTICS

Parameter	Conditions	Min.	Typ.	Max.	Units
Voltage range	Continuous operation, 3.3V input types	2.97	3.3	3.63	V
	Continuous operation, 5V input types	4.5	5	5.5	
	Continuous operation, 12V input types	10.8	12	13.2	
Reflected ripple current	3.3V input types		30	60	mA p-p
	All other types		20	35	

1. Calculated using MIL-HDBK-217F with nominal input voltage at full load.

All specifications typical at T_a=25°C, nominal input voltage and rated output current unless otherwise specified.

OUTPUT CHARACTERISTICS					
Parameter	Conditions	Min.	Typ.	Max.	Units
Rated Power	T _A =-40°C to 120°C, see derating graphs			1	W
Voltage Set Point Accuracy	See tolerance envelope				
Line regulation	High V _{IN} to low V _{IN}		1.0	1.2	%/%
Load Regulation ¹	10% load to rated load, 0312 & 0315		8	14	%
	10% load to rated load, 3.3V output types		10	15	
	10% load to rated load, 5V output types		10	12	
	10% load to rated load, 9V output types		6.5	8	
	10% load to rated load, 12V output types		6	8.5	
	10% load to rated load, 15V output types		6	7	
Ripple and Noise	BW=DC to 20MHz, 0312 & 0315		25	60	mV p-p
	BW=DC to 20MHz, 3.3V output types		40	80	
	BW=DC to 20MHz, 5V output types		50	75	
	BW=DC to 20MHz, 9V output types		40	65	
	BW=DC to 20MHz, 12V output types		40	60	
	BW=DC to 20MHz, 15V output types		40	60	

ISOLATION CHARACTERISTICS					
Parameter	Conditions	Min.	Typ.	Max.	Units
Isolation test voltage	Flash tested for 1 second	3000			VDC
Resistance	Viso= 1000VDC		10		GΩ

GENERAL CHARACTERISTICS					
Parameter	Conditions	Min.	Typ.	Max.	Units
Switching frequency	0303, 0305, 0312, 0315, 0503 and 0505XE		95		kHz
	All other types		120		

TEMPERATURE CHARACTERISTICS					
Parameter	Conditions	Min.	Typ.	Max.	Units
Specification	All output types	-40		85	°C
Storage		-50		130	
Case temperature rise above ambient	5V output types		30		
	All other output types		21		
Cooling	Free air convection				

ABSOLUTE MAXIMUM RATINGS	
Lead temperature 1.5mm from case for 10 seconds	260°C
Wave Solder	Wave Solder profile not to exceed the profile recommended in IEC 61760-1 Section 6.1.3. Please refer to application notes for further information.
Input voltage V _{IN} , NKA03 types	5.5V
Input voltage V _{IN} , NKA05 types	7V
Input voltage V _{IN} , NKA12 types	15V

1. 12V input types have typically 3% less load regulation.

TECHNICAL NOTES

ISOLATION VOLTAGE

'Hi Pot Test', 'Flash Tested', 'Withstand Voltage', 'Proof Voltage', 'Dielectric Withstand Voltage' & 'Isolation Test Voltage' are all terms that relate to the same thing, a test voltage, applied for a specified time, across a component designed to provide electrical isolation, to verify the integrity of that isolation.

Murata Power Solutions NKA series of DC-DC converters are all 100% production tested at their stated isolation voltage. This is 1kVDC for 1 second.

A question commonly asked is, "What is the continuous voltage that can be applied across the part in normal operation?"

For a part holding no specific agency approvals, such as the NKA series, both input and output should normally be maintained within SELV limits i.e. less than 42.4V peak, or 60VDC. The isolation test voltage represents a measure of immunity to transient voltages and the part should never be used as an element of a safety isolation system. The part could be expected to function correctly with several hundred volts offset applied continuously across the isolation barrier; but then the circuitry on both sides of the barrier must be regarded as operating at an unsafe voltage and further isolation/insulation systems must form a barrier between these circuits and any user-accessible circuitry according to safety standard requirements.

REPEATED HIGH-VOLTAGE ISOLATION TESTING

It is well known that repeated high-voltage isolation testing of a barrier component can actually degrade isolation capability, to a lesser or greater degree depending on materials, construction and environment. The NKA series has toroidal isolation transformers, with no additional insulation between primary and secondary windings of enamelled wire. While parts can be expected to withstand several times the stated test voltage, the isolation capability does depend on the wire insulation. Any material, including this enamel (typically polyurethane) is susceptible to eventual chemical degradation when subject to very high applied voltages thus implying that the number of tests should be strictly limited. We therefore strongly advise against repeated high voltage isolation testing, but if it is absolutely required, that the voltage be reduced by 20% from specified test voltage.

This consideration equally applies to agency recognised parts rated for better than functional isolation where the wire enamel insulation is always supplemented by a further insulation system of physical spacing or barriers.

RoHS COMPLIANCE INFORMATION



This series is compatible with RoHS soldering systems with a peak wave solder temperature of 260°C for 10 seconds. Please refer to [application notes](#) for further information. The pin termination finish on the SIP package type is Tin Plate, Hot Dipped over Matte Tin with Nickel Preplate. The DIP types are Matte Tin over Nickel Preplate. Both types in this series are backward compatible with Sn/Pb soldering systems.

For further information, please visit www.murata-ps.com/rohs

PART NUMBER STRUCTURE

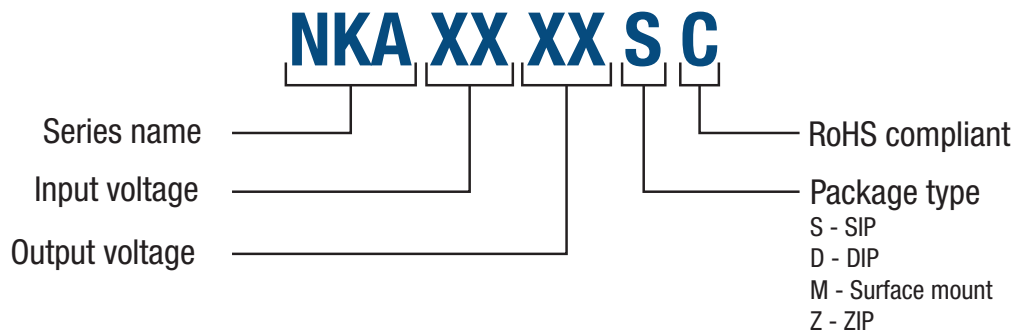

CHARACTERISATION TEST METHODS

Ripple & Noise Characterisation Method

Ripple and noise measurements are performed with the following test configuration.

C1	1µF X7R multilayer ceramic capacitor, voltage rating to be a minimum of 3 times the output voltage of the DC-DC converter
C2	10µF tantalum capacitor, voltage rating to be a minimum of 1.5 times the output voltage of the DC-DC converter with an ESR of less than 100mΩ at 100 kHz
C3	100nF multilayer ceramic capacitor, general purpose
R1	450Ω resistor, carbon film, ±1% tolerance
R2	50Ω BNC termination
T1	3T of the coax cable through a ferrite toroid
RLOAD	Resistive load to the maximum power rating of the DC-DC converter. Connections should be made via twisted wires

Measured values are multiplied by 10 to obtain the specified values.

Differential Mode Noise Test Schematic

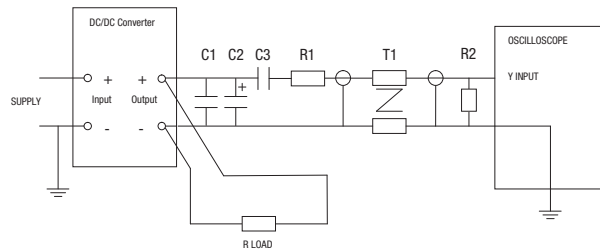

APPLICATION NOTES

Minimum load

The minimum load to meet datasheet specification is 10% of the full rated load across the specified input voltage range. Lower than 10% minimum loading will result in an increase in output voltage, which may rise to typically double the specified output voltage if the output load falls to less than 5%.

Capacitive loading and start up

Typical start up times for this series, with a typical input voltage rise time of 2.2µs and output capacitance of 10µF, are shown in the table below. The product series will start into a capacitance of 47µF with an increased start time, however, the maximum recommended output capacitance is 10µF.

	Start-up time ms		Start-up time ms
NKA0303SC	1.35	NKA0509SC	8.01
NKA0305SC	3.35	NKA0512SC	14.63
NKA0309SC	9.30	NKA0515SC	28.38
NKA0312SC	22.13	NKA1205SC	2.11
NKA0315SC	25.04	NKA1209SC	7.62
NKA0503SC	0.80	NKA1212SC	9.08
NKA0505SC	2.32	NKA1215SC	14.39
NKA0505SEC	2.03		

Typical Start-Up Wave Form

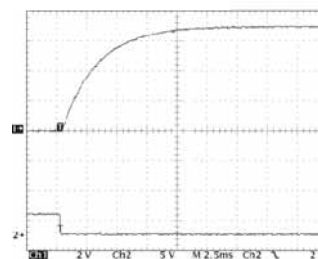

APPLICATION NOTES (Continued)

Output Ripple Reduction

By using the values of inductance and capacitance stated, the output ripple at the rated load is lowered to 5mV p-p max.

Component selection

Capacitor: It is required that the ESR (Equivalent Series Resistance) should be as low as possible, ceramic types are recommended. The voltage rating should be at least twice (except for 15V output), the rated output voltage of the DC-DC converter.

Inductor: The rated current of the inductor should not be less than that of the output of the DC-DC converter. At the rated current, the DC resistance of the inductor should be such that the voltage drop across the inductor is <2% of the rated voltage of the DC-DC converter. The SRF (Self Resonant Frequency) should be >20MHz.

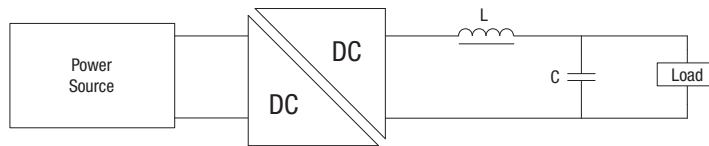

	Inductor			Capacitor
	L, μ H	SMD	Through Hole	C, μ F
NKA0303xC	10	82103C	11R103C	1 μ F
NKA0305xC	22	82223C	11R223C	2.2 μ F
NKA0309xC	47	82473C	11R473C	2.2 μ F
NKA0312xC	68	82683C	11R683C	3.3 μ F
NKA0315xC	470	82474C	11R474C	2.2 μ F
NKA0503xC	10	82103C	11R103C	1 μ F
NKA0505xC	22	82223C	11R223C	2.2 μ F
NKA0505xEC	22	82223C	11R223C	2.2 μ F
NKA0509xC	47	82473C	11R473C	2.2 μ F
NKA0512xC	150	82154C	11R154C	0.33 μ F
NKA0515xC	470	82474C	11R474C	2.2 μ F
NKA1205xC	22	82223C	11R223C	2.2 μ F
NKA1209xC	47	82473C	11R473C	2.2 μ F
NKA1212xC	150	82154C	11R154C	0.33 μ F
NKA1215xC	470	82474C	11R474C	2.2 μ F

TOLERANCE ENVELOPES

The voltage tolerance envelope shows typical load regulation characteristics for this product series. The tolerance envelope is the maximum output voltage variation due to changes in output loading.

3.3V output types

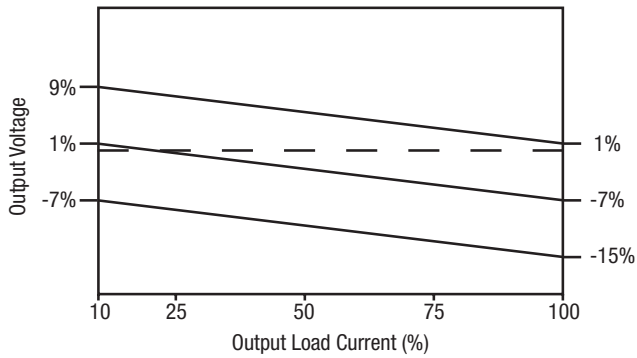

All other types

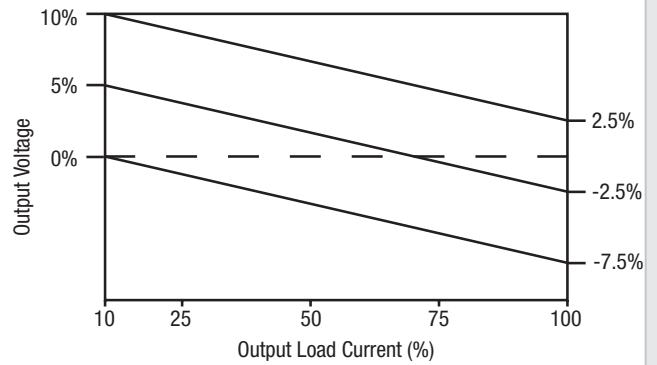

TEMPERATURE DERATING GRAPHS

NKA0303DC/SC, 0305DC/SC
0309DC/SC, 0505DEC/SEC
types only.

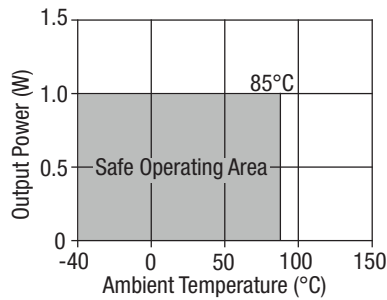

All other types.

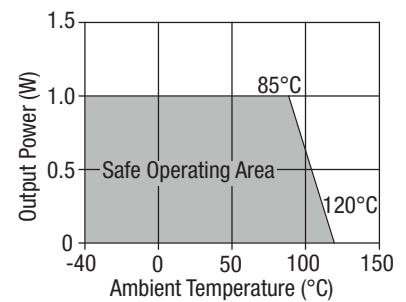

PACKAGE SPECIFICATIONS

MECHANICAL DIMENSIONS

SIP package

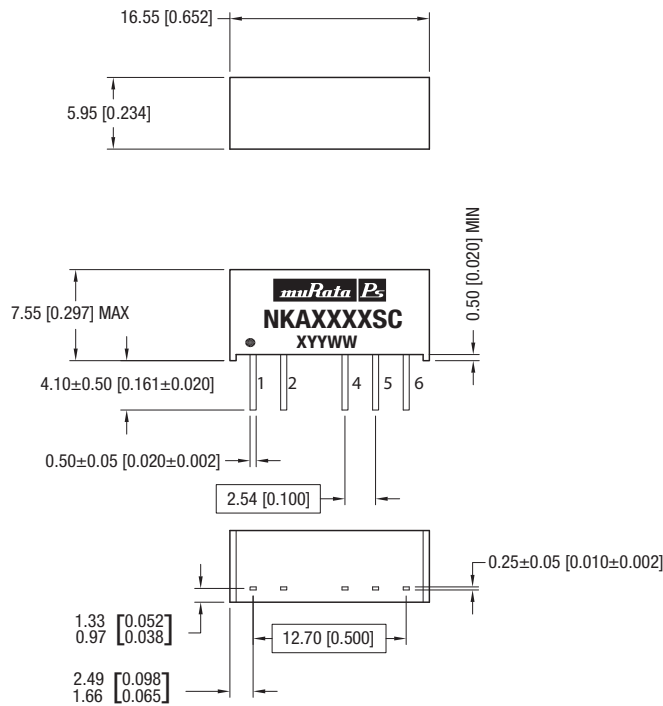

DIP package

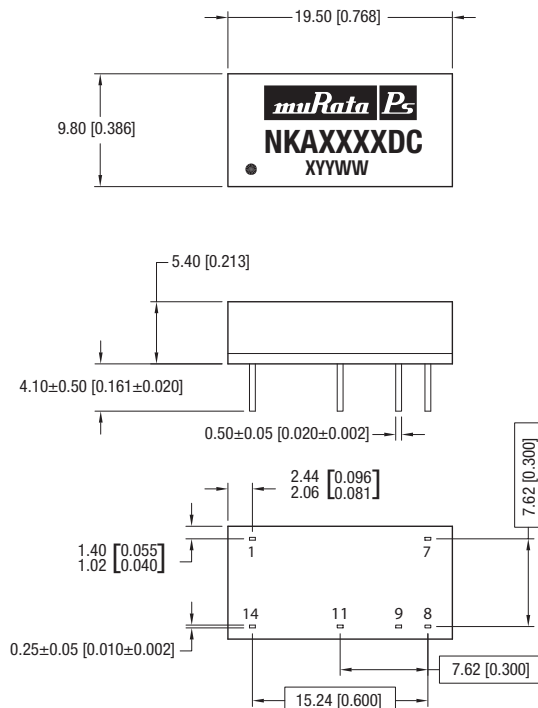

Controlling dimension is mm.

Unless otherwise stated all dimensions in mm (inches) ±0.25mm (0.010).

All pins on a 2.54mm (0.100") pitch and within 0.25mm (0.010") of true position.

Weight: 1.4g (SIP) 1.9g (DIP)

PIN CONNECTIONS - 14 PIN DIP

Pin	Function
1	-VIN
7	NC
8	OV
9	+VOUT
11	-VOUT
14	+VIN

PIN CONNECTIONS - 6 PIN SIP

Pin	Function
1	+VIN
2	-VIN
4	-VOUT
5	OV
6	+VOUT

PACKAGE SPECIFICATIONS (Continued)

RECOMMENDED FOOTPRINT DETAILS

14 Pin DIP Package

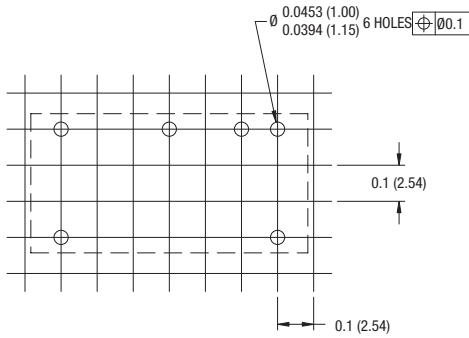

6 Pin SIP Package

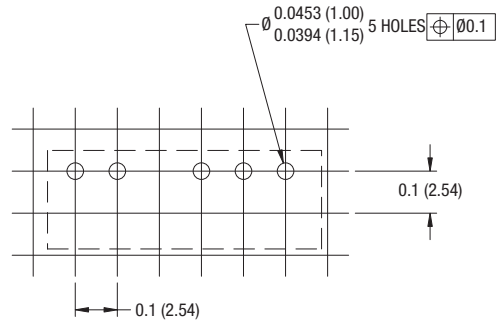

TUBE OUTLINE DIMENSIONS

14 Pin DIP Tube

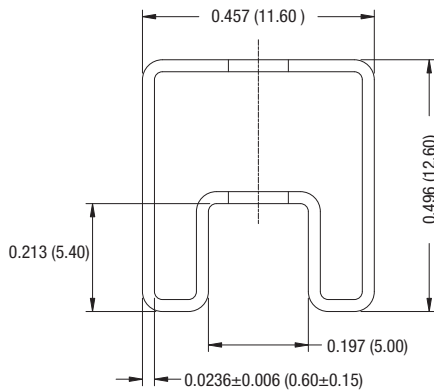

6 Pin SIP Tube

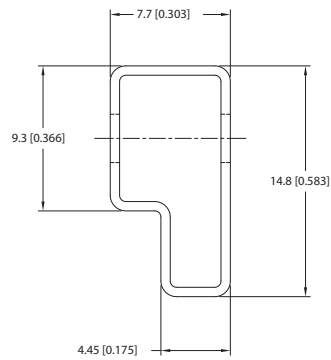

Unless otherwise specified all dimensions in mm [inches] \pm 0.55mm [0.022].
 Tube length (14 Pin DIP) : 520mm \pm 2mm [20.47].
 Tube length (6 Pin SIP) : 525mm [20.669] \pm 2.0 [0.079].

DIP Tube Quantity : 25
 SIP Tube Quantity : 30

DISCLAIMER

Unless otherwise stated in the datasheet, all products are designed for standard commercial and industrial applications and NOT for safety-critical and/or life-critical applications.

Particularly for safety-critical and/or life-critical applications, i.e. applications that may directly endanger or cause the loss of life, inflict bodily harm and/or loss or severe damage to equipment/property, and severely harm the environment, a prior explicit written approval from Murata is strictly required. Any use of Murata standard products for any safety-critical, life-critical or any related applications without any prior explicit written approval from Murata shall be deemed unauthorised use.

These applications include but are not limited to:

- Aircraft equipment
- Aerospace equipment
- Undersea equipment
- Power plant control equipment
- Medical equipment
- Transportation equipment (automobiles, trains, ships, etc.)
- Traffic signal equipment
- Disaster prevention / crime prevention equipment
- Data Processing equipment

Murata makes no express or implied warranty, representation, or guarantee of suitability, fitness for any particular use/purpose and/or compatibility with any application or device of the buyer, nor does Murata assume any liability whatsoever arising out of unauthorised use of any Murata product for the application of the buyer. The suitability, fitness for any particular use/purpose and/or compatibility of Murata product with any application or device of the buyer remain to be the responsibility and liability of the buyer.

Buyer represents and agrees that it has all the necessary expertise to create and implement safeguards that anticipate dangerous consequences of failures, monitor failures and their consequences, lessen the likelihood of failures that might cause harm, and take appropriate remedial actions. Buyer will fully indemnify and hold Murata, its affiliated companies, and its representatives harmless against any damages arising out of unauthorised use of any Murata products in any safety-critical and/or life-critical applications.

Remark: Murata in this section refers to Murata Manufacturing Company and its affiliated companies worldwide including, but not limited to, Murata Power Solutions.



This product is subject to the following [operating requirements](https://www.murata.com/en-eu/products/power/requirements) and the [Life and Safety Critical Application Sales Policy](https://www.murata.com/en-eu/products/power/requirements):

Refer to: <https://www.murata.com/en-eu/products/power/requirements>

Murata Power Solutions (Milton Keynes) Ltd., makes no representation that the use of its products in the circuits described herein, or the use of other technical information contained herein, will not infringe upon existing or future patent rights. The descriptions contained herein do not imply the granting of licenses to make, use, or sell equipment constructed in accordance therewith. Specifications are subject to change without notice.
© 2021 Murata Power Solutions (Milton Keynes) Ltd.