

FEATURES

- Small footprint DC/DC converter, ideal for high current applications
- Tiny 0.9" x 1.3" x 0.40" open frame package
- Industry standard DOSA "brick" format and pinout with surface mount option
- 36-75 Volts DC input range
- 2250 Volt Basic input/output isolation (48V models)
- Up to 66 Watts total output power with overtemperature shutdown
- High efficiency synchronous rectifier forward topology
- Stable no-load operation with no required external components
- Operating temperature range -40 to +85°C with derating
- Certified to UL 60950-1, CSA-C22.2 No. 234, safety approvals, 2nd Edition, IEC 62368
- Extensive self-protection shut down features

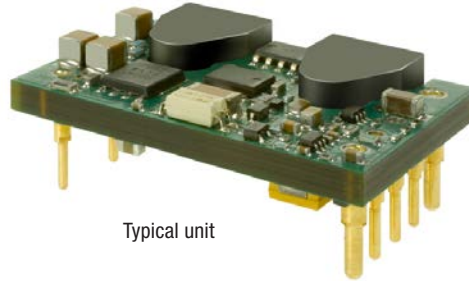

PRODUCT OVERVIEW

The world of "brick" DC/DC converters has seen a steady size reduction. The ULS series makes another dramatic size shrink down to a "sixteenth-brick" width (0.9 inches) while still retaining up to 66 Watt output and full 2250 Volt DC isolation. The PC-board mount converter family accepts 36 to 75 Volts DC inputs and delivers fixed outputs regulated to within $\pm 0.2\%$. The ULS converters are ideal for datacom and telecom applications, cell phone towers, data centers, server farms and network repeaters.

ULS outputs may be trimmed within $\pm 10\%$ of nominal output while delivering fast settling to current step loads and no adverse effects from higher capacitive loads. Excellent ripple and noise specifications assure compatibility to circuits using CPU's, ASIC's, programmable logic and FPGA's. No

minimum load is required. For systems requiring controlled startup/shutdown, an external remote On/Off control may use a switch, transistor or digital logic. Remote Sense inputs compensate for resistive line drops at high currents.

Many self-protection features on the ULS series avoid both converter and external circuit hazards. These include input undervoltage lockout and overtemperature shutdown. The outputs current limit using the "hiccup" autorestart technique and the outputs may be short-circuited indefinitely. Additional features include output overvoltage and reverse conduction elimination.

The synchronous rectifier forward topology yields high efficiency for minimal heat buildup and "no fan" operation.

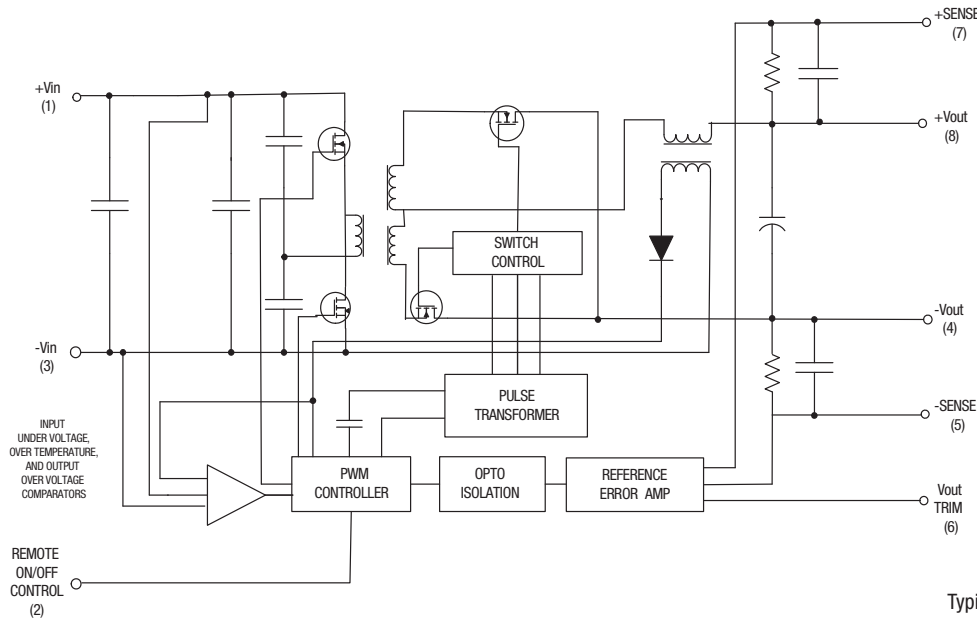

Typical topology is shown



PERFORMANCE SPECIFICATIONS SUMMARY AND ORDERING GUIDE ①														
Root Model ①	Output						Input				Efficiency		C76 Package	
	V _{OUT} (V)	I _{OUT} (A, max.)	Power (W)	R/N (mV pk-pk) ②		Regulation (max.) ③		V _{IN} Nom. (V)	Range (V)	I _{IN} , no load (mA)	I _{IN} , full load (A)	Min.	Typ.	Case (inches)
				Typ.	Max.	Line	Load							
ULS-3.3/20-D48N-C	3.3	20	66	70	120	±0.1%	±0.2%	48	36-75	20	1.53	89%	90%	0.9x1.3x0.40
ULS-5/12-D48N-C	5	12	60	50	80	±0.125%	±0.25%	48	36-75	40	1.39	88%	90%	0.9x1.3x0.40
ULS-12/5-D48N-C	12	5	60	80	120	±0.125%	±0.25%	48	36-75	50	1.37	88%	91%	0.9x1.3x0.40

- ① Please refer to the Part Number Structure when ordering.
- ② These specifications are preliminary. Contact Murata Power Solutions for availability.
- ③ All specifications are at nominal line voltage and full load, +25°C unless otherwise noted. See detailed specifications. Output capacitors are 1 µF ceramic multilayer in parallel with 10 µF electrolytic. I/O caps are necessary for our test equipment and may not be needed for your application.
- ④ Regulation specifications describe output voltage deviations from a nominal/midpoint value to either extreme (50% load step).

PART NUMBER STRUCTURE

ULS - 3.3 / 20 - D48 N M H Lx - C Refer to [back page](#) for model specific availability

- Sixteenth Brick Series**
- Nominal Output Voltage:** 3.3V, 5V, 12V
- Maximum Rated Output Current Current in Amps**: 20A, 12A, 5A
- Input Voltage Range:** D48 = 36-75 Volts (48V nominal)
- RoHS Hazardous Substance Compliance** (does not claim EU RoHS exemption 7b—lead in solder)
 - C = RoHS-6
 - Y = RoHS-5
- Pin Length Option (Thru-hole only)**
 - Blank = Standard pin length 0.180" (4.6mm)
 - L1 = 0.110" (2.79mm) ①
 - L2 = 0.145" (3.68mm) ①
- Conformal Coating:**
 - Blank = No coating, standard
 - H = Coating added, optional special order* (not available on SMT models)
- SMT Version**
 - Blank = Through-hole mount, no SMT ②
 - M = Surface mount (MSL = 3)
- On/Off Control Logic:**
 - N = Negative
 - P = Positive

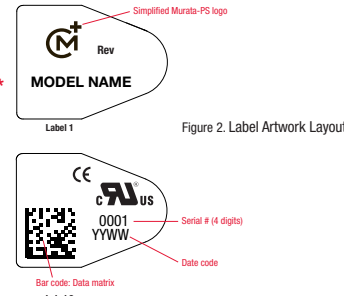

Figure 2. Label Artwork Layout

- ① **Special quantity order is required; samples available with standard pin length only.**
- ② **SMT (M) versions not available in sample quantities.**
- ③ **Some model number combinations may not be available. See website or contact your local Murata sales representative.**

Product Label

As shown in figure 2, because of the small size of these products, the product labels contain a simplified Murata-PS logo and a character-reduced code to indicate the model number and manufacturing date code. Not all items on the label are always used. Please note that the label differs from the product photograph.

FUNCTIONAL SPECIFICATIONS, ULS-3.3/20-D48

ABSOLUTE MAXIMUM RATINGS	Conditions ①	Minimum	Typical/Nominal	Maximum	Units
Input Voltage, Continuous	Full power operation			80	Vdc
Input Voltage, Transient	Operating or non-operating, tested: 100 mS max. duration			100	Vdc
Isolation Voltage	Input to output			2250	Vdc
Input Reverse Polarity	None, install external fuse		None		Vdc
On/Off Remote Control	Power on, referred to -Vin	0		15	Vdc
Output Power		0		66.66	W
Output Current	Current-limited, no damage, short-circuit protected	0		20	A
Storage Temperature Range	Vin = Zero (no power)	-55		125	°C

Absolute maximums are stress ratings. Exposure of devices to greater than any of these conditions may adversely affect long-term reliability. Proper operation under conditions other than those listed in the Performance/Functional Specifications Table is not implied or recommended.

INPUT					
Operating voltage range		36	48	75	Vdc
Recommended External Fuse	Fast blow			4	A
Start-up threshold, turn on	Rising input voltage	33.5	34.5	35.5	Vdc
Undervoltage shutdown, turn off ②	Falling input voltage	31.5	32.5	33.5	Vdc
Oversvoltage protection			NA		Vdc
Reverse Polarity Protection	None, install external fuse		None		Vdc
Internal Filter Type			Capacitive		
Input current					
Full Load Conditions	Vin = nominal		1.53	1.56	A
Low Line	Vin = minimum		2.08	2.15	A
Inrush Transient			0.05		A2-Sec.
Output in Short Circuit			150	300	mA
No Load input current	Iout = minimum, unit=ON		30	100	mA
Shut-Down Mode Input Current			5	15	mA
Reflected (back) ripple current ②	no filtering		150	210	mAp-p
Reflected (back) ripple current ②	Measured at input with specified filter		20	30	mAp-p

GENERAL and SAFETY					
Efficiency	Vin=48V, full load	89	90		%
	Vin=Min	86	88		%
Isolation					
Isolation Voltage, input to output				2250	Vdc
Insulation Safety Rating			basic		
Isolation Resistance			100		MΩ
Isolation Capacitance			1000		pF
Safety (meets the following requirements)	UL-60950-1, CSA-C22.2 No.60950-1, IEC60950-1, 2nd Edition, IEC62368		Yes		
Calculated MTBF	Per MIL-HDBK-217F, ground benign, Tambient=+40°C		TBD		Hours x 10 ³
Calculated MTBF ④	Per Telcordia SR332, issue 1, class 3, ground fixed, Tambient=+40°C		3200		Hours x 10 ³

DYNAMIC CHARACTERISTICS					
Fixed Switching Frequency ⑬		480	500	520	KHz
Startup Time	Power on, Vout regulated		5	15	mS
Startup Time	Remote ON to Vout regulated		5	10	mS
Dynamic Load Response	50-75-50% load step, settling time to within 1% of Vout.		50	150	μSec
Dynamic Load Peak Deviation	same as above		±150	±200	mV

FEATURES and OPTIONS					
Remote On/Off Control					
"N" suffix:					
Negative Logic, ON state	ON = Pin grounded or external voltage	-0.1		0.8	V
Negative Logic, OFF state	OFF = Pin open or external voltage	2.5		15	V
Control Current	open collector/drain		1	2	mA

FUNCTIONAL SPECIFICATIONS, ULS-3.3/20-D48 (CONT.)

FEATURES and OPTIONS (cont.)	Conditions ①	Minimum	Typical/Nominal	Maximum	Units
Remote On/Off Control (cont.)					
"P" suffix:					
Positive Logic, ON state	ON = Pin open or external voltage	3.5		15	V
Positive Logic, OFF state	OFF = Ground pin or external voltage	0		1	V
Control Current	open collector/drain		1	2	mA
OUTPUT					
Total Output Power		0	66	66.66	W
Voltage					
Nominal Output Voltage ③⑮	No trim	3.267	3.3	3.333	Vdc
Settling Accuracy	At 50% load	-1		1	% of Vset
Output Voltage Range ⑧	User-adjustable	-10		10	
Overvoltage Protection	Via magnetic feedback	3.75	4.25	4.95	Vdc
Remote Sense Compensation	Of Vset ⑱		10		%
Current					
Output Current Range		0	20	20	A
Minimum Load			No minimum load		
Current Limit Inception ⑳	98% of Vnom., cold condition	22	26	30	A
Short Circuit ㉑					
Short Circuit Current	Hiccup technique, autorecovery within ±1% of Vout		6.6		A
Short Circuit Duration (remove short for recovery)	Output shorted to ground, no damage		Continuous		
Short circuit protection method	Hiccup current limiting				
Regulation					
Line Regulation ㉒	Vin=min. to max., Vout=nom., nom load		±0.1		V
Load Regulation ㉒	Iout=min. to max		±0.2		V
Ripple and Noise	5 Hz- 20 MHz BW		70	120	mV pk-pk
Temperature Coefficient	At all outputs		0.02		% of Vout./°C
Maximum Capacitive Loading (10% ceramic, 90% Oscon)	Low ESR, .02 ohms max (resistive load)		1000		µF
MECHANICAL (Through Hole Models)					
Outline Dimensions	Cxx case		1.3x0.9x0.4		Inches
(Please refer to outline drawing)	WxLxH		33x22.9x10.2		mm
Weight			0.58		Ounces
			16.4		Grams
Through Hole Pin Diameter			.062 & .04		Inches
			1.575 & 1.016		mm
Through Hole Pin Material			Gold-plated copper alloy with nickel underplate		
TH Pin Plating Metal and Thickness	Nickel subplate		50		µ-inches
	Gold overplate		5		µ-inches
ENVIRONMENTAL					
Operating Ambient Temperature Range ㉓	No derating, full power, 200 LFM, no condensation	-40		85	°C
Storage Temperature	Vin = Zero (no power)	-55		125	°C
Operating Case Temp	No derating required	-40		120	°C
Thermal Protection/Shutdown	Measured at hotspot	110	115	120	°C
Electromagnetic Interference	External filter is required				
Conducted, EN55022/CISPR22			B		Class
Radiated, EN55022/CISPR22			B		Class
RoHS rating			RoHS		

TYPICAL PERFORMANCE DATA, ULS-3.3/20-D48

Efficiency vs. Line Voltage and Load Current @ 25°C

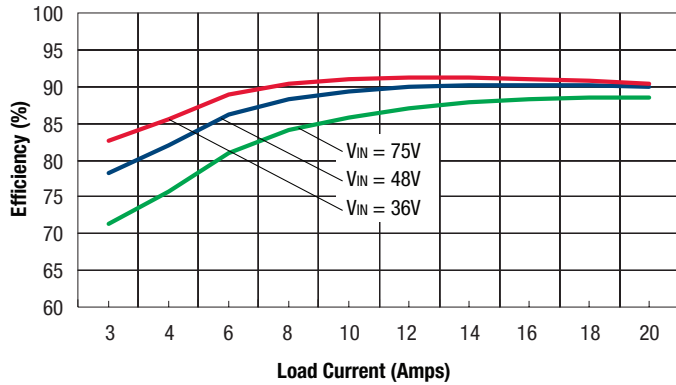

Maximum Current Temperature Derating at Sea Level
(VIN = 48V, longitudinal airflow)

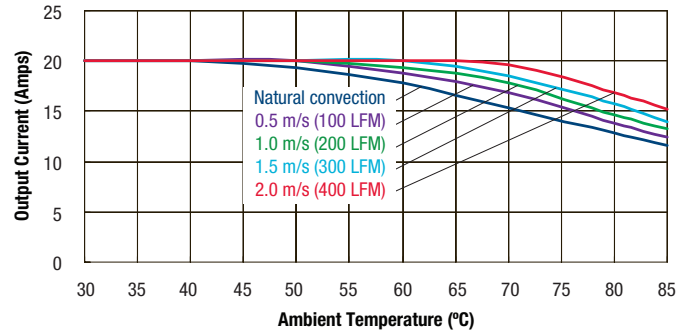

(Resistive loads 50% with +25% step Vin=48V)

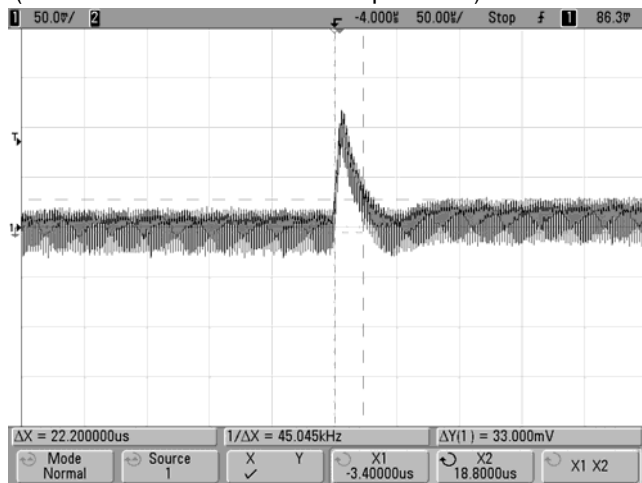

Transient Response (Load from 75% to 50%)

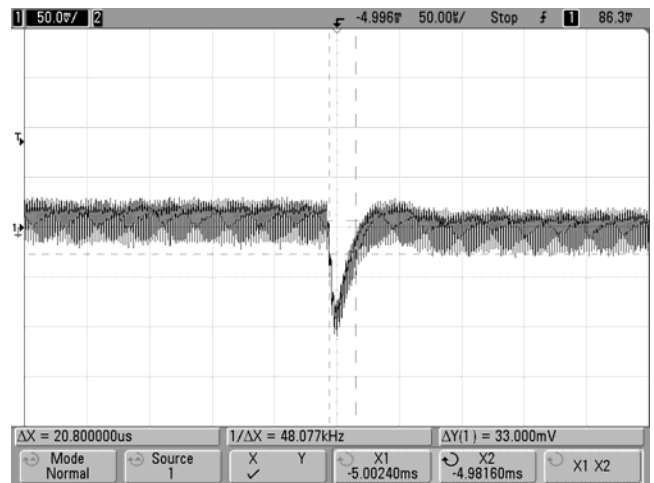

Transient Response (Load from 50% to 75%)

Enable Start-up

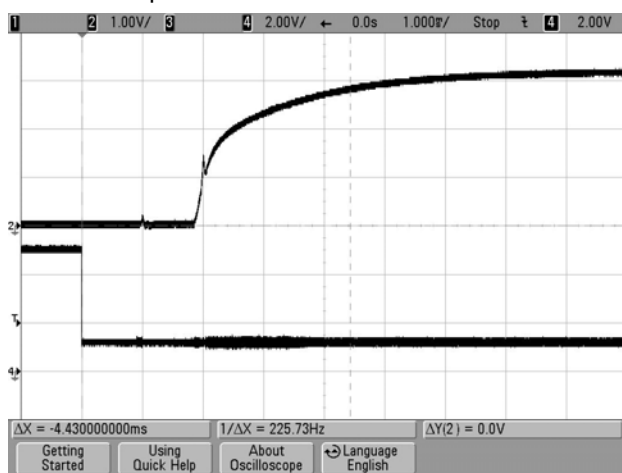

Enable Start-up (Vin=48V Iout=20A)



Enable Start-up (Vin=48V Iout=0A)

TYPICAL PERFORMANCE DATA, ULS-3.3/20-D48 (CONT.)

Ripple and Noise (1uF Ceramic and 10uF Tantalum Capacitors)

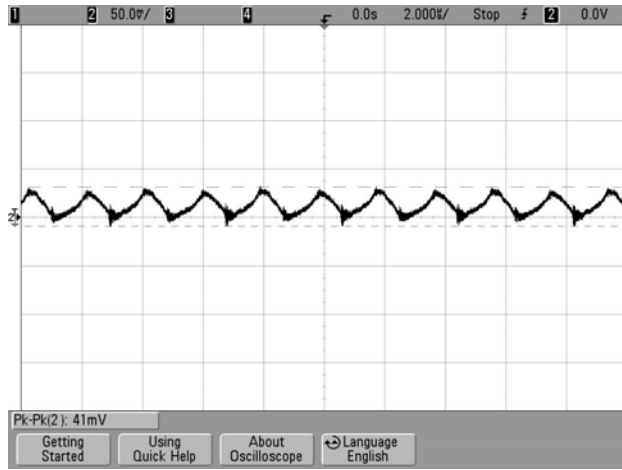

R/N Waveform (Vin=48V Iout=20A)

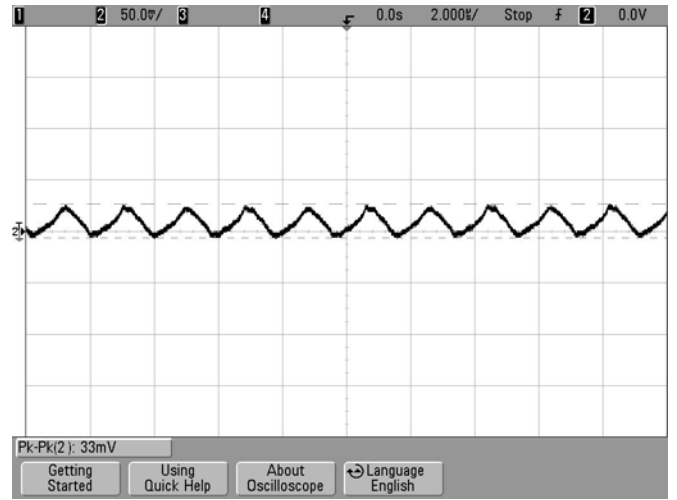

R/N Waveform (Vin=48V Iout=0A)

FUNCTIONAL SPECIFICATIONS, ULS-5/12-D48

ABSOLUTE MAXIMUM RATINGS	Conditions ①	Minimum	Typical/Nominal	Maximum	Units
Input Voltage, Continuous	Full power operation			80	Vdc
Input Voltage, Transient	Operating or non-operating, tested: 100 mS max. duration			100	Vdc
Isolation Voltage	Input to output			2250	Vdc
Input Reverse Polarity	None, install external fuse		None		Vdc
On/Off Remote Control	Power on, referred to -Vin	0		15	Vdc
Output Power		0		60.6	W
Output Current	Current-limited, no damage, short-circuit protected	0		12	A
Storage Temperature Range	Vin = Zero (no power)	-55		125	°C
Absolute maximums are stress ratings. Exposure of devices to greater than any of these conditions may adversely affect long-term reliability. Proper operation under conditions other than those listed in the Performance/Functional Specifications Table is not implied or recommended.					
INPUT					
Operating voltage range		36	48	75	Vdc
Recommended External Fuse	Fast blow			4	A
Start-up threshold, turn on	Rising input voltage	33	34.5	35.5	Vdc
Undervoltage shutdown, turn off ②	Falling input voltage	31	32.5	33.5	Vdc
Oversvoltage protection			NA		Vdc
Reverse Polarity Protection	None, install external fuse		None		Vdc
Internal Filter Type			LC		
Input current					
Full Load Conditions	Vin = nominal		1.39	1.43	A
Low Line	Vin = minimum		1.85	1.91	A
Inrush Transient			0.05		A2-Sec.
Output in Short Circuit			100	200	mA
No Load input current	Iout = minimum, unit=ON		40	80	mA
Shut-Down Mode Input Current			5	10	mA
Reflected (back) ripple current ②	no filtering		400	500	mAp-p
Reflected (back) ripple current ②	Measured at input with specified filter		25	35	mAp-p
GENERAL and SAFETY					
Efficiency	Vin=48V, full load	88	90		%
	Vin=Min	88	90		%
Isolation					
Isolation Voltage, input to output				2250	Vdc
Insulation Safety Rating			basic		
Isolation Resistance			10		MΩ
Isolation Capacitance			1000		pF
Safety (meets the following requirements)	UL-60950-1, CSA-C22.2 No.60950-1, IEC60950-1, 2nd Edition, IEC62368		Yes		
Calculated MTBF	Per MIL-HDBK-217F, ground benign, Tambient=+40°C		TBD		Hours x 10 ³
Calculated MTBF ④	Per Telcordia SR332, issue 1, class 3, ground fixed, Tambient=+40°C		3200		Hours x 10 ³
DYNAMIC CHARACTERISTICS					
Fixed Switching Frequency ⑩			400		KHz
Startup Time	Power on, Vout regulated		10	20	mS
Startup Time	Remote ON to Vout regulated		10	20	mS
Dynamic Load Response	50-75-50% load step, settling time to within 1% of Vout.		50	100	μSec
Dynamic Load Peak Deviation	same as above		±200	±250	mV
FEATURES and OPTIONS					
Remote On/Off Control					
"N" suffix:					
Negative Logic, ON state	ON = Pin grounded or external voltage	-0.1		0.8	V
Negative Logic, OFF state	OFF = Pin open or external voltage	2.5		15	V
Control Current	open collector/drain		1	2	mA

FUNCTIONAL SPECIFICATIONS, ULS-5/12-D48 (CONT.)

FEATURES and OPTIONS (cont.)	Conditions ①	Minimum	Typical/Nominal	Maximum	Units
Remote On/Off Control (cont.)					
"P" suffix:					
Positive Logic, ON state	ON = Pin open or external voltage	3.5		15	V
Positive Logic, OFF state	OFF = Ground pin or external voltage	0		1	V
Control Current	open collector/drain		1	2	mA
OUTPUT					
Total Output Power		0	60	60.6	W
Voltage					
Nominal Output Voltage ③⑮	No trim	4.95	5	5.05	Vdc
Settling Accuracy	At 50% load	-1		1	% of Vset
Output Voltage Range ⑧	User-adjustable	-10		10	
Overvoltage Protection	Via magnetic feedback	6	6.5	7.2	Vdc
Remote Sense Compensation	Of Vset ⑱		10		%
Current					
Output Current Range		0	12	12	A
Minimum Load			No minimum load		
Current Limit Inception ⑳	98% of Vnom., after warm up	14	16	19	A
Short Circuit ㉑					
Short Circuit Current	Hiccup technique, autorecovery within ±1% of Vout		0.5	1	A
Short Circuit Duration (remove short for recovery)	Output shorted to ground, no damage		Continuous		
Short circuit protection method	Hiccup current limiting				
Regulation					
Line Regulation ㉒	Vin=min. to max., Vout=nom., nom load		±0.125		V
Load Regulation ㉒	Iout=min. to max		±0.25		V
Ripple and Noise	5 Hz- 20 MHz BW		50	100	mV pk-pk
Temperature Coefficient	At all outputs		0.02		% of Vout./°C
Maximum Capacitive Loading (10% ceramic, 90% Oscon)	Low ESR, .02 ohms max (resistive load)		220	1000	µF
MECHANICAL (Through Hole Models)					
Outline Dimensions	Cxx case		1.3x0.9x0.4		Inches
(Please refer to outline drawing)	WxLxH		33x22.9x10.2		mm
Weight			0.58		Ounces
			16.4		Grams
Through Hole Pin Diameter			.062 & .04		Inches
			1.575 & 1.016		mm
Through Hole Pin Material			Gold-plated copper alloy with nickel underplate		
TH Pin Plating Metal and Thickness	Nickel subplate		50		µ-inches
	Gold overplate		5		µ-inches
ENVIRONMENTAL					
Operating Ambient Temperature Range ㉓	No derating, full power, 200 LFM, no condensation	-40		85	°C
Storage Temperature	Vin = Zero (no power)	-55		125	°C
Operating Case Temp	No derating required	-40		120	°C
Thermal Protection/Shutdown	Measured at hotspot	110	115	130	°C
Electromagnetic Interference	External filter is required				
Conducted, EN55022/CISPR22			A		Class
Radiated, EN55022/CISPR22			A		Class
RoHS rating			RoHS		

TYPICAL PERFORMANCE DATA, ULS-5/12-D48

Efficiency and Power Dissipation @ 25°C

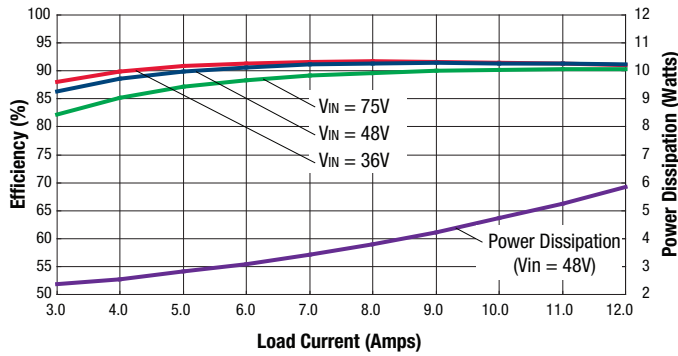

Maximum Current Temperature Derating at Sea Level
(VIN = 48V, airflow is from Vin to Vout)

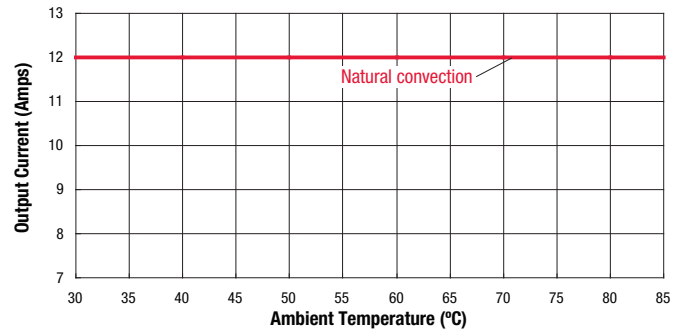

Enable Start-up (VIN=48V, Iout=12A, Ta=+25°C) Trace 2=Output, Trace 4= Enable.

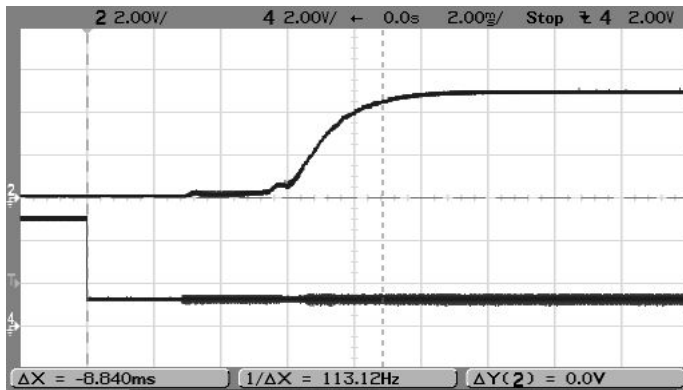

Enable Start-up (VIN=48V, Iout=0A, Ta=+25°C) Trace 2=Output, Trace 4= Enable.

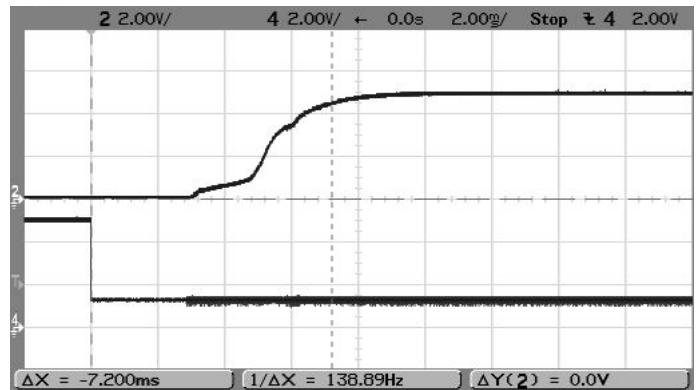

Enable Start-up (VIN=48V, Iout=12A, Cload=1000µF, Ta=+25°C)
Trace 2=Output, Trace 4= Enable.

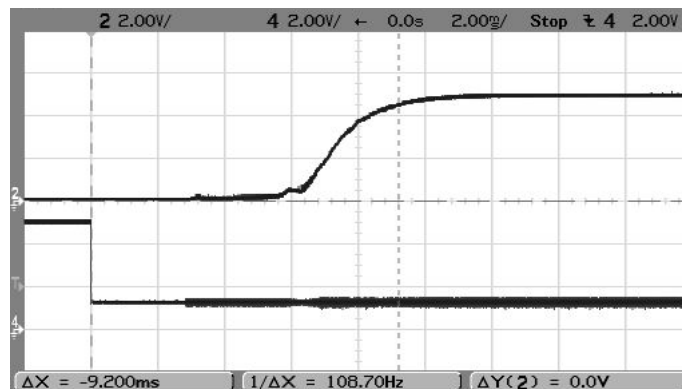

TYPICAL PERFORMANCE DATA, ULS-5/12-D48 (CONT.)

Output and Ripple Noise (Vin=48V, Iout=12A, 1uF Ceramic and 10uF tantalum capacitors)

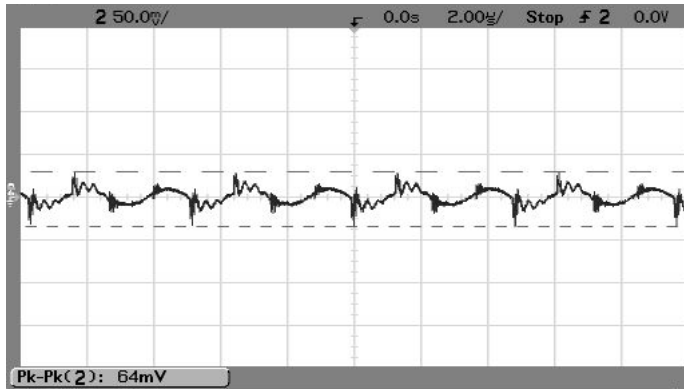

Output and Ripple Noise (Vin=48V, Iout=0A, 1uF Ceramic and 10uF tantalum capacitors)

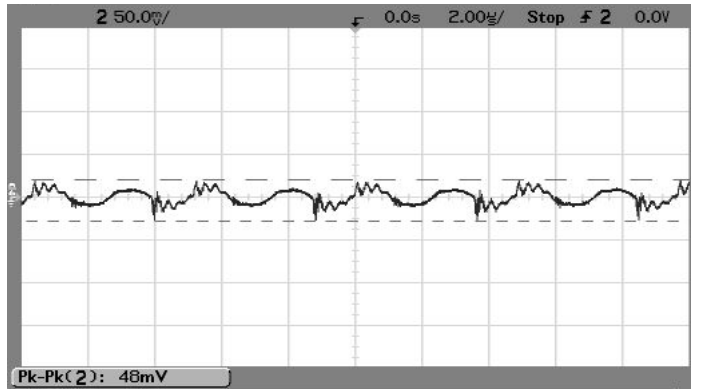

Transient Response (Vin=48V, Iout=50-75-50% of Imax)
(Recovery time=9.6uS)

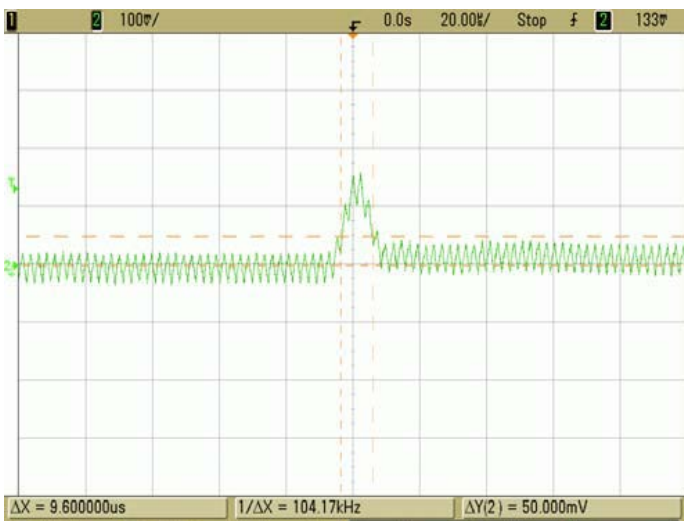

Transient Response (Vin=48V, Iout=50-75-50% of Imax)
(Recovery time=10uS)

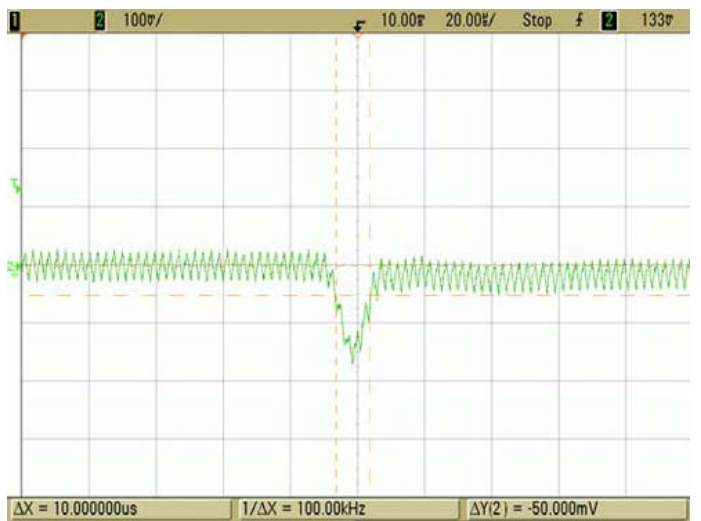

Transient Response (Vin=48V, Iout=50-75-50% of Imax)

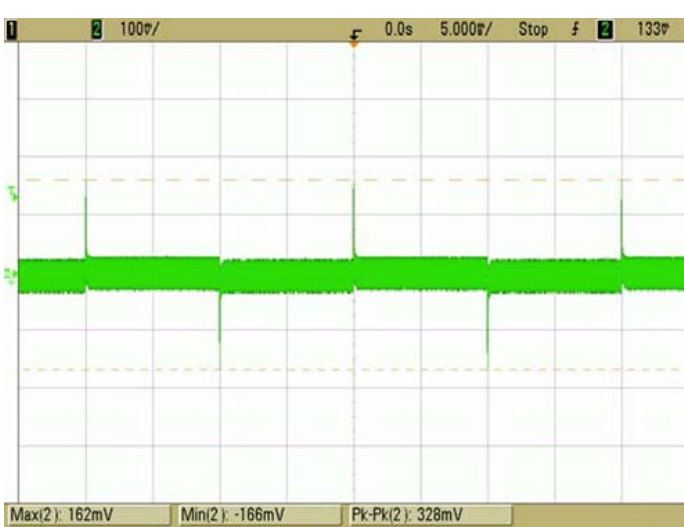

Thermal image with hot spot at full load with 85 °C ambient; air is flowing at 400LFM. Air if flowing across the converter from +V to -V at 48V input. Identifiable and recommended value to be verified in application. (Q2, max temp=120 °C/IPC9592 guidelines)

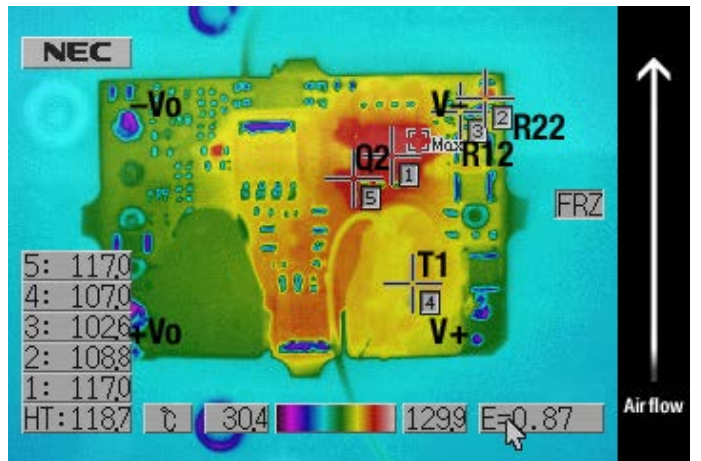

FUNCTIONAL SPECIFICATIONS, ULS-12/5-D48*

ABSOLUTE MAXIMUM RATINGS	Conditions ①	Minimum	Typical/Nominal	Maximum	Units
Input Voltage, Continuous	Full power operation			80	Vdc
Input Voltage, Transient	Operating or non-operating, tested: 100 mS max. duration			100	Vdc
Isolation Voltage	Input to output			2250	Vdc
Input Reverse Polarity	None, install external fuse		None		Vdc
On/Off Remote Control	Power on, referred to -Vin	0		15	Vdc
Output Power		0		60.6	W
Output Current	Current-limited, no damage, short-circuit protected	0		5	A
Storage Temperature Range	Vin = Zero (no power)	-55		125	°C

Absolute maximums are stress ratings. Exposure of devices to greater than any of these conditions may adversely affect long-term reliability. Proper operation under conditions other than those listed in the Performance/Functional Specifications Table is not implied or recommended.

INPUT					
Operating voltage range		36	48	75	Vdc
Recommended External Fuse	Fast blow			4	A
Start-up threshold, turn on	Rising input voltage	33	34.5	35.5	Vdc
Undervoltage shutdown, turn off ②	Falling input voltage	31	32.5	33.5	Vdc
Oversvoltage protection			NA		Vdc
Reverse Polarity Protection	None, install external fuse		None		Vdc
Internal Filter Type			Capacitance		
Input current					
Full Load Conditions	Vin = nominal		1.37	1.43	A
Low Line	Vin = minimum		1.83	1.89	A
Inrush Transient			0.05		A2-Sec.
Output in Short Circuit			100	200	mA
No Load input current	Iout = minimum, unit=ON		50	150	mA
Shut-Down Mode Input Current (TH)			15	25	mA
Shut-Down Mode Input Current (SMT)			15	20	mA
Reflected (back) ripple current ②	no filtering		150	200	mAp-p
Reflected (back) ripple current ②	Measured at input with specified filter		15	30	mAp-p
GENERAL and SAFETY					
Efficiency	Vin=48V, full load	88	91		%
	Vin=Min (TH)	89	90		%
	Vin=Min (SMT)	89	91.5		%
Isolation					
Isolation Voltage, input to output				2250	Vdc
Insulation Safety Rating			basic		
Isolation Resistance			100		MΩ
Isolation Capacitance (TH)			1000		pF
Isolation Capacitance (SMT)			1500		pF
Safety (meets the following requirements)	UL-60950-1, CSA-C22.2 No.60950-1, IEC60950-1, 2nd Edition; IEC62368		Yes		
Calculated MTBF	Per MIL-HDBK-217F, ground benign, Tambient=+40°C		TBD		Hours x 10 ³
Calculated MTBF ④	Per Telcordia SR332, issue 1, class 3, ground fixed, Tambient=+40°C		3200		Hours x 10 ³
DYNAMIC CHARACTERISTICS					
Fixed Switching Frequency ⑬		470	520	570	KHz
Startup Time	Power on, Vout regulated			30	mS
Startup Time (TH)	Remote ON to Vout regulated			30	mS
Startup Time (SMT)	Remote ON to Vout regulated			20	mS
Dynamic Load Response	50-75-50% load step, settling time to within 1% of Vout.		25	50	µSec
Dynamic Load Peak Deviation	same as above		±180	±240	mV

*NOTE: The ULS-12/5-D48NM-C (SMT version) contains ceramic capacitors. No tantalum capacitors are used.

FUNCTIONAL SPECIFICATIONS, ULS-12/5-D48 (CONT.)

FEATURES and OPTIONS	Conditions ①	Minimum	Typical/Nominal	Maximum	Units
Remote On/Off Control					
"N" suffix:					
Negative Logic, ON state	ON = Pin grounded or external voltage	-0.1		0.8	V
Negative Logic, OFF state	OFF = Pin open or external voltage	2.5		15	V
Control Current	open collector/drain		1	2	mA
"P" suffix:					
Positive Logic, ON state	ON = Pin open or external voltage	3.5		15	V
Positive Logic, OFF state	OFF = Ground pin or external voltage	0		1	V
Control Current	open collector/drain		1	2	mA
OUTPUT					
Total Output Power		0	60	60.6	W
Voltage					
Nominal Output Voltage ③ ⑮	No trim ⑯	11.88	12	12.12	Vdc
Settling Accuracy	At 50% load	-1		1	% of Vset
Output Voltage Range (TH) ⑥	User-adjustable	-10		10	
Output Voltage Range (SMT) ⑧	User-adjustable	-15		10	
Overvoltage Protection	Via magnetic feedback	13.3	14.5	18	Vdc
Remote Sense Compensation	Of Vset		10		%
Current					
Output Current Range		0	5	5	A
Minimum Load			No minimum load		
Current Limit Inception ③	98% of Vnom., after warm up	5.5	6.8	8	A
Short Circuit ⑤					
Short Circuit Current	Hiccup technique, autorecovery within ±1% of Vout		0.6		A
Short Circuit Duration (remove short for recovery)	Output shorted to ground, no damage		Continuous		
Short circuit protection method	Hiccup current limiting				
Regulation					
Line Regulation ⑦	Vin=min. to max., Vout=nom., nom load		±0.125		V
Load Regulation ⑦	Iout=min. to max		±0.25		V
Ripple and Noise	5 Hz- 20 MHz BW		80	120	mV pk-pk
Temperature Coefficient	At all outputs		0.02		% of Vout./°C
Maximum Capacitive Loading (10% ceramic, 90% Oscon)	Low ESR, .02 ohms max (resistive load)			2200	μF
Maximum Capacitive Loading	loads: CC mode				μF
MECHANICAL (Through Hole Models)					
Outline Dimensions	Cxx case		1.3x0.9x0.4		Inches
(Please refer to outline drawing)	WxLxH		33x22.9x10.2		mm
Weight			0.58		Ounces
			16.4		Grams
Through Hole Pin Diameter			.062 & .04		Inches
			1.575 & 1.016		mm
Through Hole Pin Material			Gold-plated copper alloy with nickel underplate		
TH Pin Plating Metal and Thickness	Nickel subplate		50		μ-inches
	Gold overplate		5		μ-inches
ENVIRONMENTAL					
Operating Ambient Temperature Range ⑩	No derating, full power, 200 LFM, no condensation	-40		85	°C
Storage Temperature	Vin = Zero (no power)	-55		125	°C
Operating Case Temp	No derating required	-40		105	°C
Thermal Protection/Shutdown	Measured at hotspot	115	125	130	°C
Electromagnetic Interference Conducted, EN55022/CISPR22	External filter is required		B		Class
Radiated, EN55022/CISPR22			B		Class
RoHS rating			RoHS		

Performance Specification Notes

- ① All specifications are typical unless noted. Ambient temperature = +25°Celsius, V_{IN} is nominal, output current is maximum rated nominal. External output capacitance is 1 μ F multilayer ceramic paralleled with 10 μ F electrolytic. All caps are low ESR. These capacitors are necessary for our test equipment and may not be needed in your application. Testing must be kept short enough that the converter does not appreciably heat up during testing. For extended testing, use plenty of airflow. See Derating Curves for temperature performance. All models are stable and regulate within spec without external capacitance.
- ② Input Ripple Current is tested and specified over a 5-20 MHz bandwidth and uses a special set of external filters only for the Ripple Current specifications. Input filtering is $C_{IN} = 33 \mu$ F, $C_{BUS} = 220 \mu$ F, $L_{BUS} = 12 \mu$ H. Use capacitor rated voltages which are twice the maximum expected voltage. Capacitors must accept high speed AC switching currents.
- ③ Note that Maximum Current Derating Curves indicate an average current at nominal input voltage. At higher temperatures and/or lower airflow, the converter will tolerate brief full current outputs if the average RMS current over time does not exceed the Derating curve. All Derating curves are presented at sea level altitude. Be aware of reduced power dissipation with increasing density altitude.
- ④ Mean Time Before Failure (MTBF) is calculated using the Telcordia (Belcore) SR-332 Method 1, Case 3, Issue 1, ground fixed conditions. Operating temperature = +30°C, full output load, natural air convection.
- ⑤ The output may be shorted to ground indefinitely with no damage. The Output Short Circuit Current shown in the specifications is an average consisting of very short bursts of full rated current to test whether the output circuit can be repowered.
- ⑥ The On/Off Control is normally driven from a switch or relay. An open collector/open drain transistor may be used in saturation and cut-off (pinch-off) modes. External logic may also be used if voltage levels are fully compliant to the specifications.
- ⑦ Regulation specifications describe the deviation as the input line voltage or output load current is varied from a nominal midpoint value to either extreme (50% load).
- ⑧ Do not exceed maximum power ratings, Sense limits or output overvoltage when adjusting output trim values.
- ⑨ At zero output current, V_{out} may contain components which slightly exceed the ripple and noise specifications.
- ⑩ Output overload protection is non-latching. When the output overload is removed, the output will automatically recover.
- ⑪ All models are fully operational and meet published specifications, including "cold start" at -40°C.
- ⑫ The converter will shut off if the input falls below the undervoltage threshold. It will not restart until the input exceeds the Input Start Up Voltage.
- ⑬ Short circuit shutdown begins when the output voltage degrades approximately 2% from the selected setting.
- ⑭ Output noise may be further reduced by installing an external filter. See the Application Notes. Use only as much output filtering as needed ***and no more***. Larger caps (especially low-ESR ceramic types) may slow transient response or degrade dynamic performance. Thoroughly test your application with all components installed.
- ⑮ To avoid damage or unplanned shutdown, do not sink appreciable reverse output current.
- ⑯ If reverse polarity is accidentally applied to the input, always connect an external fast blow input fuse in series with the + V_{IN} input.
- ⑰ Although extremely unlikely, failure of the internal components of this product may expose external application circuits to dangerous voltages, currents, temperatures or power levels. Please thoroughly verify all applications before committing them to service. Be sure to include appropriately rated FUSES (see specifications and Application Notes) to reduce the risk of failure.
- ⑱ If Sense is not wired to an external load, connect sense pins to their respective V_{out} pins. Do not leave sense unconnected.
- ⑲ All models use fixed switching frequencies.

TYPICAL PERFORMANCE DATA, ULS-12/5-D48

Efficiency and Power Dissipation vs. Line Voltage and Load Current @ 25°C

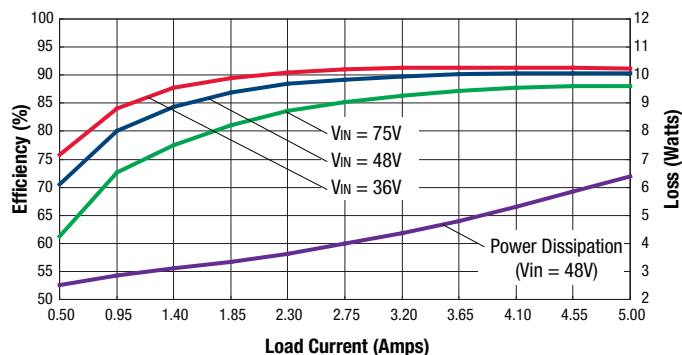

Maximum Current Temperature Derating at Sea Level
(Vin = 48V, airflow is from Vin to Vout)

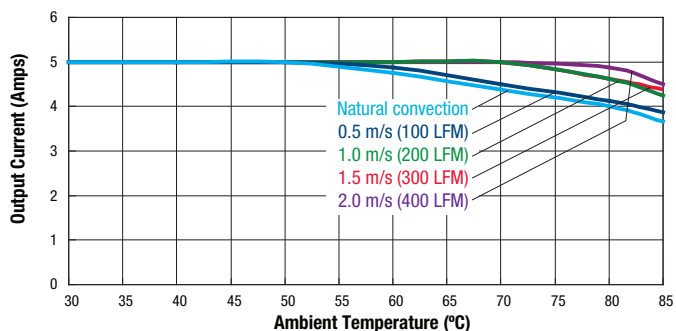

Enable Start-up (Vin=48V, Iout=5A, Ta=+25°C) Trace 2=Output, Trace 4= Enable.

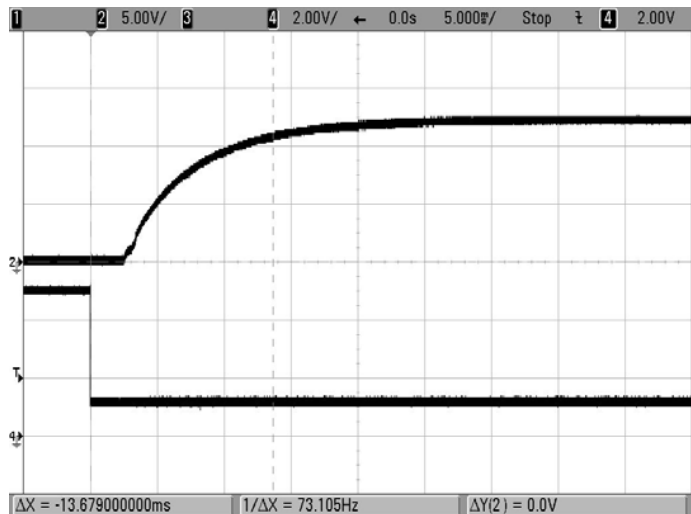

Enable Start-up (Vin=48V, Iout=0A, Ta=+25°C) Trace 2=Output, Trace 4= Enable.



Enable Start-up (Vin=48V, Iout=5A, Cload=1000uF Ta=+25°C) Trace 2=Output, Trace 4= Enable.

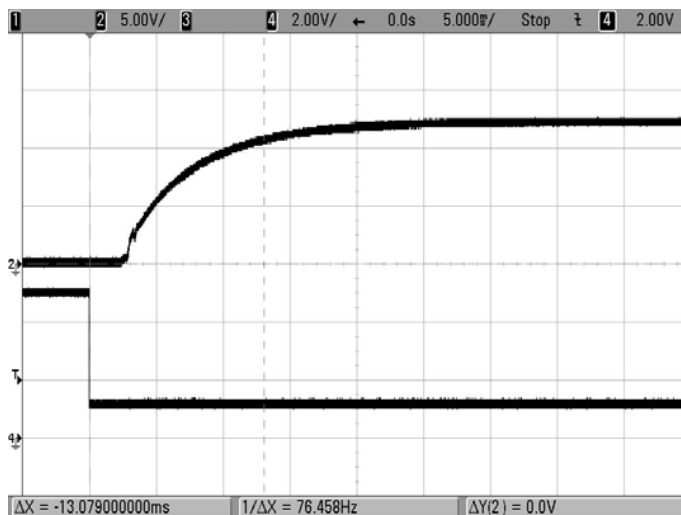

TYPICAL PERFORMANCE DATA, ULS-12/5-D48 (CONT.)

Output and Ripple Noise (Vin=48V, Iout=0A, 1uF Ceramic and 10uF tantalum capacitors)

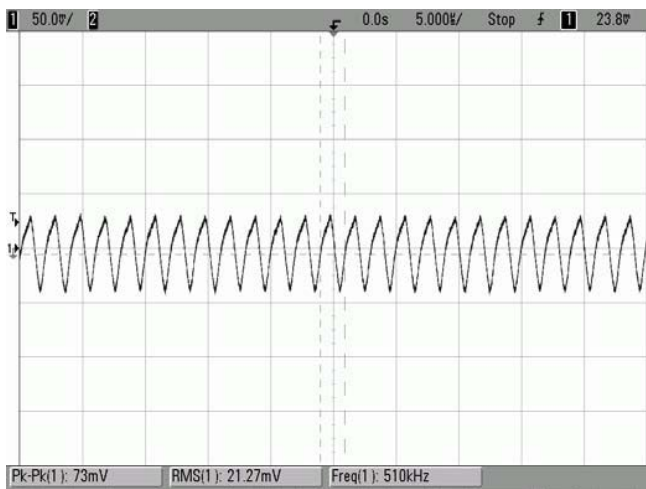

Output and Ripple Noise (Vin=48V, Iout=5A, 1uF Ceramic and 10uF tantalum capacitors)

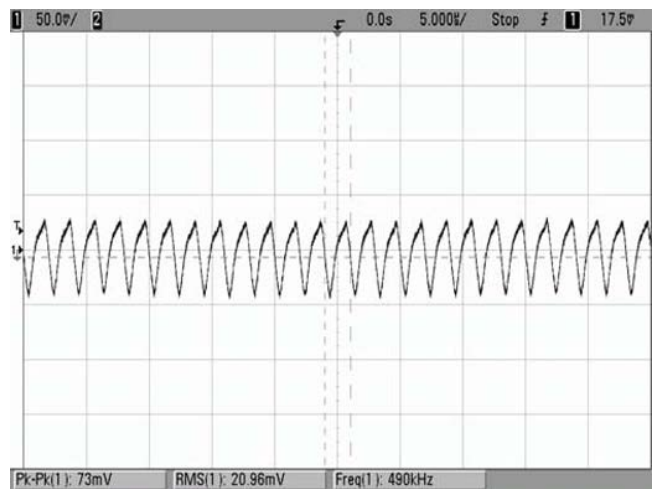

Transient Response (Vin=48V, Iout=50-75-50% of Imax)
(Delta=170mV, Recovery time=16uS)

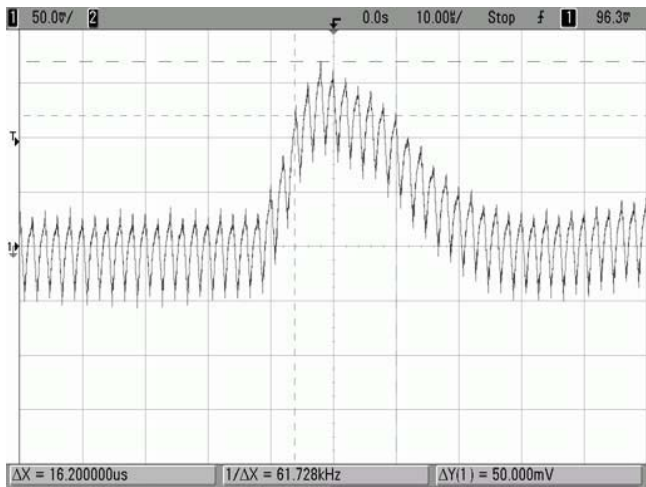

Transient Response (Vin=48V, Iout=50-75-50% of Imax)
(-Delta=183.12mV, Recovery time=18.2uS)

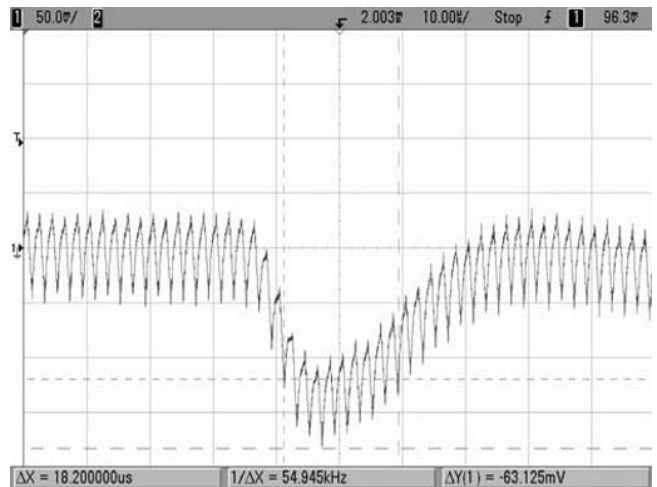

Transient Response (Vin=48V, Iout=50-75-50% of Imax)

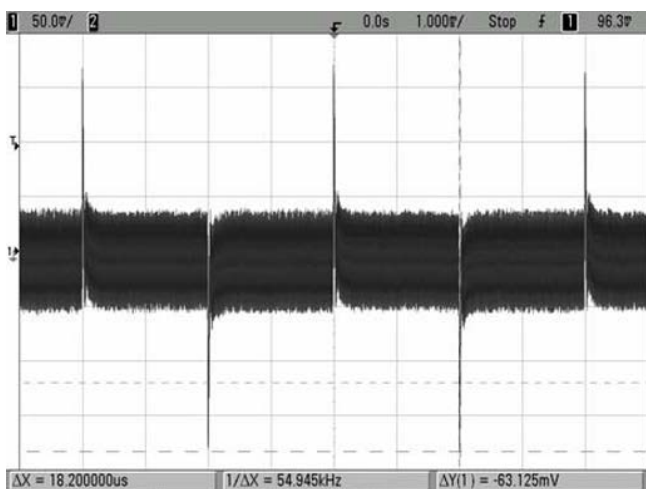

Thermal image with hot spot at full load with 85 °C ambient; air is flowing at 400LFM. Air if flowing across the converter from -V to +V at 48V input. Identifiable and recommended value to be verified in application. (Q2, max temp=120 °C/IPC9592 guidelines)

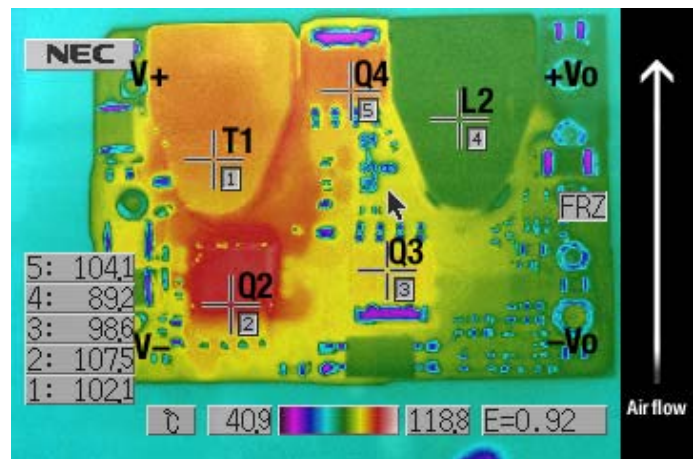

MECHANICAL SPECIFICATIONS, THROUGH-HOLE MOUNT

TOP VIEW

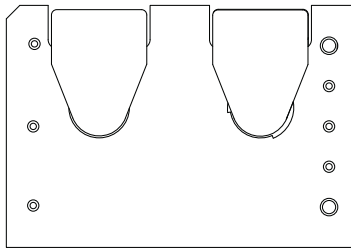

SIDE VIEW

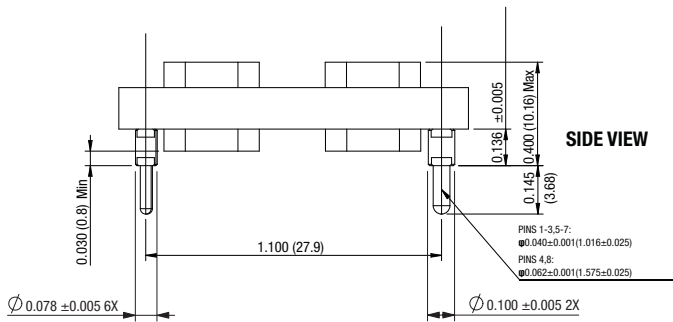

BOTTOM PIN VIEW

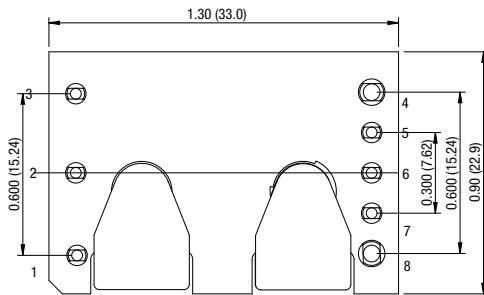

END VIEW

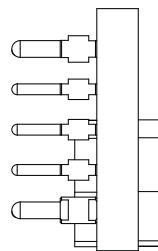

**RECOMMENDED FOOTPRINT
(VIEW THROUGH CONVERTER)**

TOP VIEW

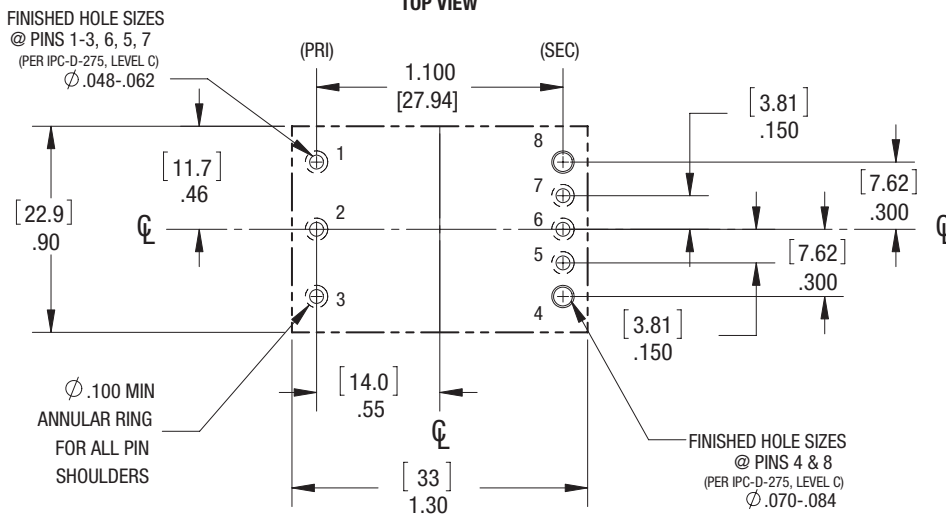

INPUT/OUTPUT CONNECTIONS P75			
Pin	Function	Pin	Function
3	-Vin	4	-Vout
		5	-Sense In
2	On/Off Control	6	Trim
		7	+Sense In
1	+Vin	8	+Vout

Important! **Always** connect the sense pins. If they are not connected to a remote load, wire each sense pin to its respective voltage output at the converter pins.

The 0.145-inch pin length is shown. Please refer to the part number structure for alternate pin lengths. Pin material: Copper alloy. Plating: Gold over nickel

Please note that some competitive units may use different pin numbering or alternate outline views; however, all units are plugin-compatible.

It is recommended that no parts be placed beneath the converter

Dimensions are in inches (mm) shown for ref. only.

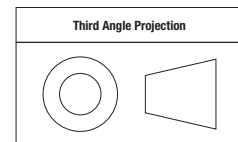

Tolerances (unless otherwise specified):
 .XX ± 0.02 (0.5)
 .XXX ± 0.010 (0.25)
 Angles ± 2°

Components are shown for reference only and may vary between units.

SHIPPING TRAYS AND BOXES, THROUGH-HOLE MOUNT

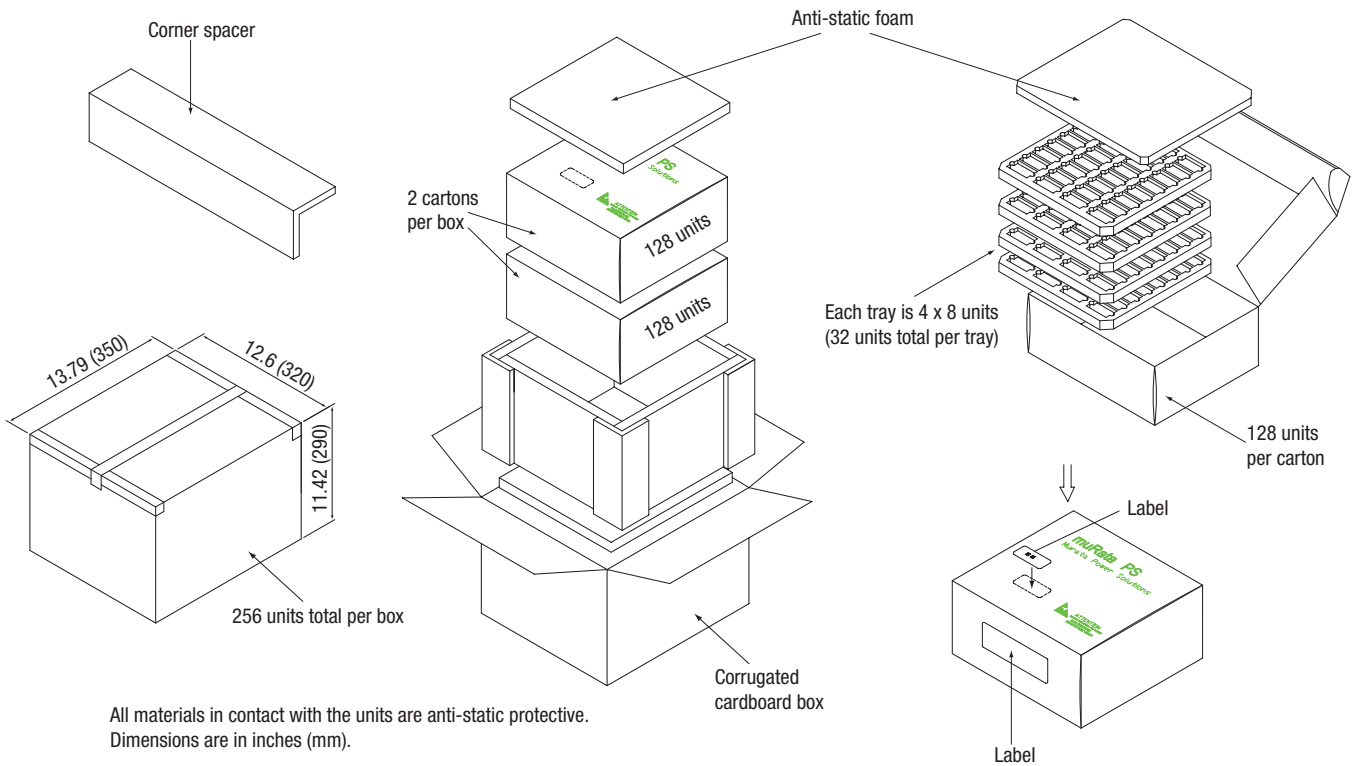

SHIPPING TRAY DIMENSIONS

Material: Low density, closed cell polyethylene anti-static foam

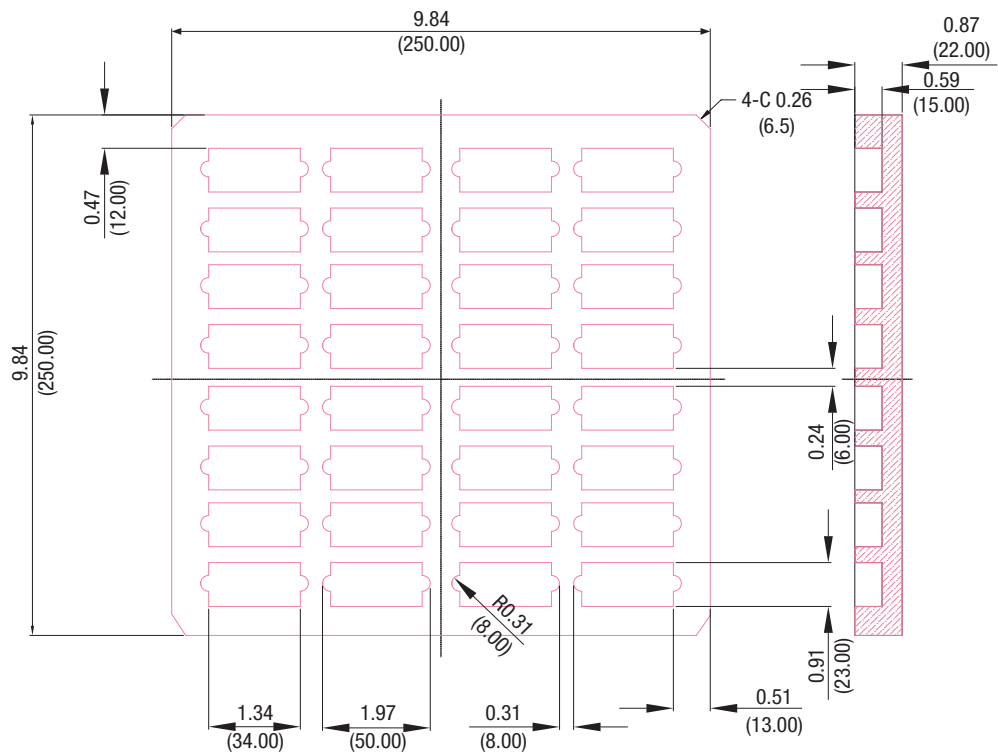

Dimensions are in millimeters.

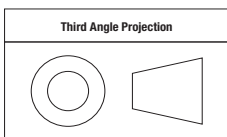

Tolerances (unless otherwise specified):
.XX ± 0.5
.XXX ± 0.25
Angles ± 2°

MECHANICAL SPECIFICATIONS, SURFACE MOUNT (MSL = 3)

TOP VIEW

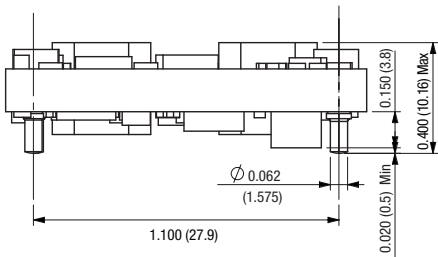
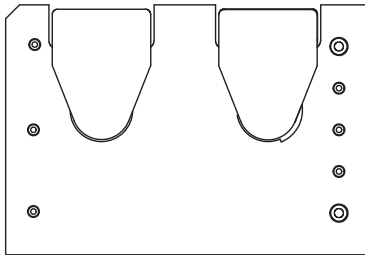

SIDE VIEW

BOTTOM PIN VIEW

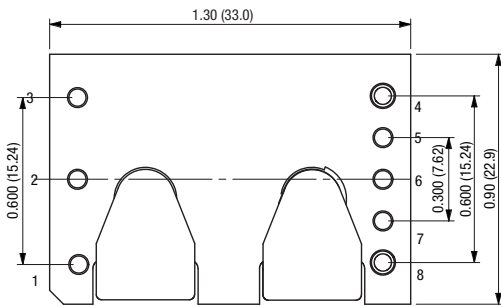

END VIEW

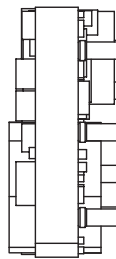

**RECOMMENDED FOOTPRINT
(VIEW THROUGH CONVERTER)**

TOP VIEW

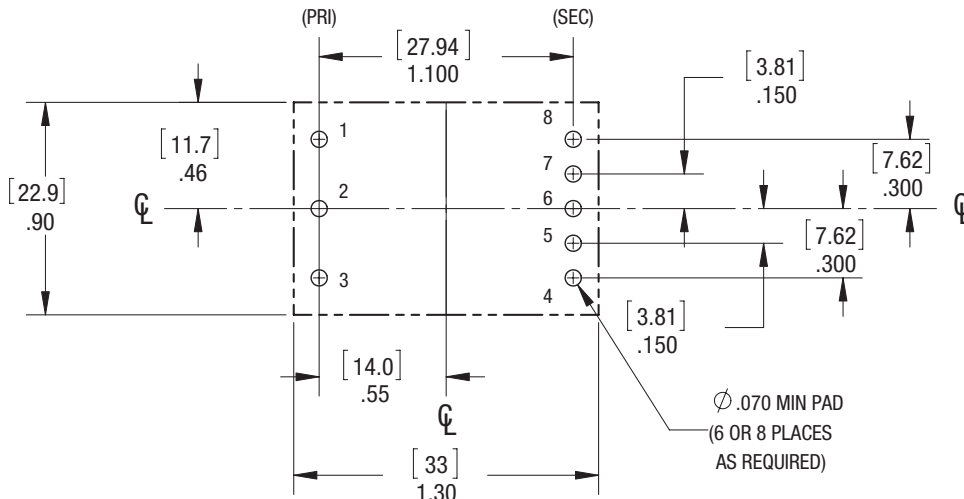

INPUT/OUTPUT CONNECTIONS P75			
Pin	Function	Pin	Function
3	-Vin	4	-Vout
		5	-Sense In
2	On/Off Control	6	Trim
		7	+Sense In
1	+Vin	8	+Vout

Important! **Always** connect the sense pins. If they are not connected to a remote load, wire each sense pin to its respective voltage output at the converter pins.

Pin material: Copper alloy. Plating: Gold over nickel

Please note that some competitive units may use different pin numbering or alternate outline views; however, all units are plugin-compatible.

It is recommended that no parts be placed beneath the converter

Dimensions are in inches (mm) shown for ref. only.

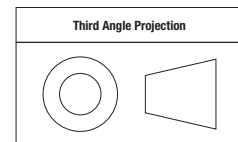

Tolerances (unless otherwise specified):
 .XX ± 0.02 (0.5)
 .XXX ± 0.010 (0.25)
 Angles ± 2'

Components are shown for reference only and may vary between units.

TAPE AND REEL INFORMATION

FEED (UNWIND) DIRECTION 

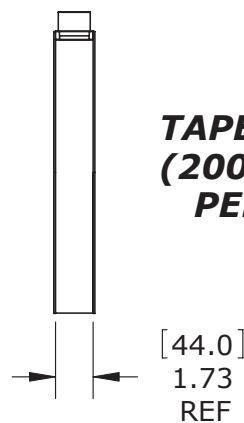
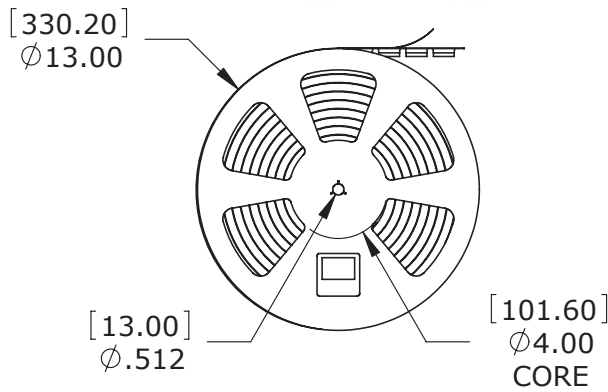
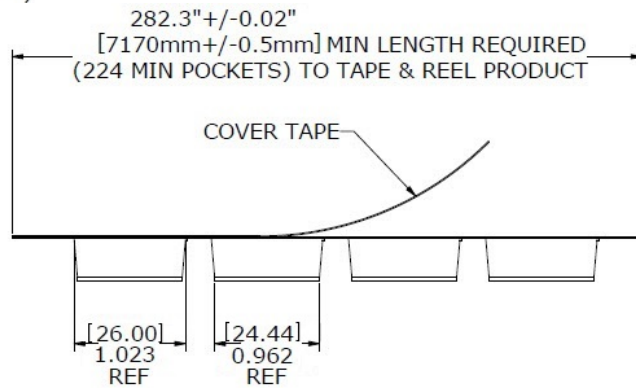
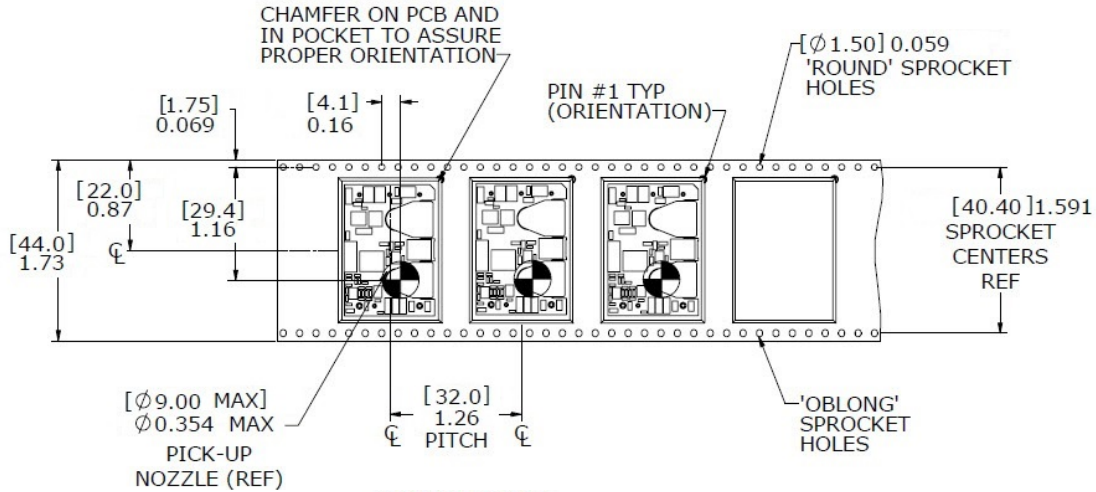

**TAPE AND REEL
(200 UNITS
PER REEL)**

Dimensions are in inches (mm shown for ref. only).

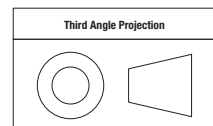

Tolerances (unless otherwise specified):
.XX ± 0.02 (0.5)
.XXX ± 0.010 (0.25)
Angles ± 1°

Components are shown for reference only.

TECHNICAL NOTES

Input Fusing

Certain applications and/or safety agencies may require the installation of fuses at the inputs of power conversion components. Fuses should also be used if the possibility of sustained, non-current-limited, input-voltage polarity reversals exists. For DATEL ULS series DC/DC converters, we recommend the use of a fast blow fuse, installed in the ungrounded input supply line with a typical value about twice the maximum input current, calculated at low line with the converter's minimum efficiency.

All relevant national and international safety standards and regulations must be observed by the installer. For system safety agency approvals, the converters must be installed in compliance with the requirements of the end-use safety standard.

Input Reverse-Polarity Protection

If the input voltage polarity is accidentally reversed, an internal diode will become forward biased and likely draw excessive current from the power source. If this source is not current limited or the circuit appropriately fused, it could cause permanent damage to the converter.

Pre-Bias Protection

For applications where a pre-bias potential can be present at the output of the power module it is recommended that either blocking diodes are added in series with the V_{OUT} power lines or, a preferred solution is to use an OR-ing FET controller like the LM5050-1 High-Side & LM5051 Low-Side OR-ing FET Controller from TI. Starting the module into a pre-bias condition can cause permanent damage to the module.

Input Under-Voltage Shutdown and Start-Up Threshold

Under normal start-up conditions, devices will not begin to regulate properly until the ramping-up input voltage exceeds the Start-Up Threshold Voltage. Once operating, devices will not turn off until the input voltage drops below the Under-Voltage Shutdown limit. Subsequent re-start will not occur until the input is brought back up to the Start-Up Threshold. This built-in hysteresis prevents any unstable on/off situations from occurring at a single input voltage.

Start-Up Time

The V_{IN} to V_{OUT} Start-Up Time is the time interval between the point at which the ramping input voltage crosses the Start-Up Threshold and the fully loaded output voltage enters and remains within its specified accuracy band. Actual measured times will vary with input source impedance, external input capacitance, and the slew rate and final value of the input voltage as it appears at the converter. The ULS Series implements a soft start circuit to limit the duty cycle of its PWM controller at power up, thereby limiting the input inrush current.

The On/Off Control to V_{OUT} start-up time assumes the converter has its nominal input voltage applied but is turned off via the On/Off Control pin. The specification defines the interval between the point at which the converter is turned on (released) and the fully loaded output voltage enters and remains within its specified accuracy band. Similar to the V_{IN} to V_{OUT} start-up, the On/Off Control to V_{OUT} start-up time is also governed by the internal soft start circuitry and external load capacitance. The difference in start up time from V_{IN} to V_{OUT} and from On/Off Control to V_{OUT} is therefore insignificant.

Input Source Impedance

The input of ULS converters must be driven from a low ac-impedance source. The DC/DC's performance and stability can be compromised by the use of

highly inductive source impedances. The input circuit shown in Figure 3 is a practical solution that can be used to minimize the effects of inductance in the input traces. For optimum performance, components should be mounted close to the DC/DC converter.

I/O Filtering, Input Ripple Current, and Output Noise

All models in the ULS Series are tested/specified for input reflected ripple current and output noise using the specified external input/output components/circuits and layout as shown in the following two figures. External input capacitors (C_{IN} in Figure 3) serve primarily as energy-storage elements, minimizing line voltage variations caused by transient IR drops in conductors from backplane to the DC/DC. Input caps should be selected for bulk capacitance (at appropriate frequencies), low ESR, and high rms-ripple-current ratings. The switching nature of DC/DC converters requires that dc voltage sources have low ac impedance as highly inductive source impedance can affect system stability. In Figure 3, C_{BUS} and L_{BUS} simulate a typical dc voltage bus. Your specific system configuration may necessitate additional considerations.

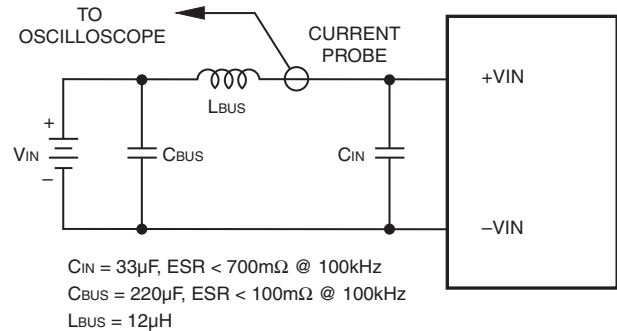

Figure 3. Measuring Input Ripple Current

In critical applications, output ripple/noise (also referred to as periodic and random deviations or PARD) may be reduced below specified limits using filtering techniques, the simplest of which is the installation of additional external output capacitors. They function as true filter elements and should be selected for bulk capacitance, low ESR and appropriate frequency response.

All external capacitors should have appropriate voltage ratings and be located as close to the converter as possible. Temperature variations for all relevant parameters should also be taken carefully into consideration. The most effective combination of external I/O capacitors will be a function of line voltage and source impedance, as well as particular load and layout conditions.

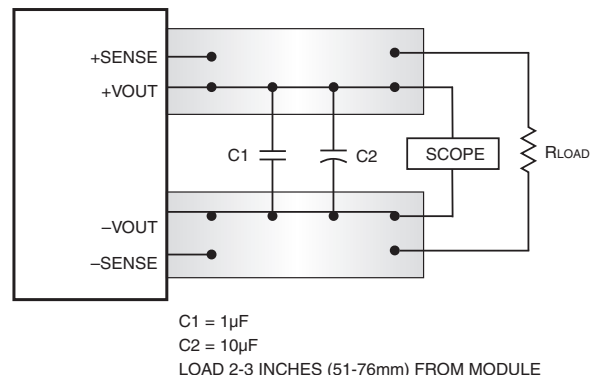

Figure 4. Measuring Output Ripple/Noise (PARD)

Floating Outputs

Since these are isolated DC/DC converters, their outputs are “floating” with respect to their input. Designers will normally use the –Output as the ground/return of the load circuit. You can however, use the +Output as ground/return to effectively reverse the output polarity.

Minimum Output Loading Requirements

ULS converters employ a synchronous-rectifier design topology and all models regulate within spec and are stable under no-load to full load conditions. Operation under no-load conditions however might slightly increase the output ripple and noise.

Thermal Shutdown

The ULS converters are equipped with thermal-shutdown circuitry. If environmental conditions cause the temperature of the DC/DC converter to rise above the designed operating temperature, a precision temperature sensor will power down the unit. When the internal temperature decreases below the threshold of the temperature sensor, the unit will self start. See Performance/Functional Specifications.

Output Over-Voltage Protection

The ULS output voltage is monitored for an over-voltage condition using a comparator. The signal is optically coupled to the primary side and if the output voltage rises to a level which could be damaging to the load, the sensing circuitry will power down the PWM controller causing the output voltage to decrease. Following a time-out period the PWM will restart, causing the output voltage to ramp to its appropriate value. If the fault condition persists, and the output voltage again climbs to excessive levels, the over-voltage circuitry will initiate another shutdown cycle. This on/off cycling is referred to as “hiccup” mode.

Current Limiting

As soon as the output current increases to approximately 130% of its rated value, the DC/DC converter will go into a current-limiting mode. In this condition, the output voltage will decrease proportionately with increases in output current, thereby maintaining somewhat constant power dissipation. This is commonly referred to as power limiting. Current limit inception is defined as the point at which the full-power output voltage falls below the specified tolerance. See Performance/Functional Specifications. If the load current, being drawn from the converter, is significant enough, the unit will go into a short circuit condition as described below.

Short Circuit Condition

When a converter is in current-limit mode, the output voltage will drop as the output current demand increases. If the output voltage drops too low, the magnetically coupled voltage used to develop primary side voltages will also drop, thereby shutting down the PWM controller. Following a time-out period, the PWM will restart causing the output voltage to begin ramping to their appropriate value. If the short-circuit condition persists, another shutdown cycle will be initiated. This on/off cycling is referred to as “hiccup” mode. The hiccup cycling reduces the average output current, thereby preventing internal temperatures from rising to excessive levels. The ULS Series is capable of enduring an indefinite short circuit output condition.

Remote Sense

Note: The Sense and V_{OUT} lines are internally connected through low-value resistors. Nevertheless, if the sense function is not used for remote regulation the user should connect the +Sense to +V_{OUT} and –Sense to –V_{OUT} at the DC/DC converter pins. ULS series converters employ a sense feature to provide point of use regulation, thereby overcoming moderate IR drops in PCB conductors or cabling. The remote sense lines carry very little current and therefore require minimal cross-sectional-area conductors. The sense lines, which are capacitively coupled to their respective output lines, are used by the feedback control-loop to regulate the output. As such, they are not low impedance points and must be treated with care in layouts and cabling. Sense lines on a PCB should be run adjacent to dc signals, preferably ground.

$$[V_{OUT(+)} - V_{OUT(-)}] - [Sense(+)-Sense(-)] \leq 10\%V_{OUT}$$

In cables and discrete wiring applications, twisted pair or other techniques should be used. Output over-voltage protection is monitored at the output voltage pin, not the Sense pin. Therefore, excessive voltage differences between V_{OUT} and Sense in conjunction with trim adjustment of the output voltage can cause the over-voltage protection circuitry to activate (see Performance Specifications for over-voltage limits). Power derating is based on maximum output current and voltage at the converter’s output pins. Use of trim and sense functions can cause output voltages to increase, thereby increasing output power beyond the converter’s specified rating, or cause output voltages to climb into the output over-voltage region. Therefore, the designer must ensure:

$$(V_{OUT \text{ at pins}}) \times (I_{OUT}) \leq \text{rated output power}$$

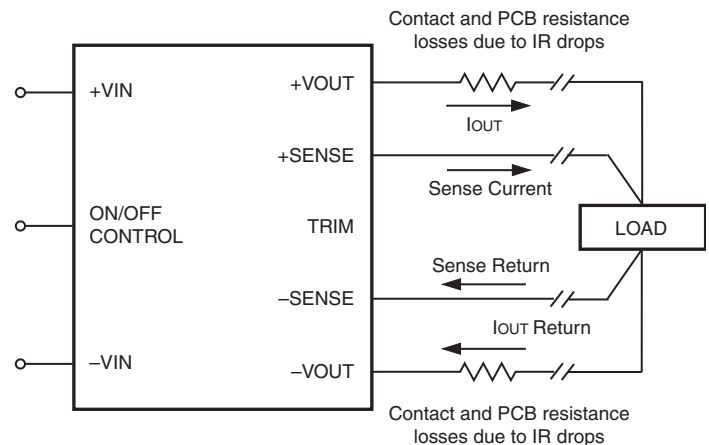

Figure 5. Remote Sense Circuit Configuration

On/Off Control

The input-side, remote On/Off Control function can be ordered to operate with either logic type:

Positive (“P” suffix) logic models are enabled when the on/off pin is left open (or is pulled high, applying +3.5V to +15V with respect to –Input) as per Figure 6. Positive-logic devices are disabled when the on/off pin is pulled low (0 to 1V with respect to –Input).

Negative (“N” suffix) logic devices are off when pin is left open (or pulled high, applying +2.5V to +15V), and on when pin is pulled low (–0.1 to +0.8V) with respect to –Input as shown in Figure 6.

Dynamic control of the remote on/off function is best accomplished with a mechanical relay or an open-collector/open-drain drive circuit (optically isolated if appropriate). The drive circuit should be able to sink appropriate current (see Performance Specifications) when activated and withstand appropriate voltage when deactivated. Applying an external voltage to pin 2 when no input power is applied to the converter can cause permanent damage to the converter.

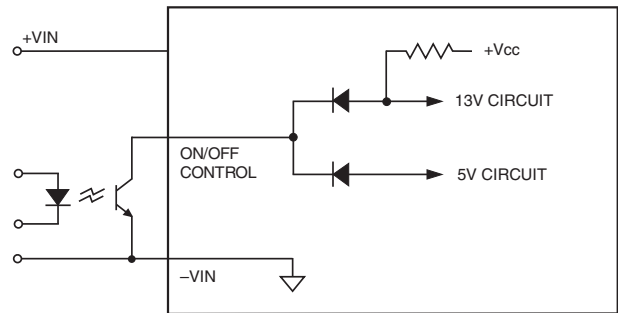

Figure 6. Driving the Negative Logic On/Off Control Pin (simplified circuit)

OUTPUT VOLTAGE ADJUSTMENT

Trim Equations

Trim Down

$$R_{T_DOWN} (k\Omega) = \frac{511}{\Delta\%} - 10.22$$

$$\text{Where } \Delta\% = \left(\left(\frac{V_{NOM} - V_{DES}}{V_{NOM}} \times 100 \right) \right)$$

Trim Up

$$R_{T_UP} (k\Omega) = \frac{5.11 \times V_{NOM} \times (100 + \Delta\%)}{1.225 \times \Delta\%} - \frac{511}{\Delta\%} - 10.22$$

Note: “Δ%” is always a positive value.
“V_{NOM}” is the nominal, rated output voltage.
“V_{DES}” is the desired, changed output voltage.

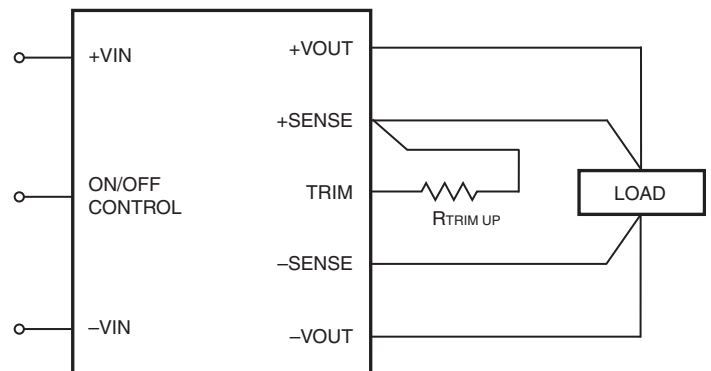

Figure 7. Trim Connections To Increase Output Voltages
Connect sense to its respective V_{OUT} pin if sense is not used with a remote load.

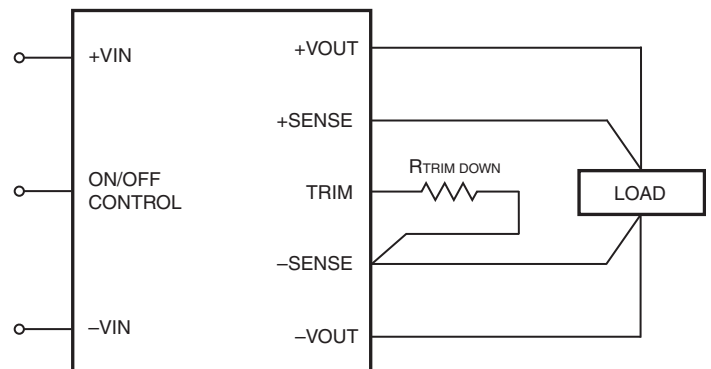

Figure 8. Trim Connections To Decrease Output Voltages

Trimming by Using an External Voltage Source

1. The easiest way to trim the output using an external voltage source is to drive the Trim pin directly from a variable source. The following equation can be used to calculate the voltage at the Trim pin.

V_o is the output voltage you want; V_{nominal} is the nominal output voltage;

$$V_{\text{trim}} = 2 \times 1.225 \times \frac{V_o}{V_{\text{nominal}}} - 1.225$$

V_{trim} is the voltage that should appear at the trim pin.

2. If the purpose of trimming is to compensate voltage drop of power path from converter to the Load, you may separately connect the sense pin directly to the load. It's much easier than real time adjusting trim voltage.

3. CAUTION: To avoid unplanned power down cycles, do not exceed EITHER the maximum output voltage OR the maximum output power when setting the trim. If the output voltage is excessive, the OVP circuit may shut down the converter. If the maximum power is exceeded, the converter may enter current limiting. If the power is exceeded for an extended period, the converter may overheat and encounter overtemperature shut down. Be careful of external electrical noise. The Trim input is a sensitive input to the converter's feedback control loop. Excessive electrical noise may cause instability or oscillation.

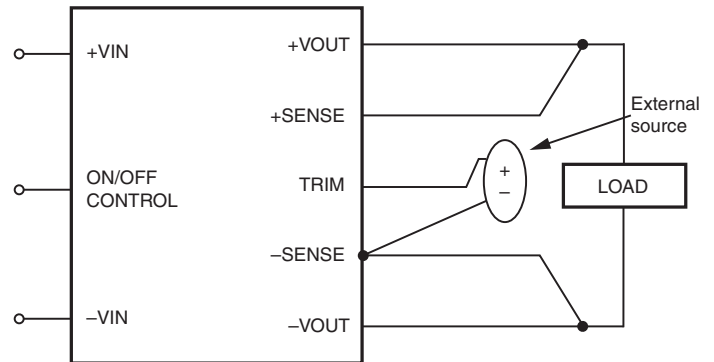

Figure 9. Trimming with an External Source

Through-hole Soldering Guidelines

Murata Power Solutions recommends the TH soldering specifications below when installing these converters. These specifications vary depending on the solder type. Exceeding these specifications may cause damage to the product. Your production environment may differ; therefore please thoroughly review these guidelines with your process engineers.

Wave Solder Operations for through-hole mounted products (THMT)	
For Sn/Ag/Cu based solders:	
Maximum Preheat Temperature	115° C.
Maximum Pot Temperature	270° C.
Maximum Solder Dwell Time	7 seconds
For Sn/Pb based solders:	
Maximum Preheat Temperature	105° C.
Maximum Pot Temperature	250° C.
Maximum Solder Dwell Time	6 seconds

SMT Reflow Soldering Guidelines

The surface-mount reflow solder profile shown below is suitable for SAC305 type lead-free solders. This graph should be used only as a **guideline**. Many other factors influence the success of SMT reflow soldering. Since your production environment may differ, please thoroughly review these guidelines with your process engineers.

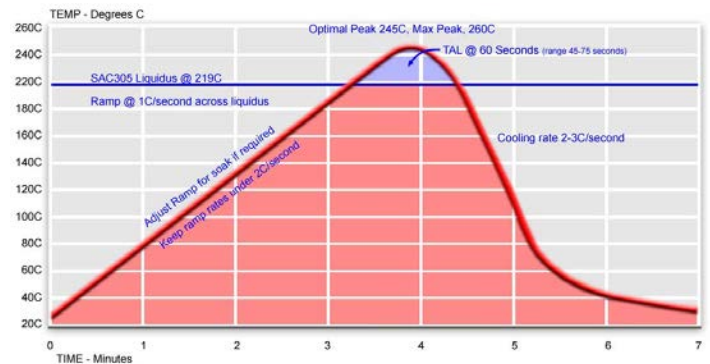

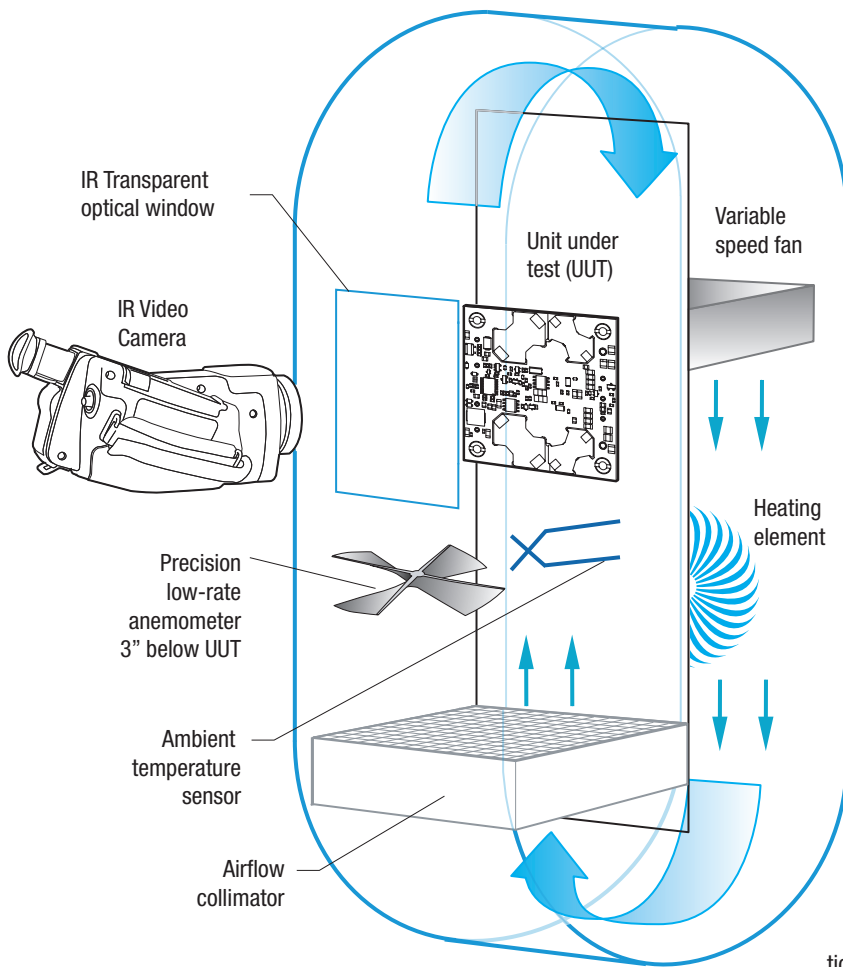

Figure 10. Vertical Wind Tunnel

Vertical Wind Tunnel

Murata Power Solutions employs a computer controlled custom-designed closed loop vertical wind tunnel, infrared video camera system, and test instrumentation for accurate airflow and heat dissipation analysis of power products. The system includes a precision low flow-rate anemometer, variable speed fan, power supply input and load controls, temperature gauges, and adjustable heating element.

The IR camera monitors the thermal performance of the Unit Under Test (UUT) under static steady-state conditions. A special optical port is used which is transparent to infrared wavelengths.

Both through-hole and surface mount converters are soldered down to a host carrier board for realistic heat absorption and spreading. Both longitudinal and transverse airflow studies are possible by rotation of this carrier board since there are often significant differences in the heat dissipation in the two airflow directions. The combination of adjustable airflow, adjustable ambient heat, and adjustable Input/Output currents and voltages mean that a very wide range of measurement conditions can be studied.







The collimator reduces the amount of turbulence adjacent to the UUT by minimizing airflow turbulence. Such turbulence influences the effective heat transfer characteristics and gives false readings. Excess turbulence removes more heat from some surfaces and less heat from others, possibly causing uneven overheating.

Both sides of the UUT are studied since there are different thermal gradients on each side. The adjustable heating element and fan, built-in temperature gauges, and no-contact IR camera mean that power supplies are tested in real-world conditions.

Product Model Specific Availability:

MPS Part Number	Product Status	LTB Date
ULS-12/5-D48N-C	In Production	N/A
ULS-12/5-D48NH-C	Discontinued	3/31/2022
ULS-12/5-D48NH-Y	Discontinued	3/31/2022
ULS-12/5-D48NL1-C	In Production	N/A
ULS-12/5-D48NL2-C	Discontinued	3/31/2022
ULS-12/5-D48NM-C	Discontinued	3/31/2022
ULS-12/5-D48N-Y	Discontinued	3/31/2022
ULS-12/5-D48P-C	Discontinued	3/31/2022
ULS-12/5-D48PH-C	Discontinued	3/31/2022
ULS-12/5-D48PH-Y	Discontinued	3/31/2022
ULS-12/5-D48PL2-C	Discontinued	3/31/2022
ULS-12/5-D48PM-C	Discontinued	3/31/2022
ULS-12/5-D48P-Y	Discontinued	3/31/2022
ULS-3.3/20-D48N-C	Discontinued	3/31/2022
ULS-3.3/20-D48NH-C	Discontinued	3/31/2022
ULS-3.3/20-D48NH-Y	Discontinued	3/31/2022
ULS-3.3/20-D48NL2-C	Discontinued	3/31/2022
ULS-3.3/20-D48NL2-Y	Discontinued	3/31/2022
ULS-3.3/20-D48NM-C	Discontinued	3/31/2022
ULS-3.3/20-D48N-Y	Discontinued	3/31/2022
ULS-3.3/20-D48PB-C	Discontinued	3/31/2022
ULS-3.3/20-D48P-C	Discontinued	3/31/2022
ULS-3.3/20-D48PH-C	Discontinued	3/31/2022
ULS-3.3/20-D48PH-Y	Discontinued	3/31/2022
ULS-3.3/20-D48PM-C	Discontinued	3/31/2022
ULS-3.3/20-D48P-Y	Discontinued	3/31/2022
ULS-5/12-D48N-C	Discontinued	3/31/2022
ULS-5/12-D48NH-C	Discontinued	3/31/2022
ULS-5/12-D48NH-Y	Discontinued	3/31/2022
ULS-5/12-D48NL1-C	Discontinued	3/31/2022
ULS-5/12-D48NM-C	Discontinued	3/31/2022
ULS-5/12-D48N-Y	Discontinued	3/31/2022
ULS-5/12-D48P-C	Discontinued	3/31/2022
ULS-5/12-D48PH-C	Discontinued	3/31/2022
ULS-5/12-D48PH-Y	Discontinued	3/31/2022
ULS-5/12-D48PL2-C	Discontinued	3/31/2022
ULS-5/12-D48PM-C	Discontinued	3/31/2022
ULS-5/12-D48P-Y	Discontinued	3/31/2022

Product Status

	Products under development. Listed product specifications are subject to change without prior notice. Please contact us for sample availability and mass production schedule.
	Product is in mass production.
	Not recommended for new design.
	We are planning to discontinue production of this item. 'Last Time Buy' date or Discontinuation date may be shown on our web site. Before these dates, please contact us with your requirements.
	Production of this product has stopped.
	Murata particularly recommends this product for reasons of size and performance. Please contact Murata regarding pricing and delivery.
	This is a new product. Please contact Murata regarding pricing and delivery.

Link back to [part number configuration](#)

Murata Power Solutions, Inc.
129 Flanders Road, Westborough, MA 01581 U.S.A.
ISO 9001 REGISTERED



This product is subject to the following [operating requirements](#) and the [Life and Safety Critical Application Sales Policy](#): Refer to: <https://www.murata-ps.com/requirements/>

Murata Power Solutions, Inc. makes no representation that the use of its products in the circuits described herein, or the use of other technical information contained herein, will not infringe upon existing or future patent rights. The descriptions contained herein do not imply the granting of licenses to make, use, or sell equipment constructed in accordance therewith. Specifications are subject to change without notice.
©2023 Murata Power Solutions, Inc.