



FEATURES

- UL62368-1 recognised
- EN62368-1 certified
- IEC61558-1 & IEC61558-2-16 certified
- ANSI/AAMI ES60601-1, 1 MOPP/2 MOOP recognition pending
- Wide input voltage range 85-264VAC/120-370VDC
- Operating temperature range -40°C to 85°C
- 4.7kVDC isolation 'Hi Pot Test'
- 5V, 12V & 24V single regulated outputs
- Over current protection
- Short circuit protection
- Primary side regulation
- Meets EMC class B with no external components
- No external components required

PRODUCT OVERVIEW

The BAC05 series delivers an output power of 5 watts from -40°C to 55°C, operating up to 85°C with derating, from AC or DC input voltages. The BAC05 series small footprint is EMC class B compliant without the need of any external components. The BAC05 series is suited to medical applications with 1 MOPP and 2 MOOP.

With high efficiency at low loads and low no load power consumption, the BAC05 supports standby mode operation for applications in industrial, medical, automation, IOT as well as household and home automation.



For full details go to <https://www.murata.com/en-global/products/power/rohs>

SELECTION GUIDE

Order Code	Output Power W	Output Voltage V	Output Current A	Ripple & Noise				Efficiency				Isolation Capacitance pF	MTTF ¹	
				115V		230V		115V		230V			MIL 217	Telcordia
				Typ.	Max.	Typ.	Max.	Min.	Typ.	Min.	Typ.			
				mVp-p				%					kHrs	
BAC05S05DC	5	5	1	35	50	35	50	72	75.5	72	76	45	882	8793
BAC05S12DC	5	12	0.42	65	120	65	120	76	79	76	79	45	866	12571
BAC05S24DC	5	24	0.21	110	200	120	200	78	81	78	80.5	45	1144	16698

INPUT CHARACTERISTICS

Parameter	Conditions	Min.	Typ.	Max.	Units
Voltage range	All input types	85	115/230	264	VAC
	All input types	120		370	VDC
Input frequency		47	50/60	63	Hz
Switching frequency			64		kHz
Input current	Nominal Vin = 115VAC		100		mA
	Nominal Vin = 230VAC		60		
Inrush current	Nominal Vin = 115VAC		11		A
	Nominal Vin = 230VAC		23		
Input leakage current	250VAC		25		µA
No load power consumption	BAC05S05DC	115V		45	mW
		230V		88	
	BAC05S12DC	115V		45	
		230V		129	
	BAC05S24DC	115V		65	
		230V		129	

ISOLATION CHARACTERISTICS

Parameter	Conditions	Min.	Typ.	Max.	Units
Isolation test voltage	Production tested for 1 second	4700			VDC
	Qualification tested for 1 minute	4700			
Resistance	Viso = 1000VDC	100			MΩ
Safety standard	UL62368-1	Reinforced	Creepage and clearance 8.4mm	240	Vrms
	EN62368-1			240	
	ANSI/AAMI ES60601-1 ²			240	

TEMPERATURE CHARACTERISTICS

Parameter	Conditions	Min.	Typ.	Max.	Units
Operation	Convection cooling 0.2m/s	-40		85	°C
Storage		-40		85	
Product temperature rise above ambient	BAC05S05DC		33		
	BAC05S12DC		27		
	BAC05S24DC		26		

1. Calculated using MIL-HDBK-217F and Telcordia SR-332 calculation model at T_A=25°C with nominal input voltage 115VAC at full load.

2. ANSI/AAMI ES60601-1 recognition is currently pending.

All specifications typical at T_A=25°C, nominal input voltage and rated output current unless otherwise specified.

OUTPUT CHARACTERISTICS						
Parameter	Conditions		Min.	Typ.	Max.	Units
Minimum load			10			%
Initial voltage accuracy	All output types				±4	%
Line regulation	Low line to high line	BAC05S05DC		±0.06	±0.5	%
		BAC05S12DC		±0.01	±0.5	
		BAC05S24DC		±0.08	±0.5	
Load regulation	10% total load to 100% total load	115VAC	BAC05S05DC	±0.4	±1	%
		230VAC		All others	±0.1	
			BAC05S05DC	±0.4	±1	
			BAC05S12DC	±0.15	±1	
			BAC05S24DC	±0.1	±1	
		Temperature coefficient				
Transient response	Peak deviation - 50-75% & 75-50% swing			±2		%Vout
	Settling time (within 5% Vout Nom.)	BAC05S24DC		3.5		ms
All others			2			
Current limit inception	BAC05S12DC			110		%
	All others			120		
Hold up time	115VAC			15		ms
	230VAC			75		

ABSOLUTE MAXIMUM RATINGS	
Short-circuit protection	Continuous, automatic recovery
Input voltage	277VAC
Lead temperature 1.0mm from case for 7 +2/-0 seconds (to JEDEC JESD22-B106)	270±5°C
Shelf life (1 year)	Please refer to reconditioning application notes.
Wave Solder	Wave Solder profile not to exceed the profile recommended in IEC 61760-1 Section 6.1.3. Please refer to application notes for further information.

TECHNICAL NOTES**ISOLATION VOLTAGE**

'Hi Pot Test', 'Flash Tested', 'Withstand Voltage', 'Proof Voltage', 'Dielectric Withstand Voltage' & 'Isolation Test Voltage' are all terms that relate to the same thing, a test voltage, applied for a specified time, across a component designed to provide electrical isolation, to verify the integrity of that isolation.

Murata Power Solutions BAC05 series of AC/DC converters are all 100% production tested at their stated isolation voltage. This is 4.7kVDC for 1 second.

The BAC05 has been recognised by Underwriters Laboratory to 240Vrms for Reinforced Insulation.

REPEATED HIGH-VOLTAGE ISOLATION TESTING

It is well known that repeated high-voltage isolation testing of a barrier component can actually degrade isolation capability, to a lesser or greater degree depending on materials, construction and environment. We therefore strongly advise against repeated high voltage isolation testing, but if it is absolutely required, that the voltage be reduced by 20% from specified test voltage.

SAFETY APPROVAL**ANSI/AAMI ES60601-1**

The BAC05 series is pending recognition by Underwriters Laboratory (UL) to ANSI/AAMI ES60601-1 and provides 1 MOPP (Means Of Patient Protection) and 2 MOOP (Means Of Operator Protection) based upon a working voltage of 240Vrms max., between Primary and Secondary.

EN62368-1

The BAC05 series has been certified by Demko (D) to EN62368 for reinforced insulation to a working voltage of 240Vrms. File number D-07177 applies.

UL62368

The BAC05 series has been recognised by Underwriters Laboratory (UL) to UL62368 for reinforced insulation to a working voltage of 240Vrms. File number E151252 applies.

Creepage and clearance 8.4mm

Working altitude OVC II 5000m

IEC61558-1 & IEC61558-2-16

The BAC05 series has been certified by TUV SUD to IEC61558-1 & IEC61558-2-16.

RoHS COMPLIANCE INFORMATION

This series is compatible with RoHS soldering systems with a peak wave solder temperature of 260°C for 10 seconds based on IEC 61760-1. Please refer to [application notes](#) for further information. The pin termination finish on this product series is Hot Dipped over Matte Tin with Nickel Preplate. The series is backward compatible with Sn/Pb soldering systems. For further information, please visit www.murata.com/en-global/products/rohs

ENVIRONMENTAL VALIDATION TESTING

The following tests have been conducted on this product series, as part of our design verification process. The datasheet characteristics specify user operating conditions for this series, please contact Murata if further information about the tests is required.

Test	Standard	Condition
Temperature cycling	JEDEC JESD22-A104	200 cycles. -40°C to 105°C, 15 minutes hold at each extreme including transitions.
Humidity bias	JEDEC JESD22-A101	85°C ±2°C, 85±5% R.H. for 1000 (+168/-24) hours
Storage life	JEDEC JESD22-A103	105°C +10/-0°C for ≥1000 hours
Vibration	BS EN 61373 with respect to BS EN 60068-2-64, Test Fh Category 1 Class B	5 – 150Hz. Level at each axis – Vertical, Traverse and Longitudinal: 5.72m/s ² rms. 5 hours in each axis. Crest factor: 3 Sigma. Device is secured via the pins.
Shock	BS EN 61373: Category 1 Class B	Test is 30ms duration, 3 shocks in each sense of 3 mutually perpendicular axes (18 shocks total). Level at each axis as follows: Vertical, Traverse and Longitudinal: 50m/s ² . Device is secured via pins.
Solderability	EIA/IPC/JEDEC J-STD-002, Test A1	Parts are baked for 4 hours at a temperature of 155°C, within 72 hours they are dipped in flux for 10 seconds. Followed by dipping the parts in a solder pot at 255°C ±5°C for 5 seconds (96SC tin/silver/copper)
Solder Heat	JEDEC JESD22-B106	The test sample is subjected to a molten solder bath at 270°C ±5°C for 7 +2/-0 seconds (96SC tin/silver/copper). The leads are dipped in the solder bath to within 1mm of the device body.
Solder Heat (Hand)	MIL-STD-202 Method 210, Condition A	The soldering iron is heated to 350°C ± 10°C and applied to the terminations for a duration of 4 to 5 seconds.
Solvent cleaning	Resistance to cleaning agents	Solvent – Novec 71IPA & Topklean EL-20A. Pulsed ultrasonic immersion 45°C- 65°C
Solvent Resistance	MIL-STD-883 Method 2015	The parts and the bristle portion of the brush are immersed in Isopropanol for a minimum of 1 minute. The parts are brushed 3 times, after the third time the parts are blown dry and inspected.
Lead Integrity (Adhesion)	MIL-STD-883 Method 2025	Leads are bent through 90° until a fracture occurs.
Lead Integrity (Fatigue)	MIL-STD-883 Method 2004, Condition B,	The leads are bent to an angle of 15°. Each lead is subjected to 3 cycles.
Lead Integrity (Tension/Pull)	MIL-STD-883 Method 2004, Condition A,	Pull of 0.227kg applied for 30 seconds. The force is then increased until the pins snap.

EMC/ESD STANDARDS

Conducted emissions	EN55032/FCC class B
Radiated emissions	EN55032/FCC class B
ESD immunity	IEC/EN 61000-4-2, Level 1, criteria A
Radiated, radio-frequency, electromagnetic field immunity	IEC/EN61000-4-3, 10V/m perf criteria A 10V/m 80-1000MHz 3V/m 1.4-2.0GHz 1V/m 2.0-2.7GHz All 80% 1kHz am mod all perf criteria A
EFT/burst	IEC/EN61000-4-4, 2kV, perf criteria A
Surge immunity	IEC/EN61000-4-5, 1kV perf criteria A
Conducted field immunity	IEC/EN61000-4-6, 10 Vrms 0.15-80MHz 80% 1kHz am mod perf criteria A
Power frequency magnetic field immunity	IEC/EN61000-4-8, 50Hz/60Hz 30 A/m perf criteria A
Harmonic current emissions	IEC/EN61000-3-2
Voltage changes, voltage fluctuations and flicker	IEC/EN61000-3-3
Voltage dips, short interruptions and variations	IEC/EN61000-4-11, 100% for 20ms, 60% for 200ms, 30% for 500ms and 100% for 5s perf criteria A-A-A-C.

PART NUMBER STRUCTURE

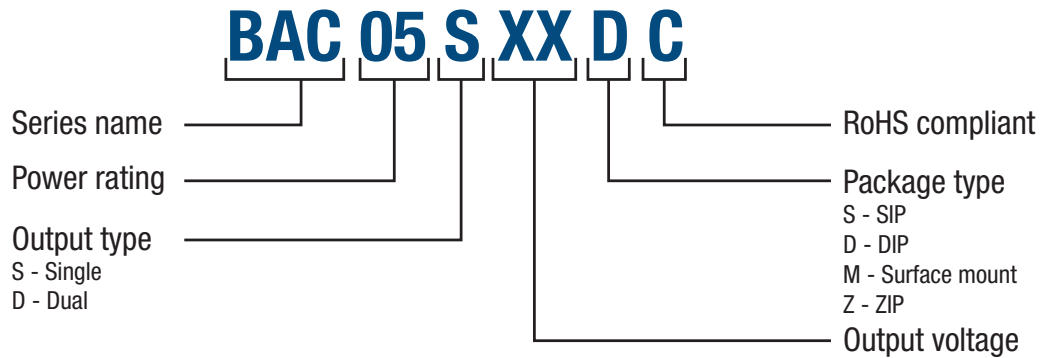

CHARACTERISATION TEST METHODS

Ripple & Noise Characterisation Method

Ripple and noise measurements are performed with the following test configuration.

C1 10 μ F electrolytic capacitor

Differential Mode Noise Test Schematic

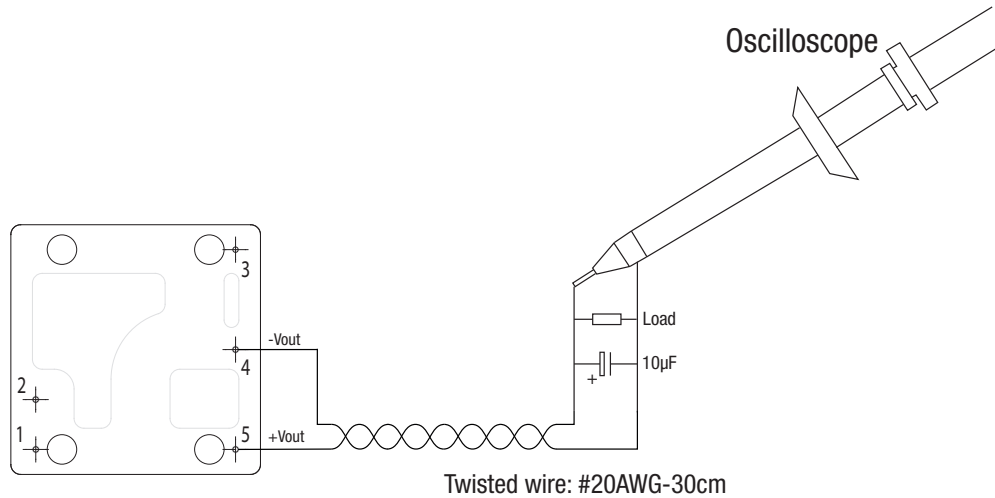

APPLICATION NOTES

Output Capacitance and start-up times

The BAC05 series does not require output capacitors to meet datasheet specification. To meet datasheet specification, output capacitance should not exceed:

Part No.	Maximum Load Capacitance	Load capacitance to meet start-up	Start-up times with maximum load capacitance	Start up times with 10 μ F
	μ F	μ F	ms	ms
BAC05S05DC	1000	10	340	140
BAC05S12DC	330	10	630	210
BAC05S24DC	220	10	1900	430

When operational in an application will operate down to -40°C . For start-up below nominal input voltage ≤ 115 VAC, at very low temperatures, please refer the temperature derating graphs.

APPLICATION NOTES (Continued)

Minimum Load

The minimum load to meet full datasheet specification is 10% of the full rated load across the specified input voltage range.

Reconditioning

This series contains electrolytic capacitors, which require reconditioning if the product is stored non-powered for more than 2 years from the date of manufacture. To recondition the capacitors, an AC input voltage should be applied with output loading for 10 minutes. For further information please contact Murata.

EFFICIENCY VS LOAD

BAC05S05DC

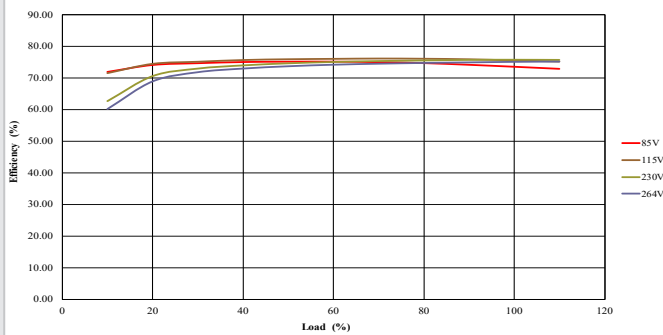

BAC05S12DC

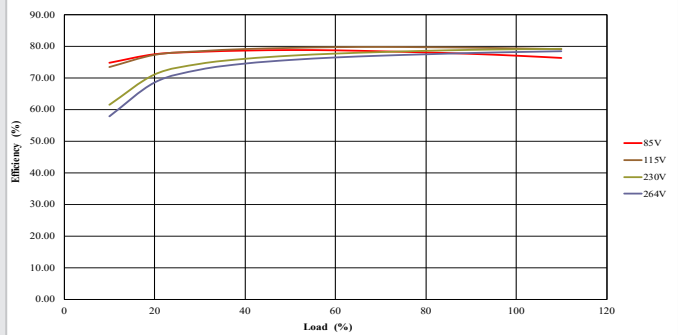

BAC05S24DC

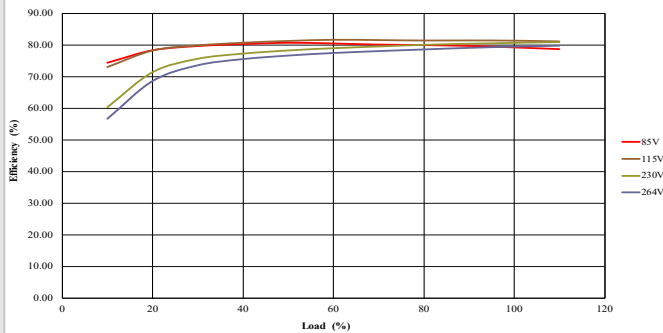

TEMPERATURE DERATING - PART OPERATIONAL

BAC05S05DC

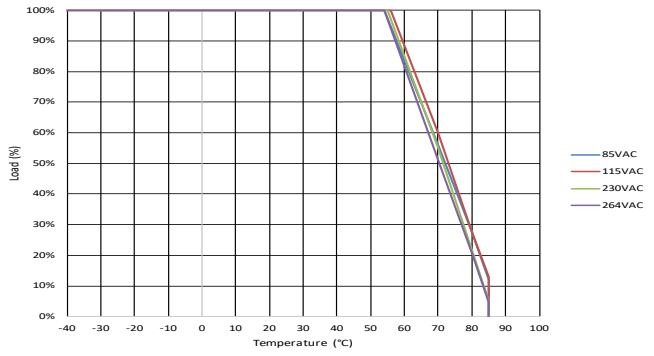

BAC05S12DC

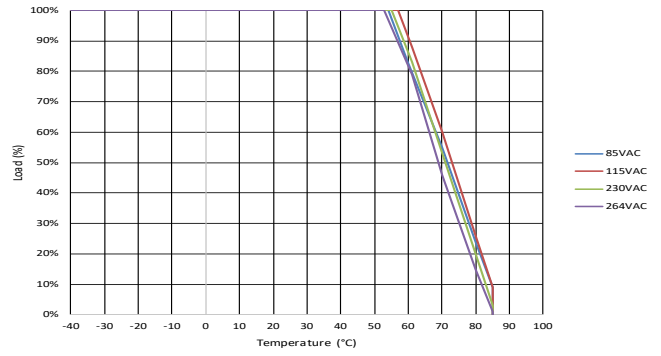

BAC05S24DC

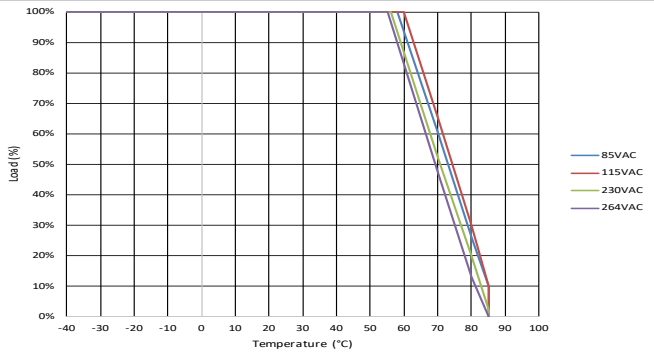

TEMPERATURE DERATING - COLD STARTUP

BAC05S05DC

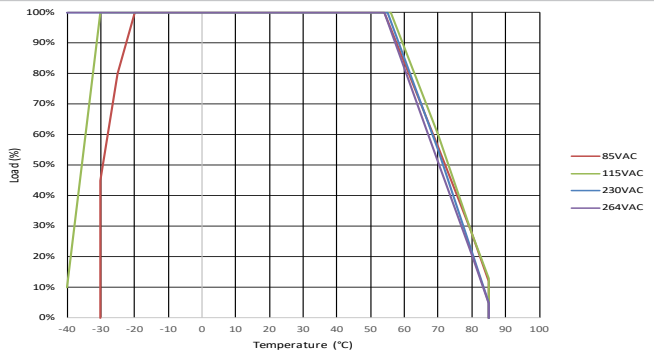

BAC05S12DC

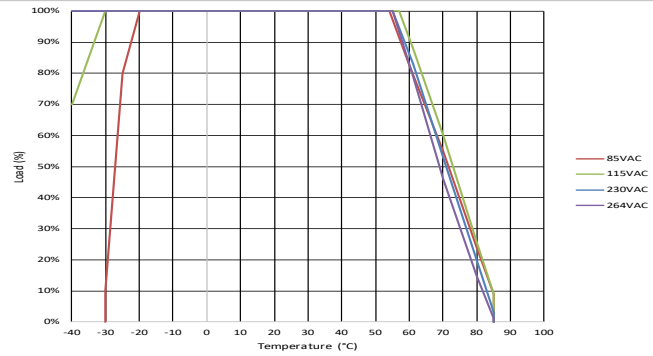

BAC05S24DC

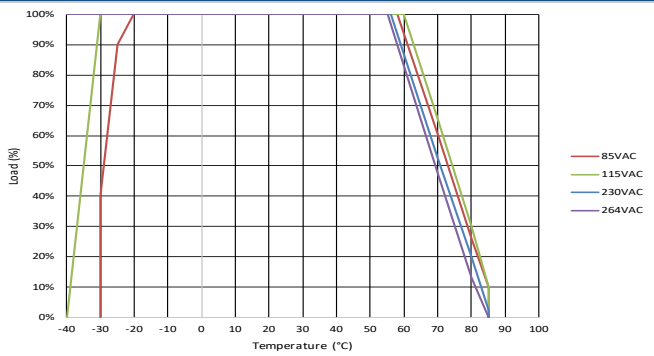

PACKAGE SPECIFICATIONS

MECHANICAL DIMENSIONS

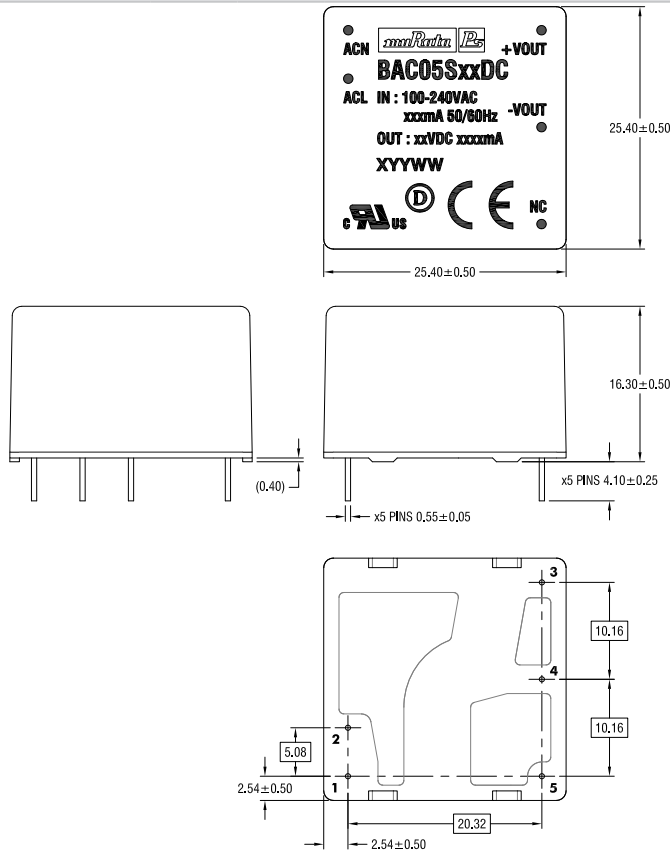

All dimensions in mm
Unless otherwise specified all pins within ± 0.30 of true position.

Weight: 18g

PIN CONNECTIONS

Pin	Function
1	AC(N)
2	AC(L)
3	NC
4	-Vout
5	+Vout

TUBE OUTLINE DIMENSIONS

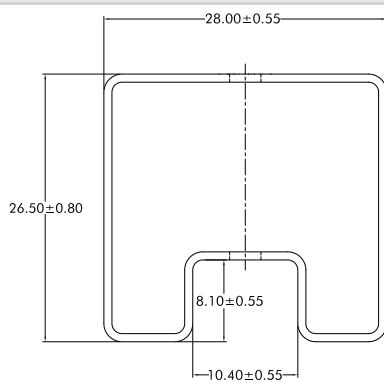

Unless otherwise specified all dimensions in mm.
Tube Length : 550mm \pm 2.0.

Tube Quantity : 20

RECOMMENDED FOOTPRINT DETAILS

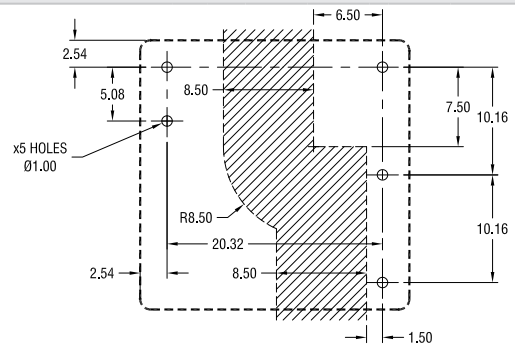

The isolation barrier shown must not have any copper traces even on internal layers. This is to avoid compromising the creepage and clearance distance. PCB layouts must take into consideration the required clearance and creepage requirements to maintain the clearance and creepage of the isolation barrier. All dimensions in mm.

DISCLAIMER

Unless otherwise stated in the datasheet, all products are designed for standard commercial and industrial applications and NOT for safety-critical and/or life-critical applications.

Particularly for safety-critical and/or life-critical applications, i.e. applications that may directly endanger or cause the loss of life, inflict bodily harm and/or loss or severe damage to equipment/property, and severely harm the environment, a prior explicit written approval from Murata is strictly required. Any use of Murata standard products for any safety-critical, life-critical or any related applications without any prior explicit written approval from Murata shall be deemed unauthorised use.

These applications include but are not limited to:

- Aircraft equipment
- Aerospace equipment
- Undersea equipment
- Power plant control equipment
- Medical equipment
- Transportation equipment (automobiles, trains, ships, etc.)
- Traffic signal equipment
- Disaster prevention / crime prevention equipment
- Data Processing equipment

Murata makes no express or implied warranty, representation, or guarantee of suitability, fitness for any particular use/purpose and/or compatibility with any application or device of the buyer, nor does Murata assume any liability whatsoever arising out of unauthorised use of any Murata product for the application of the buyer. The suitability, fitness for any particular use/purpose and/or compatibility of Murata product with any application or device of the buyer remain to be the responsibility and liability of the buyer.

Buyer represents and agrees that it has all the necessary expertise to create and implement safeguards that anticipate dangerous consequences of failures, monitor failures and their consequences, lessen the likelihood of failures that might cause harm, and take appropriate remedial actions. Buyer will fully indemnify and hold Murata, its affiliated companies, and its representatives harmless against any damages arising out of unauthorised use of any Murata products in any safety-critical and/or life-critical applications.

Remark: Murata in this section refers to Murata Manufacturing Company and its affiliated companies worldwide including, but not limited to, Murata Power Solutions.



This product is subject to the following [operating requirements](#) and the [Life and Safety Critical Application Sales Policy](#):

Refer to: <https://www.murata.com/en-eu/products/power/requirements>

Murata Power Solutions (Milton Keynes) Ltd. makes no representation that the use of its products in the circuits described herein, or the use of other technical information contained herein, will not infringe upon existing or future patent rights. The descriptions contained herein do not imply the granting of licenses to make, use, or sell equipment constructed in accordance therewith. Specifications are subject to change without notice.

© 2023 Murata Power Solutions (Milton Keynes) Ltd.