



Typical Unit

### FEATURES

- Efficiency up to 89% @ 72Vin, 12Vout
- Ultra-wide input range: 16V-160V
- Output voltage: 12V, 24V or 54V
- Vout trim
- Output power 150W
- Quarter-Brick Package: 61.21x39.62x13 mm  
2.41x1.56x0.51 inches
- OVP, OCP, OTP
- Positive or Negative Remote ON/OFF
- Operating Baseplate Temperature range  
-40°C to +100°C
- 4242VDC input to output isolation, reinforced
- Hold Up Time (10-30mS, with external Cap)
- UVLO Set up (resistor programmable)
- Meets requirements for EN50155

### SAFETY FEATURES

- Reinforced insulation
- UL/IEC 60950-1, 2nd Edition
- CAN/CSA C22.2 60950-1, 2nd edition
- RoHS compliant

Output Voltage (V)	Output Current (A)	Input Voltage Range (V)
12	12.5	16-160
24	6.25	16-160
54	2.80	16-160

Optimized for harsh environments in industrial/railway applications, the IRQ-W80 DC-DC converter series offer regulated outputs in an industry-standard quarter brick fully encased package.

### PRODUCT OVERVIEW

The IRQ-W80 series of isolated, regulated converter modules deliver an impressive 150W output power from an ultra-wide 10:1 input voltage range, complying with the 24V to 110V input battery voltages including transients as per EN50155 (2017) standard. The converter comes in a fully encased industry standard quarter brick package offering astonishing efficiencies. The fully isolated (4242Vdc) IRQ-W80 series features a 16 to 160 Volt DC input voltage range. Typical applications include industrial, railway and transportation.

The IRQ-W80 is an isolated power converter and fixed frequency operations means excellent efficiencies of up to 89%. A wealth of electronic protection features include input under voltage lockout, output over voltage protection, output current limit, short circuit hiccup, Vout overshoot, and over temperature shutdown.

The IRQ-W80 series is designed to meet all UL and IEC emissions and safety certifications.

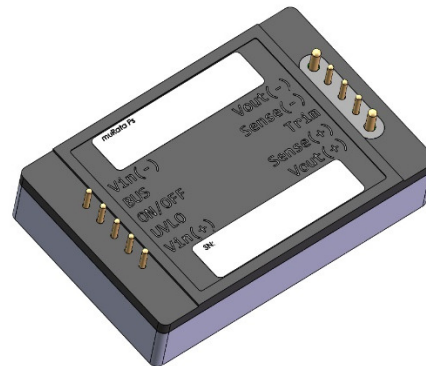

Encapsulated Quarter-Brick



PERFORMANCE SPECIFICATIONS SUMMARY AND ORDERING GUIDE [1] [2]													
Root Model [1]	Output							Input				Efficiency	Package
	V <sub>out</sub> (V)	I <sub>out</sub> (A, max.)	Power (W)	Ripple & Noise (mV pk-pk)		Regulation [3] (max.)		V <sub>in</sub> Nom. (V)	V <sub>in</sub> Range (V)	I <sub>in</sub> , no load (mA)	I <sub>in</sub> , full load (A)		
				Typ.	Max.	Line	Load						
IRQ-12/12.5-W80	12	12.5	150	100	160	±0.5%	±0.5%	72	16-160	60	12	89%	61.21 x 39.62 x 13
IRQ-24/6.25-W80	24	6.25	150	100	200	±0.25%	±0.25%	72	16-160	70	12	89%	61.21 x 39.62 x 13
IRQ-54/2.8-W80	54	2.80	150	400	500	±0.25%	±0.25%	72	16-160	70	12	89%	61.21 x 39.62 x 13

**Notes:**

- [1] Please refer to the Part Number Structure when ordering.
- [2] All specifications are at nominal line voltage and full load, +25°C unless otherwise noted. See detailed specifications. Output capacitors are 1µF ceramic multilayer in parallel with 10µF. I/O caps are necessary for our test equipment and may not be needed for your application.
- [3] Regulation specifications describe output voltage deviations from a nominal/midpoint value to either extreme (50% load step).

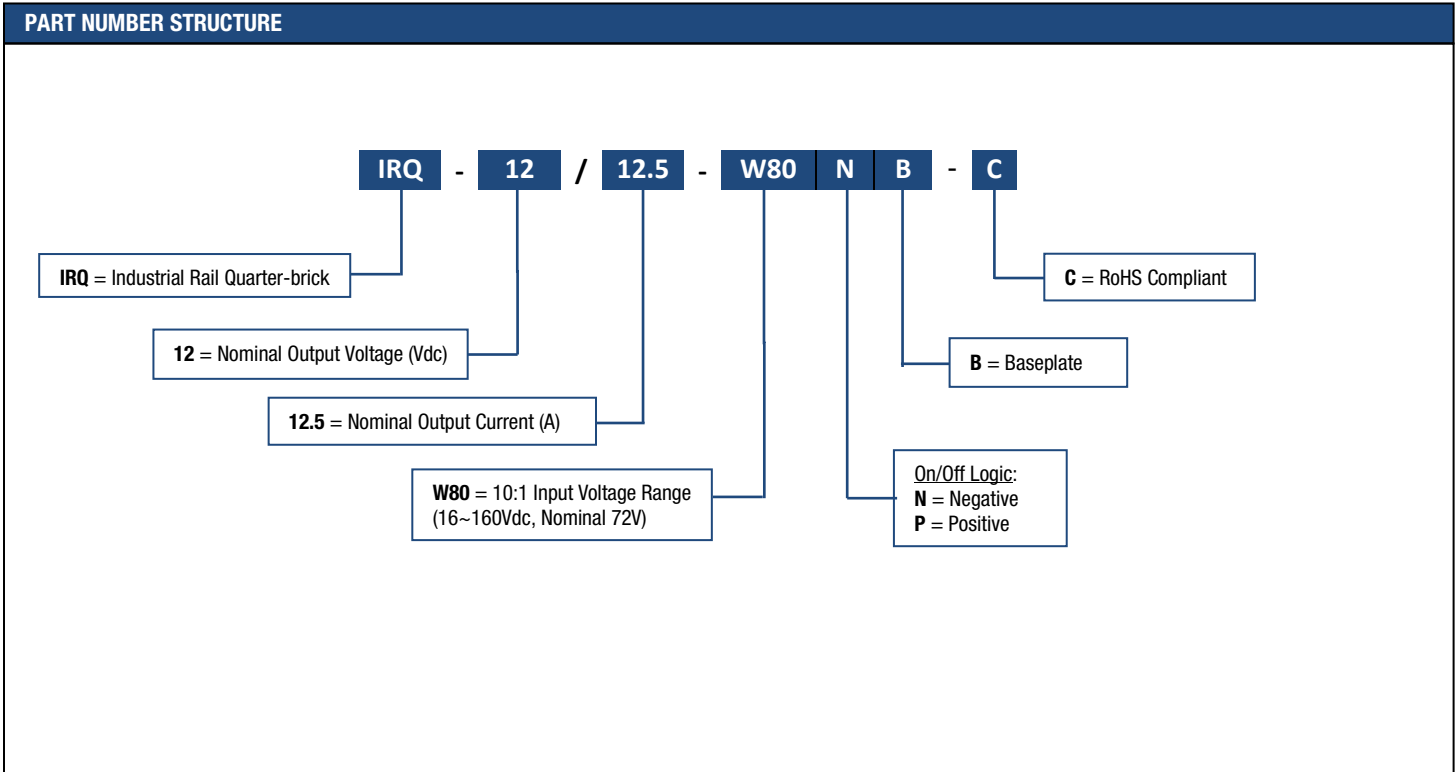

Please click [here](#) to view DCAN-71, User Guide for the MP-QW80EVAL-01 Evaluation Board.

### FUNCTIONAL SPECIFICATIONS: IRQ-12/12.5-W80

ABSOLUTE MAXIMUM RATINGS	NOTES AND CONDITIONS	MIN.	TYP.	MAX.	UNITS
<b>Input Voltage</b>					
Non-Operating	Continuous	0		175	Vdc
Operating	Continuous	16		160	Vdc
Transient Operating	100mS			170	Vdc
Operating Ambient Temperature		-40		85	°C
Operating Baseplate Temperature		-40		100	°C
Storage Temperature		-55		125	°C
Altitude				3000	m
Input/Output Isolation Voltage				4242	Vdc
Voltage at ON/OFF input pin		0		15	Vdc
General conditions for device under Test unless otherwise specified: Ambient temperature +25°C; Vin typical; Vout nominal load; Encapsulated Package; With 1μF&10μF capacitors across output pins.					
<b>INPUT CHARACTERISTICS</b>					
Operating Input Voltage Range		16	72	160	Vdc
<b>Input Under-Voltage Lockout</b>					
Turn-On Voltage Threshold		14.0	15.0	16.0	Vdc
Turn-Off Voltage Threshold		11.0	12.0	13.0	Vdc
Lockout Voltage Hysteresis			3		Vdc
Maximum Input Current	Full Load, Vin=16V			12	A
No-Load Input Current	Vin=72V		40	60	mA
Disabled Input Current (N suffix)			10	15	mA
Disabled Input Current (Blank suffix)			10	15	mA
Input Reflected Ripple Current	RMS thru 220μF/250V, 12μF across source, 33μF/250V external capacitors across input pins		100	150	mA
Input Terminal Ripple Current	RMS, 20MHz bandwidth		4.5	5	A
Recommended Input Fuse	See Technical Notes		-		A
Recommended External Input Capacitance	See Figure 4 in the Technical Notes.		220		μF
Recommended BUS Capacitance	2pcs 120μF/250Vdc and MPN is EKXJ251ELL121ML25S. See Figure 4.		240		μF
Inrush Current (I <sub>rt</sub> )			25	30	A'S
<b>OUTPUT CHARACTERISTICS</b>					
Total Output Power	See Derating		150	150	W
Output Voltage Set Point	Vin=Nominal, Io=0A, Ta=25°C	11.88	12	12.12	Vdc
<b>Output Voltage Regulation</b>					
Over Load	Vin=72V, Iout from Min to Max		±0.5		%
Over Line	Iout=Full load, Vin from Min to Max		±0.5		%
Over Temperature	Vin=72V, Ta=-40°C to 85°C		±0.004	±0.01	mV
Total Output Voltage Range	Over sample, line, load, temperature & life	11.64		12.36	Vdc
<b>Output Voltage Ripple and Noise</b>					
Peak-to-Peak	Full Load, 1μF ceramic, 10μF tantalum		100	160	mVp-p
RMS	Full Load, 1μF ceramic, 10μF tantalum		30	50	mVrms
Operating Output Current Range		0	12.5	12.5	A
Output DC Current-Limit Inception	Output Voltage 10% Low	14	18	22	A
Output Capacitance	Nominal Vout at full load (CR load)	0		2200	μF
<b>Programmable Undervoltage Lockout:</b>					
<b>24Vin : Ruvlo = open</b>					
	Vin_OFF	11.0	12.0	13.0	Vdc
	Vin_ON	14.0	15.0	16.0	Vdc
<b>36Vin : Ruvlo = 20.5kΩ</b>					
	Vin_OFF	19.5	20.5	21.5	Vdc
	Vin_ON	22.5	23.5	24.5	Vdc
<b>48Vin : Ruvlo = 10.7kΩ</b>					
	Vin_OFF	28.0	29.0	30.0	Vdc
	Vin_ON	31.0	32.0	33.0	Vdc
<b>72Vin : Ruvlo = 5.9kΩ</b>					
	Vin_OFF	41.5	43.0	44.5	Vdc
	Vin_ON	44.5	46.0	47.5	Vdc
<b>96Vin : Ruvlo = 3.74kΩ</b>					
	Vin_OFF	58.5	60.5	62.5	Vdc
	Vin_ON	61.8	63.8	65.8	Vdc
<b>110Vin : Ruvlo = 3.48kΩ</b>					
	Vin_OFF	62.3	64.3	66.3	Vdc
	Vin_ON	65.3	67.3	69.3	Vdc
<b>EFFICIENCY</b>					
100% Load	Vin=72V; Details see Figures		89		%
50% Load	Vin=72V; Details see Figures		88		%

### FUNCTIONAL SPECIFICATIONS: IRQ-12/12.5-W80

DYNAMIC CHARACTERISTICS						
<b>Output Voltage During Load Current Transient</b>						
Step Change in Output Current (0.1A/uS)	50% to 75% to 50% Iout max, 1uF+10uF load cap		250	400	mV	
Settle Time	To within 1% Vout nom		75	150	uS	
<b>Turn-On Transient</b>						
Start-up Time, From ON/OFF Control	To Vout=90% nominal			460	mS	
Start-up Time, From Input	To Vout=90% nominal			460	mS	
Rise Time	Time from 10% to 90% of nominal output voltage			25	mS	
Output Voltage Overshoot				2	%	
ISOLATION CHARACTERISTICS		NOTES AND CONDITIONS	MIN.	TYP.	MAX.	UNITS
<b>Insulation Safety Rating</b>						
Input to Output				Reinforced		
Input to Baseplate				4242		Vdc
Output to Baseplate				2250		Vdc
Output to Baseplate				2250		Vdc
Isolation Resistance	Input/Output			20		MΩ
Isolation Capacitance	Input/Output			750		pF
TEMPERATURE LIMITS FOR POWER DERATING CURVES						
<b>Semiconductor Junction Temperature</b>						
Semiconductor Junction Temperature				Tjmax-25		°C
<b>Board Temperature</b>						
Board Temperature	UL rated max operating temp 130°C			130		°C
<b>Transformer/Inductor Temperature</b>						
Transformer/Inductor Temperature				130		°C
FEATURE CHARACTERISTICS						
<b>Switching Frequency</b>						
Switching Frequency			190	210	230	kHz
<b>ON/OFF Control (Blank suffix)</b>						
Off-State Voltage			0		0.7	V
On-State Voltage	Open the ON/OFF pin = ON		2		15	V
<b>ON/OFF Control (N suffix)</b>						
Off-State Voltage	Open the ON/OFF pin = OFF		2		15	V
On-State Voltage			0		0.7	V
<b>ON/OFF Control Current (Either Option)</b>						
Current thru ON/OFF pin	Von/off=0V			1	2	mA
Current thru ON/OFF pin	Von/off=15V				1	mA
<b>Remote Sense Compensation</b>						
Remote Sense Compensation				10		%
<b>Output Voltage Trim Range</b>						
Output Voltage Trim Range	Pout<=Max rated power		-10		10	%
<b>Trim Up Equations</b>						
Trim Up Equations	Please see TRIM functions in Technical Notes					
<b>Trim Down Equations</b>						
Trim Down Equations	Please see TRIM functions in Technical Notes					
<b>Output Over-Voltage Protection</b>						
Output Over-Voltage Protection	Hiccup mode; over full temp range; % of nominal Vout		115	125	150	%
<b>Over-Temperature Shutdown</b>						
<b>With Baseplate</b>						
With Baseplate				125		°C
<b>Restart Hysteresis</b>						
Restart Hysteresis				6		°C
RELIABILITY/SAFETY/ENVIRONMENTAL						
<b>Safety</b>						
Safety	Certified to UL 60950-1, CAN/CSA C22.2 60950-1, 2nd edition			Yes		
<b>Calculated MTBF</b>						
Calculated MTBF	Per Telcordia SR332, Issue 2, Method 1, Class 1			1.48		MHrs
<b>Conducted Emissions</b>						
Conducted Emissions	External filter is required, see Technical Notes			EN55011 CLASS A		
MECHANICAL						
<b>Outline Dimensions</b>						
Outline Dimensions			2.41 x 1.56 x 0.512			Inches
(Please refer to outline drawing)	L x W x H		61.21 x 39.62 x 13			mm
<b>Weight</b>						
Weight				3		Ounces
				90		Grams
<b>Through Hole Pin Diameter</b>						
Through Hole Pin Diameter			0.04 & 0.06			Inches

**TYPICAL PERFORMANCE DATA: IRQ-12/12.5-W80**

**IRQ-12/12.5-W80 Efficiency vs Pout**

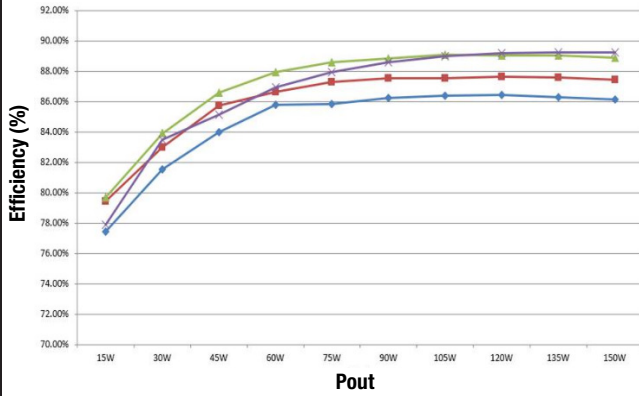

**IRQ-12/12.5-W80 Power Dissipation vs Load**

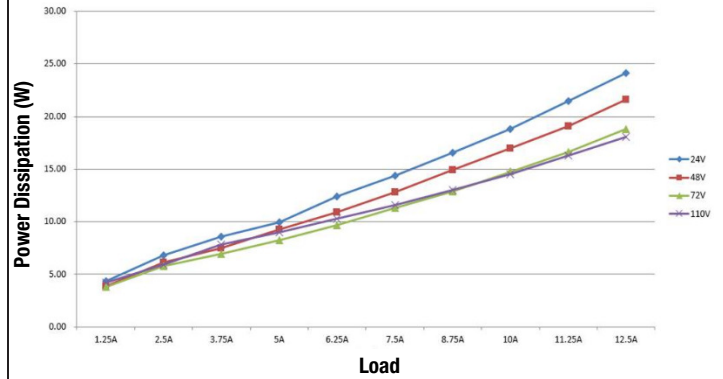

**IRQ-12/12.5-W80 Temperature Derating**

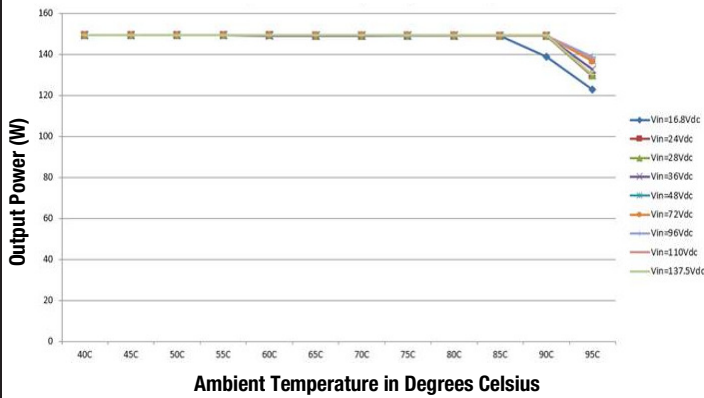

**Turn On Transient VS Enable @ 72V with Full load with 2200uF load caps**

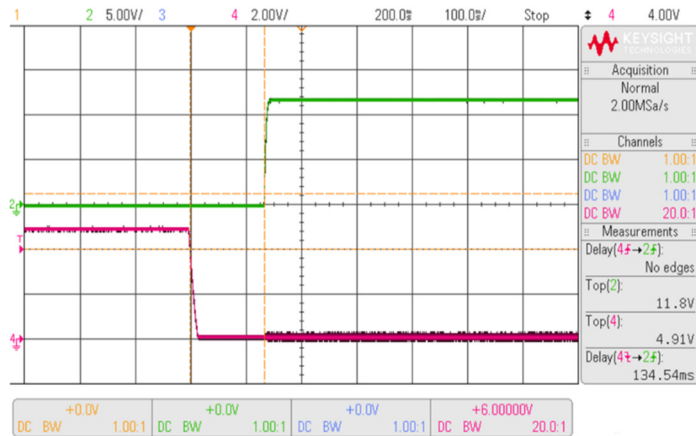

**Turn On Transient VS Vin @ 72V with Full load with 2200uF load caps**

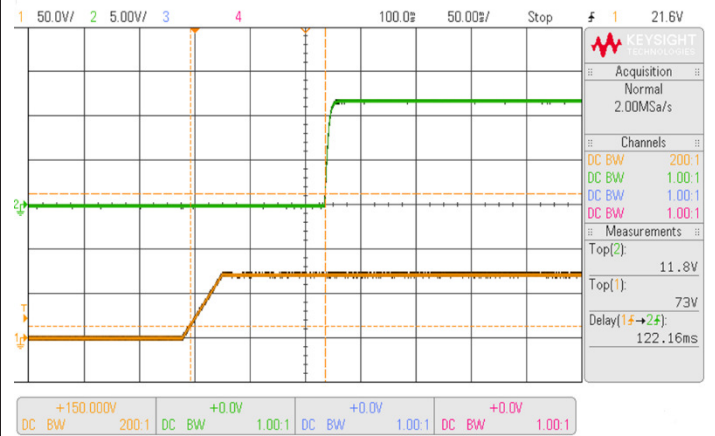

**TYPICAL PERFORMANCE DATA: IRQ-12/12.5-W80**

Output voltage response to step-change in load current  
(50%-75%-50% of full load; di/dt = 0.1A/ $\mu$ s)

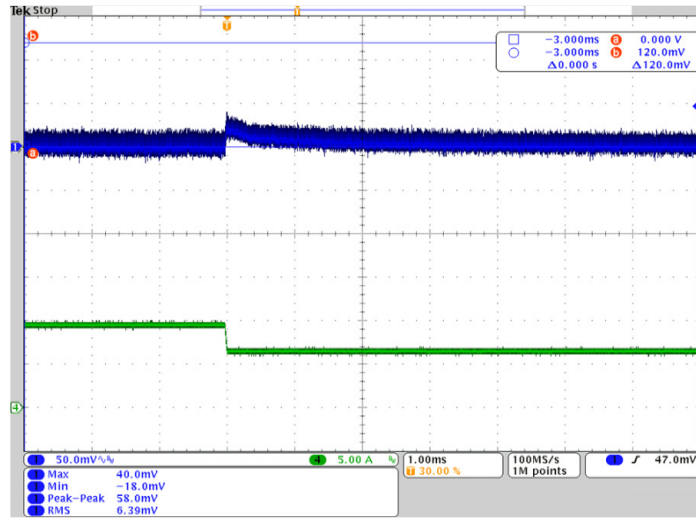

Output voltage response to step-change in load current  
(50%-75%-50% of full load; di/dt = 0.1A/ $\mu$ s)

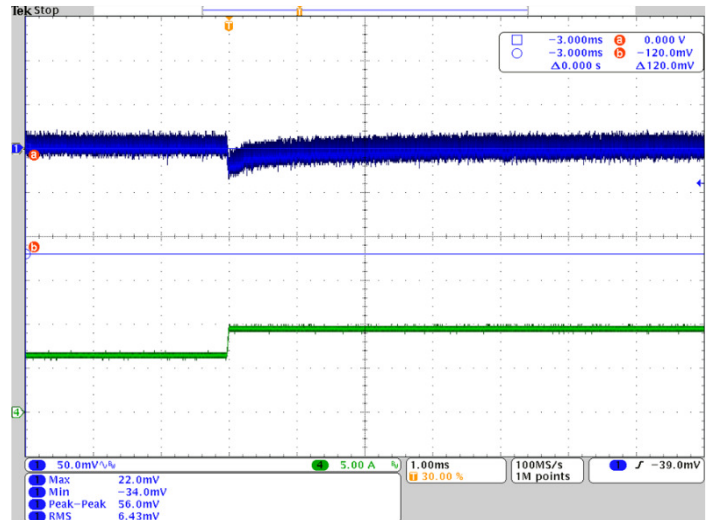

Output voltage response to step-change in load current  
(50%-75%-50% of full load; di/dt = 0.1A/ $\mu$ s)

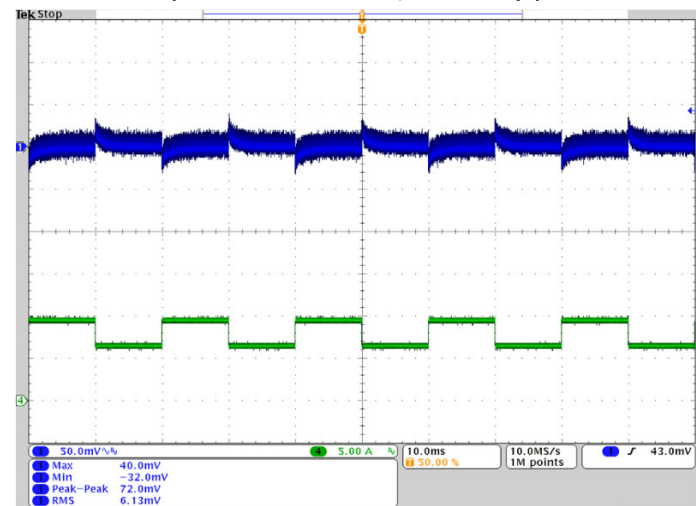

Output Ripple@20MHz BW,  
Vin = 72Vdc, Full Load with 2200uF output capacitance

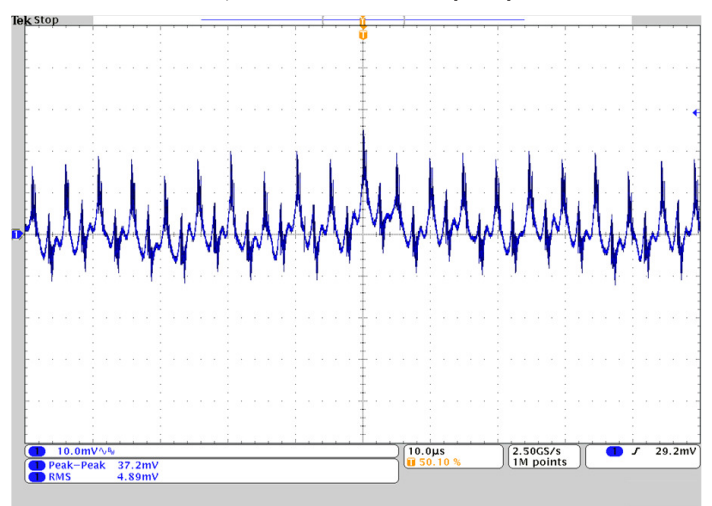



### FUNCTIONAL SPECIFICATIONS: IRQ-24/6.25-W80

ABSOLUTE MAXIMUM RATINGS	NOTES AND CONDITIONS	MIN.	TYP.	MAX.	UNITS
<b>Input Voltage</b>					
Non-Operating	Continuous	0		175	Vdc
Operating	Continuous	16		160	Vdc
Transient Operating	100mS	14.4		168	Vdc
Operating Ambient Temperature		-40		85	°C
Operating Baseplate Temperature		-40		100	°C
Storage Temperature		-55		125	°C
Altitude				3000	m
Input/Output Isolation Voltage				4242	Vdc
Voltage at ON/OFF input pin		0		15	Vdc
General conditions for device under Test unless otherwise specified: Ambient temperature +25°C; Vin typical; Vout nominal load; Encapsulated Package; With 1µF&10µF capacitors across output pins.					
<b>INPUT CHARACTERISTICS</b>					
Operating Input Voltage Range		16	72	160	Vdc
Input Under-Voltage Lockout					
Turn-On Voltage Threshold		13.0	14.0	15.0	Vdc
Turn-Off Voltage Threshold		11.0	12.0	13.0	Vdc
Lockout Voltage Hysteresis			2		Vdc
Maximum Input Current	Full Load, Vin=16V			12	A
No-Load Input Current	Vin=72V		60	70	mA
Disabled Input Current (N suffix)			10	15	mA
Disabled Input Current (Blank suffix)			10	15	mA
Input Reflected Ripple Current	RMS thru 220µF/250V, 12µF across source, 33µF/250V external capacitors across input pins		100	150	mA
Input Terminal Ripple Current	RMS, 20MHz bandwidth		4.0	4.5	A
Recommended Input Fuse	See Technical Notes		--		A
Recommended External Input Capacitance	See Figure 4 in the Technical Notes.		220		µF
Recommended BUS Capacitance	2pcs 120µF/250Vdc and MPN is EKXJ251ELL121ML25S. See Figure 4.		240		µF
Inrush Current (I <sub>rt</sub> )			25	30	A <sup>2</sup> S
<b>OUTPUT CHARACTERISTICS</b>					
Total Output Power	See Derating		150	150	W
Output Voltage Set Point	Vin=Nominal, Io=0A, Ta=25°C	23.76	24	24.24	Vdc
Setting Accuracy within :	(measured @ 50% Load)		1		%Vo nom
Output Voltage Regulation					
Over Load	Vin=72V, Iout from Min to Max		±0.25		%
Over Line	Iout=Full load, Vin from Min to Max		±0.25		%
Over Temperature	Vin=72V, Ta=-40°C to 85°C		±0.004	±0.02	mV
Total Output Voltage Range	Over sample, line, load, temperature & life	23.28		24.72	Vdc
Output Voltage Ripple and Noise	20MHz bandwidth				
Peak-to-Peak	Full Load, 1µF ceramic, 10µF tantalum		100	200	mVp-p
RMS	Full Load, 1µF ceramic, 10µF tantalum		30	50	mVrms
Operating Output Current Range		0	6.25	6.25	A
Output DC Current-Limit Inception	Output Voltage 10% Low	7.5	9	11	A
Output Capacitance	Nominal Vout at full load (CR load)	0		1500	µF
Programmable Undervoltage Lockout:	(via R uvlo)				
24Vin : Ruvlo = open	Vin_OFF	11.0	12.0	13.0	Vdc
	Vin_ON	13.0	14.0	15.0	Vdc
36Vin : Ruvlo = 12.7kΩ	Vin_OFF	21.0	22.0	23.0	Vdc
	Vin_ON	23.0	24.0	25.0	Vdc
48Vin : Ruvlo = 6.98kΩ	Vin_OFF	29.0	30.0	31.0	Vdc
	Vin_ON	31.0	32.0	33.0	Vdc
72Vin : Ruvlo = 3.92kΩ	Vin_OFF	42.5	44.0	45.5	Vdc
	Vin_ON	44.5	46.0	47.5	Vdc
96Vin : Ruvlo = 2.49kΩ	Vin_OFF	61.3	62.8	64.3	Vdc
	Vin_ON	63.3	64.8	66.3	Vdc
110Vin : Ruvlo = 2.37kΩ	Vin_OFF	63.5	65.0	66.5	Vdc
	Vin_ON	65.5	67.0	68.5	Vdc

### FUNCTIONAL SPECIFICATIONS: IRQ-24/6.25-W80

EFFICIENCY						
100% Load	Vin=24V; Details see Figures		85.5		%	
100% Load	Vin=110V; Details see Figures		89		%	
DYNAMIC CHARACTERISTICS						
Output Voltage During Load Current Transient						
Step Change in Output Current (0.1A/uS)	Iout 50-75-50% nom, within 1% of Vout		150		uS	
Peak deviation			±250	±350	mV	
Turn-On Transient						
Start-up Time, From ON/OFF Control	To Vout=90% nominal		50	460	mS	
Start-up Time, From Input	To Vout=90% nominal		150	460	mS	
Rise Time	Time from 10% to 90% of nominal output voltage			25	mS	
Output Voltage Overshoot				2	%	
ISOLATION CHARACTERISTICS		NOTES AND CONDITIONS	MIN.	TYP.	MAX.	UNITS
Insulation Safety Rating				Reinforced		
Input to Output				4242		Vdc
Input to Baseplate				2250		Vdc
Output to Baseplate				2250		Vdc
Isolation Resistance	Input/Output			20		MΩ
Isolation Capacitance	Input/Output			750		pF
TEMPERATURE LIMITS FOR POWER DERATING CURVES						
Semiconductor Junction Temperature				Tjmax-25		°C
Board Temperature	UL rated max operating temp 130°C			130		°C
Transformer/Inductor Temperature				130		°C
FEATURE CHARACTERISTICS						
Switching Frequency		252	280	308		kHz
ON/OFF Control (Blank suffix)						
Off-State Voltage		0		0.7		V
On-State Voltage	Open the ON/OFF pin = ON	2		15		V
ON/OFF Control (N suffix)						
Off-State Voltage	Open the ON/OFF pin = OFF	2		15		V
On-State Voltage		0		0.7		V
ON/OFF Control Current (Either Option)						
Current thru ON/OFF pin	Von/off=0V			1	2	mA
Current thru ON/OFF pin	Von/off=15V				1	mA
Remote Sense Compensation				5		%
Output Voltage Trim Range	Pout<=Max rated power	-10		10		%
Trim Up Equations	Please see TRIM functions in Technical Notes					
Trim Down Equations	Please see TRIM functions in Technical Notes					
Output Over-Voltage Protection	Hiccup mode; over full temp range; % of nominal Vout	28	29	31		Vdc
Over-Temperature Shutdown						
With Baseplate				125		°C
Restart Hysteresis				6		°C
RELIABILITY/SAFETY/ENVIRONMENTAL						
Safety	Certified to UL 60950-1, CAN/CSA C22.2 60950-1, 2nd edition			Yes		
Calculated MTBF	Per Telcordia SR332, Issue 2, Method 1, Class 1			1.48		MHrs
Conducted Emissions	External filter is required, see Technical Notes			EN55011 CLASS A		
MECHANICAL						
Outline Dimensions			2.41 x 1.56 x 0.512			Inches
(Please refer to outline drawing)	L x W x H		61.21 x 39.62 x 13			mm
Weight			3			Ounces
			90			Grams
Through Hole Pin Diameter			0.04 & 0.06			Inches



### TYPICAL PERFORMANCE DATA: IRQ-24/6.25-W80

IRQ-24/6.25-W80 Efficiency vs Pout

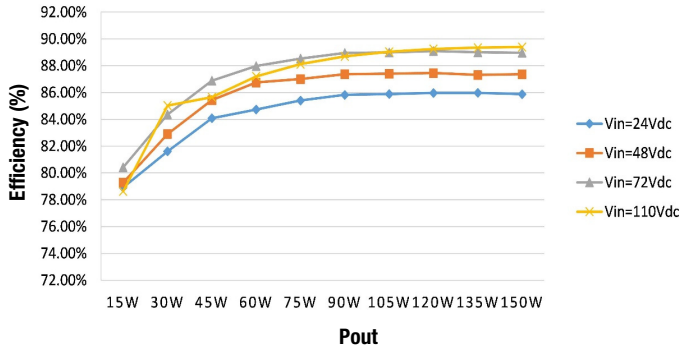

IRQ-24/6.25-W80 Power Dissipation vs Load

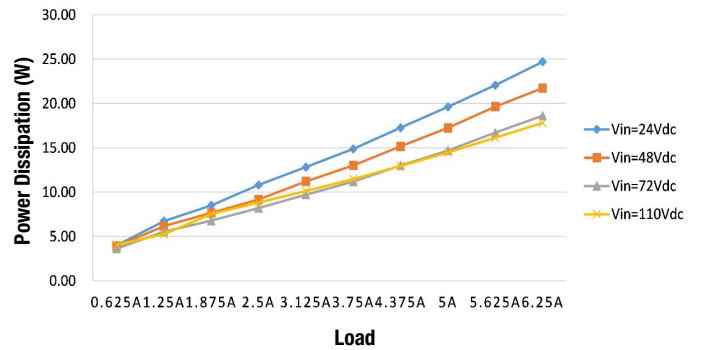

IRQ-24/6.25-W80 Temperature Derating

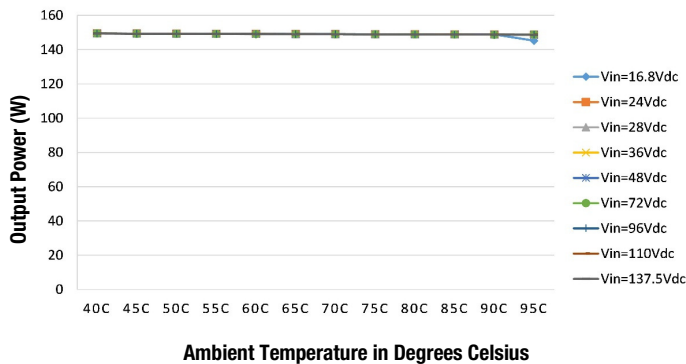

Turn On Transient VS Enable @ 72V with Full load with 1500uF load caps

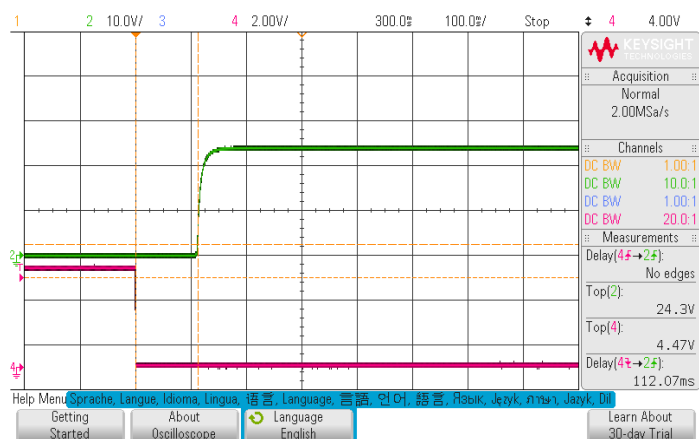

Turn On Transient VS Vin @ 72V with Full load with 1500uF load caps

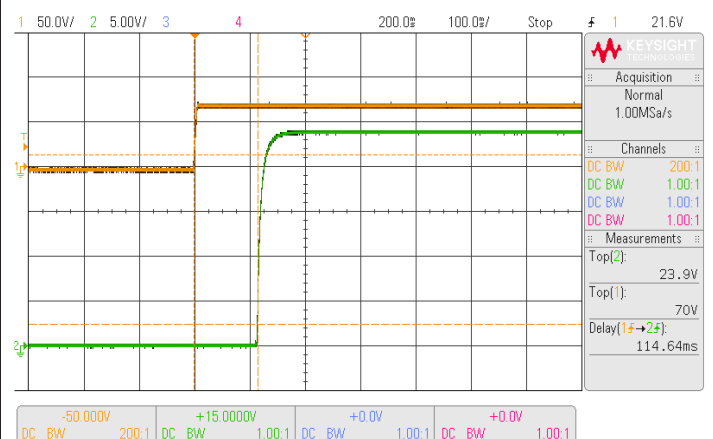

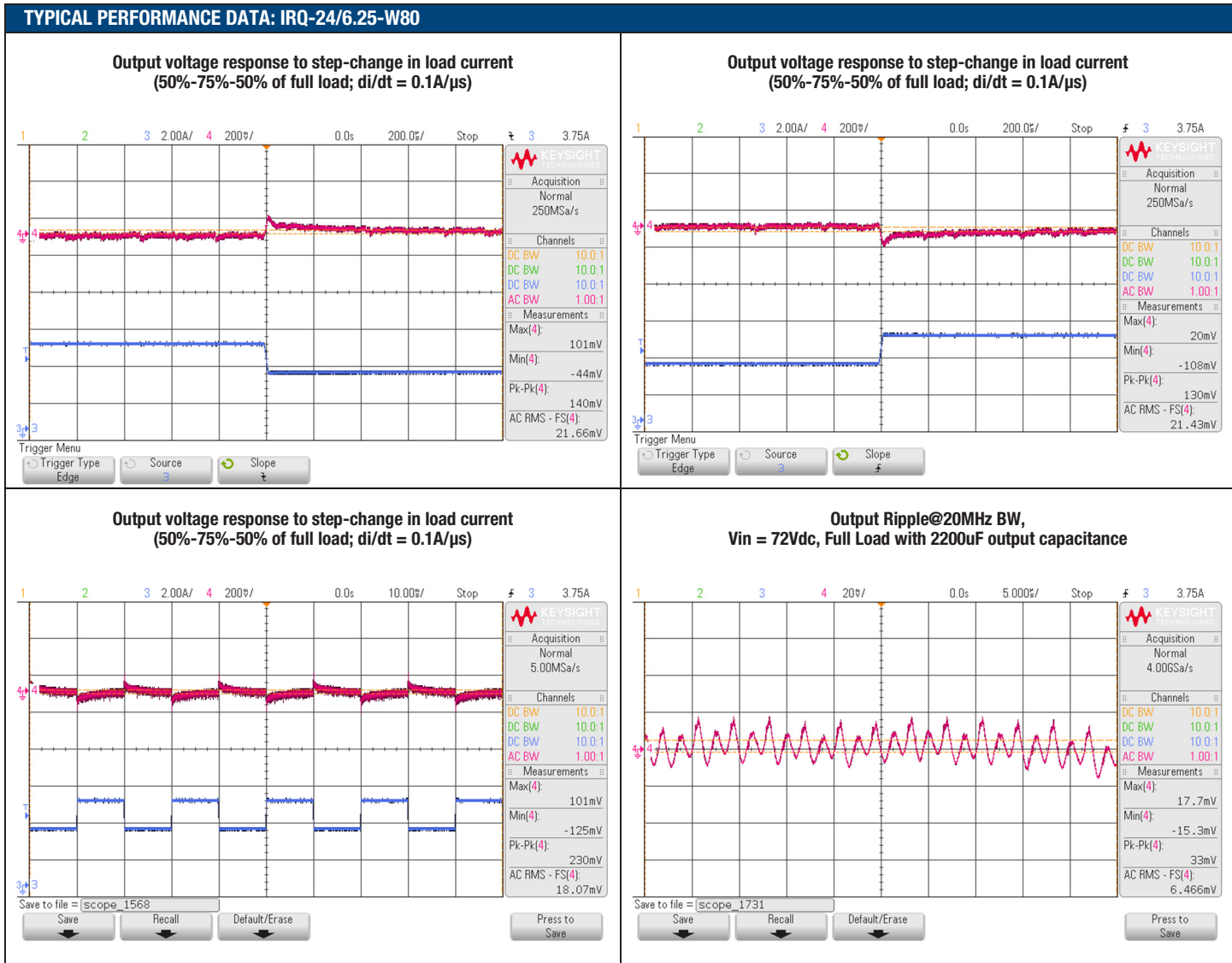

### FUNCTIONAL SPECIFICATIONS: IRQ-54/2.8-W80

ABSOLUTE MAXIMUM RATINGS	NOTES AND CONDITIONS	MIN.	TYP.	MAX.	UNITS
<b>Input Voltage</b>					
Non-Operating	Continuous	0		175	Vdc
Operating	Continuous	16		160	Vdc
Transient Operating	100mS	14.4		168	Vdc
Operating Ambient Temperature		-40		85	°C
Operating Baseplate Temperature		-40		100	°C
Storage Temperature		-55		125	°C
Altitude				3000	m
Input/Output Isolation Voltage				4242	Vdc
Voltage at ON/OFF input pin		0		15	Vdc
General conditions for device under Test unless otherwise specified: Ambient temperature +25°C; Vin typical; Vout nominal load; Encapsulated Package; With 1µF&10µF capacitors across output pins.					
<b>INPUT CHARACTERISTICS</b>					
Operating Input Voltage Range		16	72	160	Vdc
<b>Input Under-Voltage Lockout</b>					
Turn-On Voltage Threshold		13.0	14.0	15.0	Vdc
Turn-Off Voltage Threshold		10.0	12.0	13.0	Vdc
Lockout Voltage Hysteresis			2		Vdc
Maximum Input Current	Full Load, Vin=16V			12	A
No-Load Input Current	Vin=72V		60	70	mA
Disabled Input Current (N suffix)			10	15	mA
Disabled Input Current (Blank suffix)			10	15	mA
Back Ripple Current (w/filtering)	Measured at the input of module with a simulated source impedance of 12µH, 220µF, 200V, across source, 220µF, 200V external capacitors across input pins.		1200	1500	mA
Back Ripple Current (w/o filtering)			6500	7500	mA
Input Terminal Ripple Current	RMS, 20MHz bandwidth		17		mA
Short Circuit Input Current			0.06		A
Recommended Input Fuse	See Technical Notes		--		A
Recommended External Input Capacitance	See Figure 4 in the Technical Notes.		220		µF
Recommended BUS Capacitance	2pcs 120µF/250Vdc and MPN is EKXJ251ELL121ML25S. See Figure 4.		240		µF
Inrush Current (I <sup>2</sup> t)			20		A <sup>2</sup> S
<b>OUTPUT CHARACTERISTICS</b>					
Total Output Power	See Derating		150	150	W
Output Voltage Set Point	Vin=Nominal, Io=0A, Ta=25°C	53.46	54	54.54	Vdc
Setting Accuracy:	(measured @ 50% Load)		1		% Vo nom
<b>Output Voltage Regulation</b>					
Over Load	Vin=72V, Iout from Min to Max		±0.25		%
Over Line	Iout=Full load, Vin from Min to Max		±0.25		%
Temperature Coefficient	@ All Outputs:		0.02		%/°C
Total Output Voltage Range	Over sample, line, load, temperature & life	52.38		55.62	Vdc
<b>Output Voltage Ripple and Noise</b>					
Peak-to-Peak	Full Load, 1µF ceramic, 10µF tantalum		400	500	mV
RMS	Full Load, 1µF ceramic, 10µF tantalum		30	50	mV
Operating Output Current Range		0	2.8	2.8	A
Output DC Current-Limit Inception	Output Voltage 10% Low	3.3	4.1	5.5	A
Output Capacitance	Nominal Vout at full load (CR load)	0		470	µF
<b>Programmable Undervoltage Lockout:</b> (via R uvlo)					
24Vin : Ruvlo = open	Vin_OFF	11.0	12.0	13.0	Vdc
	Vin_ON	13.0	14.0	15.0	Vdc
36Vin : Ruvlo = 12.7kΩ	Vin_OFF	21.0	22.0	23.0	Vdc
	Vin_ON	23.0	24.0	25.0	Vdc
48Vin : Ruvlo = 6.98kΩ	Vin_OFF	29.0	30.0	31.0	Vdc
	Vin_ON	31.0	32.0	33.0	Vdc
72Vin : Ruvlo = 3.92kΩ	Vin_OFF	42.5	44.0	45.5	Vdc
	Vin_ON	44.5	46.0	47.5	Vdc
96Vin : Ruvlo = 2.49kΩ	Vin_OFF	61.3	62.8	64.3	Vdc
	Vin_ON	63.3	64.8	66.3	Vdc
110Vin : Ruvlo = 2.37kΩ	Vin_OFF	63.5	65.0	66.5	Vdc
	Vin_ON	65.5	67.0	68.5	Vdc

### FUNCTIONAL SPECIFICATIONS: IRQ-54/2.8-W80

EFFICIENCY						
100% Load	Vin=24V; Details see Figures		85		%	
100% Load	Vin=110V; Details see Figures		89		%	
DYNAMIC CHARACTERISTICS						
Output Voltage During Load Current Transient						
Step Change in Output Current (0.1A/uS)	Iout 50-75-50% nom, within 1% of Vout		150		uS	
Peak deviation	Full Load, 1µF ceramic, 10µF tantalum		±200	±400	mV	
Turn-On Transient						
Start-up Time, From ON/OFF Control	See Figures		50	460	mS	
Start-up Time, From Input	See Figures		150	460	mS	
Rise Time	Time from 10% to 90% of nominal output voltage			100	mS	
Output Voltage Overshoot				2	%	
ISOLATION CHARACTERISTICS		NOTES AND CONDITIONS	MIN.	TYP.	MAX.	UNITS
Insulation Safety Rating						
Input to Output				Reinforced		
Input to Baseplate				4242		Vdc
Output to Baseplate				2250		Vdc
Isolation Resistance	Input/Output			20		MΩ
Isolation Capacitance	Input/Output			750		pF
TEMPERATURE LIMITS FOR POWER DERATING CURVES						
Semiconductor Junction Temperature					Tjmax-25	°C
Board Temperature	UL rated max operating temp 130°C				130	°C
Transformer/Inductor Temperature					130	°C
FEATURE CHARACTERISTICS						
Switching Frequency		230	255	280		kHz
ON/OFF Control (Blank suffix)						
Off-State Voltage		0		0.7		V
On-State Voltage	Open the ON/OFF pin = ON	2		15		V
ON/OFF Control (N suffix)						
Off-State Voltage	Open the ON/OFF pin = OFF	2		15		V
On-State Voltage		0		0.7		V
ON/OFF Control Current (Either Option)						
Current thru ON/OFF pin	Von/off=0V		1	2		mA
Current thru ON/OFF pin	Von/off=15V			1		mA
Remote Sense Compensation						
Output Voltage Trim Range	Pout<=Max rated power	-20	4	10		%
Trim Up Equations	Please see TRIM functions in Technical Notes					
Trim Down Equations	Please see TRIM functions in Technical Notes					
Output Over-Voltage Protection	Hiccup mode; over full temp range; % of nominal Vout	59.4	65	70.2		Vdc
Over-Temperature Shutdown						
With Baseplate			125			°C
Restart Hysteresis			6			°C
RELIABILITY/SAFETY/ENVIRONMENTAL						
Safety	Certified to UL 60950-1, CAN/CSA C22.2 60950-1, 2nd edition		Yes			
Calculated MTBF	Per Telcordia SR332, Issue 2, Method 1, Class 1		1.48			MHrs
Conducted Emissions	External filter is required, see Technical Notes		EN55011 CLASS A			
MECHANICAL						
Outline Dimensions			2.41 x 1.56 x 0.512		Inches	
(Please refer to outline drawing)	L x W x H		61.21 x 39.62 x 13		mm	
Weight			3		Ounces	
			90		Grams	
Through Hole Pin Diameter			0.04 & 0.06		Inches	

**TYPICAL PERFORMANCE DATA: IRQ-54/2.8-W80**

**IRQ-54/2.8-W80 Efficiency vs Pout**

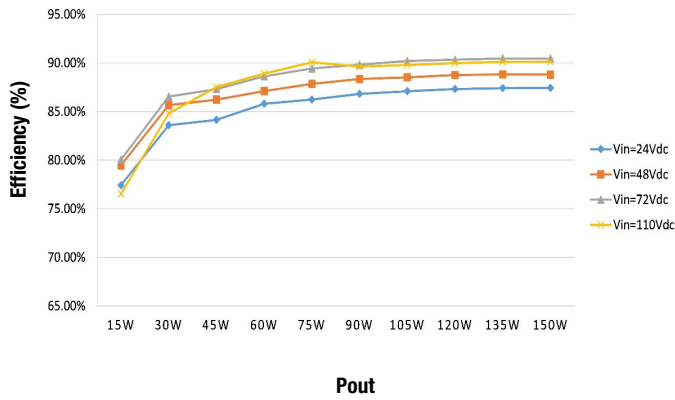

**IRQ-54/2.8-W80 Power Dissipation vs Load**

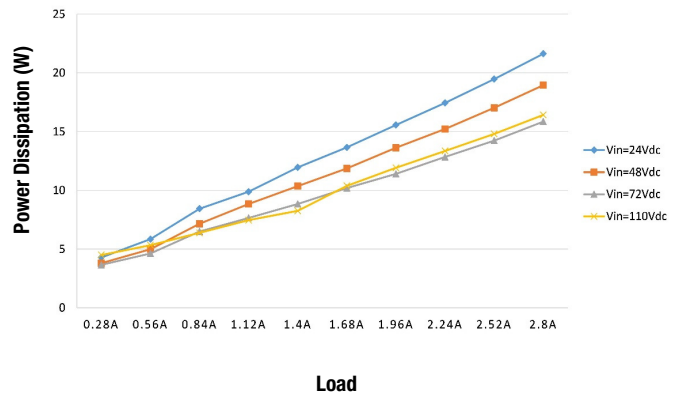

**IRQ-54/2.8-W80 Temperature Derating**

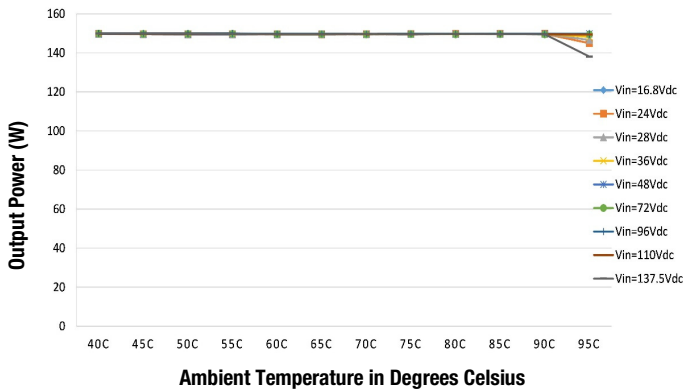

**Turn On Transient VS Enable @ 72V with Full load with 470uF load caps**

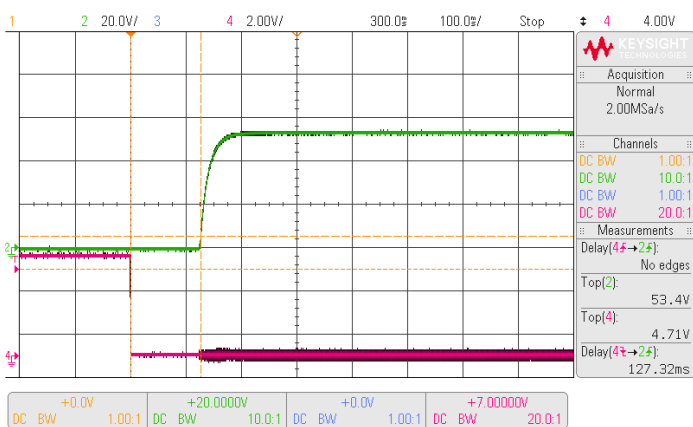

**Turn On Transient VS Vin @ 72V with Full load with 470uF load caps**

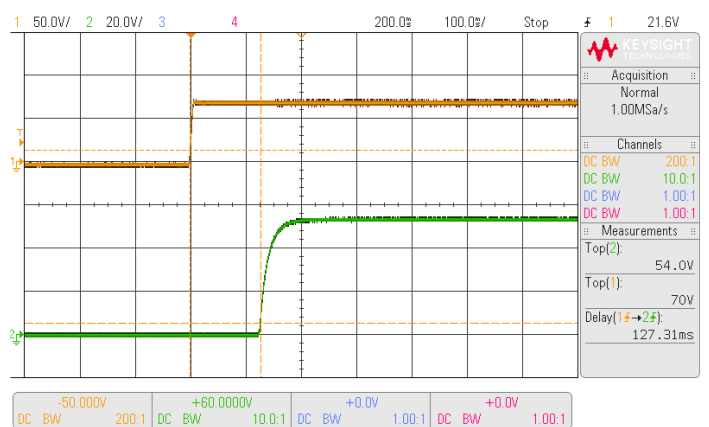

**TYPICAL PERFORMANCE DATA: IRQ-54/2.8-W80**

**Output voltage response to step-change in load current**  
(50%-75%-50% of full load; di/dt = 0.1A/ $\mu$ s)

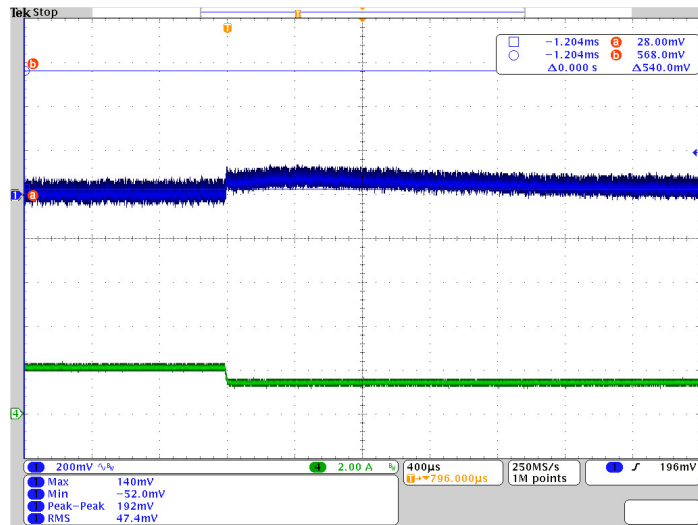

**Output voltage response to step-change in load current**  
(50%-75%-50% of full load; di/dt = 0.1A/ $\mu$ s)

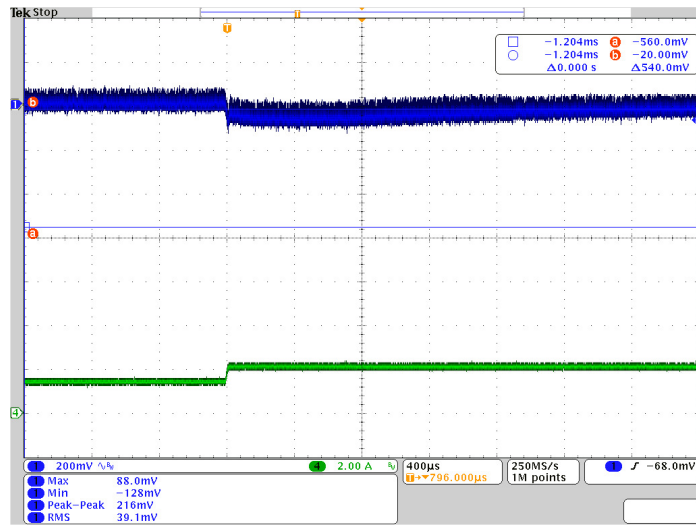

**Output voltage response to step-change in load current**  
(50%-75%-50% of full load; di/dt = 0.1A/ $\mu$ s)

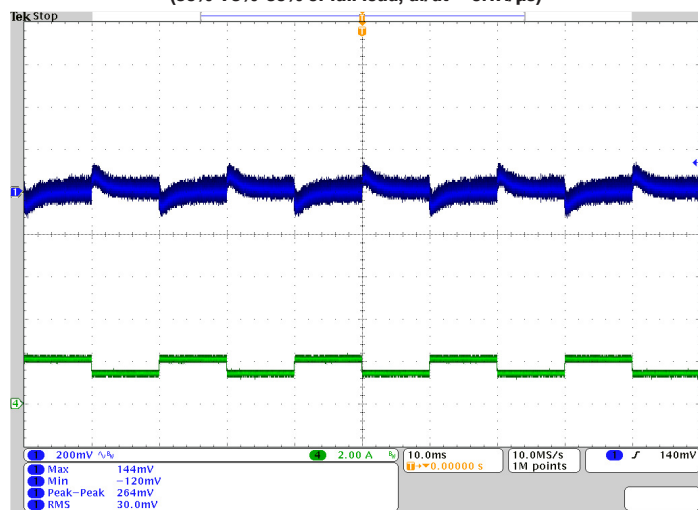

**Output Ripple@20MHz BW,**  
**Vin = 72Vdc, Full Load with 470uF output capacitance**

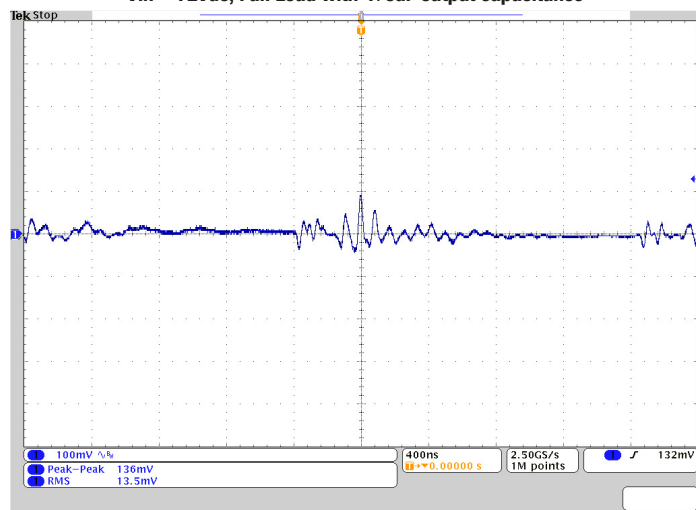

## MECHANICAL SPECIFICATIONS

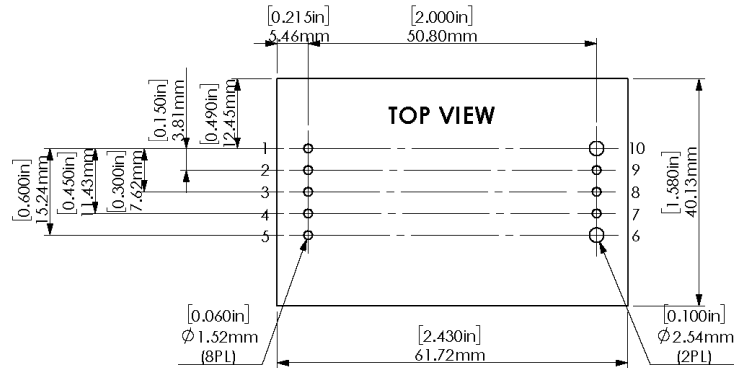
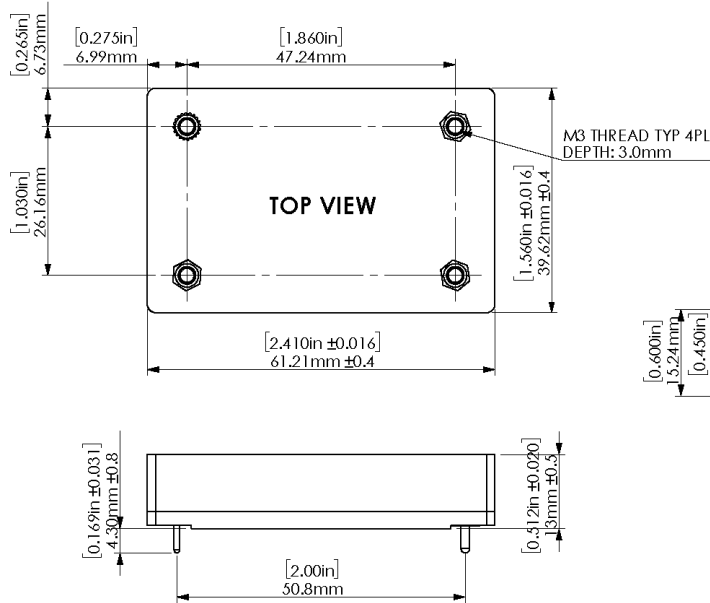

**RECOMMENDED FOOTPRINT**

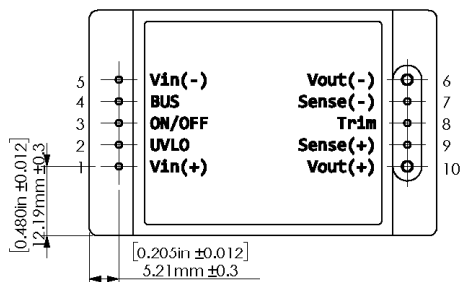

### INPUT/OUTPUT CONNECTIONS

Pin	Designation	Function
1	Vin (+)	Positive Input
2	UVLO	Under Voltage Lockout
3	ON/OFF	ENABLE
4	BUS	BUS Voltage
5	Vin (-)	Negative Input
6	Vout (-)	Negative Output
7	Sense (-)	Sense (-)
8	Trim	Trim
9	Sense (+)	Sense (+)
10	Vout (+)	Positive Output

- NOTES:  
UNLESS OTHERWISE SPECIFIED:  
1: ALL DIMENSIONS ARE IN INCHES (MILLIMETER).  
2: ALL TOLERANCES:  
x.xx in, ±0.02 in (x.x mm, ±0.5 mm),  
x.xxx in, ±0.01 in (x.xxx mm, ±0.25 mm).  
3: APPLIED TORQUE PER SCREW SHOULD NOT EXCEED 5.3 in-lb (0.6 Nm).  
4: PIN 1-5, 7-9: DIA 0.040 in PINS: COPPER ALLOY,  
PIN 6, 10: DIA 0.060 in PINS: COPPER ALLOY,  
FINISH: GOLD (5µ" MIN) OVER NICKEL (100µ" MIN).



### SHIPPING BOX AND TRAY DIMENSIONS

ITEM NO. (7770546)	PART NUMBER	DESCRIPTION	QTY
1	2300208	SHIPPING BOX, 10" X 10" X 2.50"	3
2	2300221	SHIPPING TRAY BASE (PAD), .75" THICK	3 (NOTE 8)
3	2300234	SHIPPING TRAY, 1/4 BRICK (15 CAVITY)	6
4	2300159	LABEL, 1.0" X 1.5" PAPER	3
5	5600-01098-0	LABEL, PRE-PRINTED ESD ATTENTION	3
6	5652-01166-0	LABEL, PAPER, 2.0" X 4.0"	3 (NOTE 6)
7	6200-01211-0	ESD TAPE, 3/4" WIDE	10
8	6256-01125-0	ESD PAD 335mm X 305mm	2
9	6256-01124-0	ESD PAD 335mm X 225mm	2
10	6256-01126-0	ESD PAD 255mm X 225mm	2
11	6256-01127-0	RIGHT ANGLE CLIP	4
12	6256-01128-0	OUTER PACKAGE CARTON	1

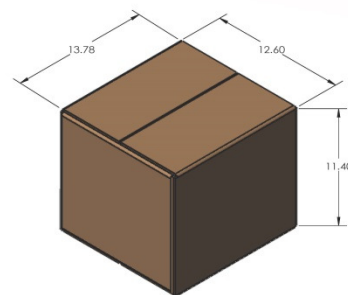
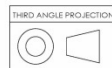

ITEM NUMBERS REFER TO 7770546 BOM. ITEMS ABOVE ARE FOR REFERENCE ONLY, REFER TO APPROPRIATE BOM FOR COMPLETE LIST OF PARTS

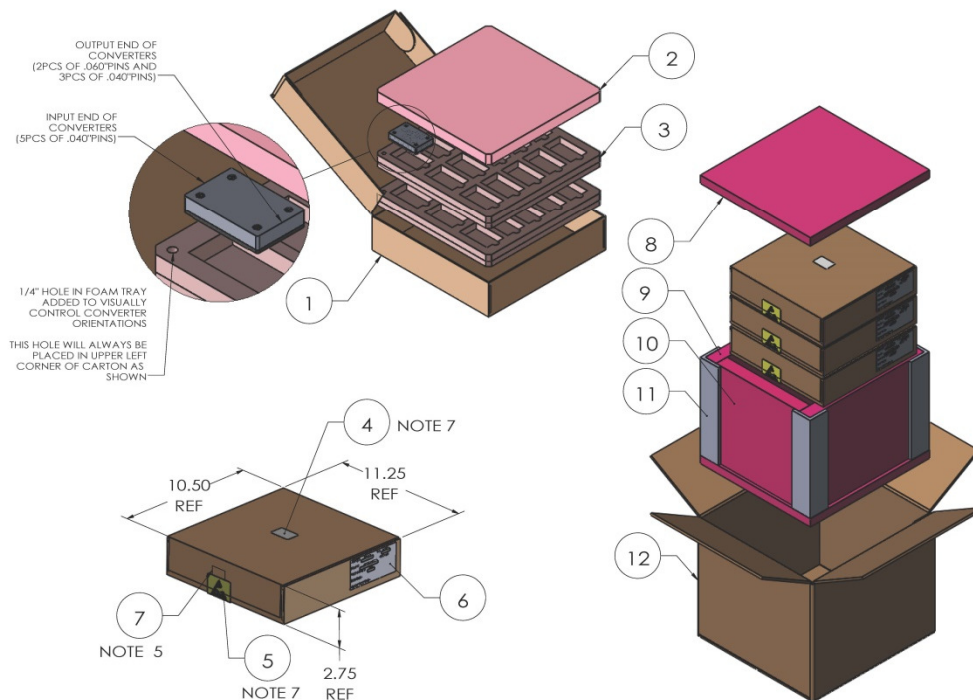

**NOTES:**

1. THIS DOCUMENT DEFINES THE GENERAL PACKING RULES FOR APPLICABLE SHIPPING KIT. INFORMATION FOR SEALING AND MARKING IS NOT PART OF THIS DOCUMENT.
2. REFER TO SHIPPING KIT BOM DETAILS.
3. INSERT UNITS INTO FOAM POCKETS IN TRAYS APPROX AS SHOWN
4. EACH FOAM TRAY (ITEM 3) CONTAINS 15 UNITS. EACH BOX (ITEM 1) CONTAINS 30 UNITS. IN FULL CARTON ITEM 12 QUANTITIES, 3 BOXES (ITEM 1) EQUAL A TOTAL OF 90 UNITS.
5. IF SHIPPING QTY IS 30PCS, PLEASE ALSO USE ITEM 12 TO MAKE THE PACKAGE TWO EMPTY BOX ITEM 1 PUT ON THE BOX ITEM 1 WITH PRODUCTS.
6. FRONT FLAP SHALL BE SEALED WITH ESD TAPE SPECIFIED OR EQUIVALENT AFTER THE BOX IS CLOSED.
7. LABEL (ITEM 6) USED FOR MFR OVERPACK CARTON
8. APPLY ESD LABEL (ITEM 5) OVER TAPE USED TO SEAL BOX AND APPLY IDENTIFICATION LABEL (ITEM 4) APPROX AS SHOWN.
9. PAD (ITEM 2) MAY, AT MFR'S OPTION, BE EXCHANGED FOR THINNER PAD IF FOAM STACKUP EXCEEDS CARTON HEIGHT BY >1/8" OR ADDITIONAL PAD MAY BE ADDED IF STACKUP IS BELOW INSIDE CARTON HEIGHT BY >1/8". ALTERNATE PADS: 1/4" THK=2300216, 3/8" THK=2300218, 1/2" THK=2300219, 3/4" THK=2300221

**NOTES:**

1. MATERIAL: DOW ETHAFOAM SELECT ANTI-STATIC, COLOR PINK, LOW DENSITY CLOSED CELL POLYETHYLENE FOAM
2. ALL DIMENSIONS IN INCHES
3. ASSEMBLY CONSISTS OF DIE-CUT FRAME WITH SOLID BASE, GLUED TOGETHER. GLUE NOT PERMITTED WITHIN CUTOUT POCKETS.

**MPQ = 30**

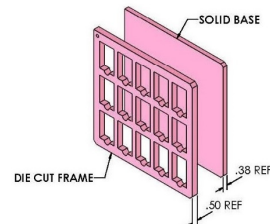
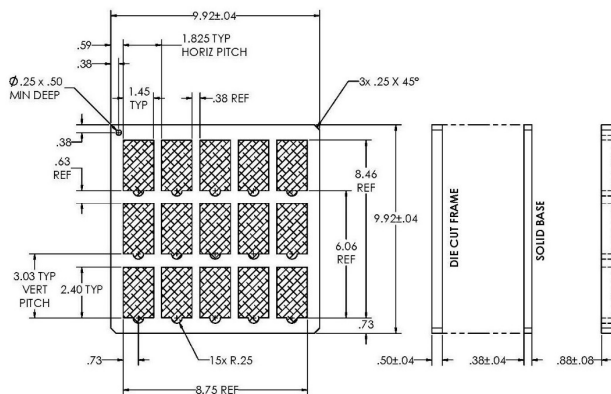

### TECHNICAL NOTES

#### On/Off Control

The input-side, remote On/Off Control function (pin 3) can be ordered to operate with either logic type:

Negative (“N” suffix): Negative-logic devices are off when pin 3 is left open (or pulled high, applying +2V to +15V), and on when pin 3 is pulled low (0 to 0.7V) with respect to –Input as shown in Figure 1.

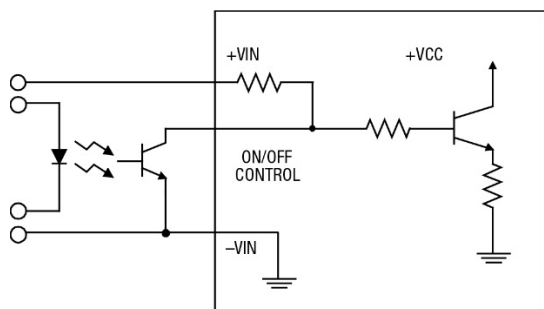

**Figure 1. Driving the Negative Logic On/Off Control Pin**

Dynamic control of the remote on/off function is best accomplished with a mechanical relay or an open-collector/open-drain drive circuit (optically isolated if appropriate). The drive circuit should be able to sink appropriate current (see Performance Specifications) when activated and withstand appropriate voltage when deactivated. Applying an external voltage to pin 3 when no input power is applied to the converter can cause permanent damage to the converter.

#### Input Fusing

Certain applications and/or safety agencies may require fuses at the inputs of power conversion components. Fuses should also be used when there is the possibility of sustained input voltage reversal which is not current-limited. For greatest safety, we recommend a fast blow fuse installed in the ungrounded input supply line.

Vin	Fuse Rate Current
24V	15A fast
48V	8A fast
72V	5A fast
110V	3A fast

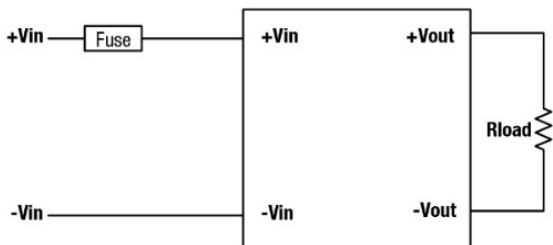

**Figure 2. Input Fusing**

#### Input Under-Voltage Shutdown and Start-Up Threshold

Under normal start-up conditions, converters will not begin to regulate properly until the rising input voltage exceeds and remains at the Start-Up Threshold Voltage (see Specifications). Once operating, converters will not turn off until the input voltage drops below the Under-Voltage Shutdown Limit. Subsequent restart will not occur until the input voltage rises again above the Start-Up Threshold. This built-in hysteresis prevents any unstable on/off operation at a single input voltage. Figure 3 shows a typical configuration.

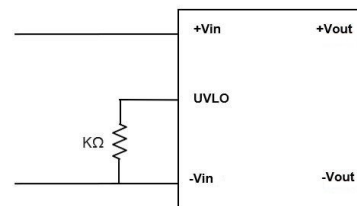

**Figure 3. Under Voltage Lockout Configuration**

The tables below show UVLO values for various nominal input voltages and the required resistor for each.

The following parameters apply to Vo is 12V

Nominal Vin	24V	36V	48V	72V	96V	110V
Turn-off Threshold	12±1V	20.5±1V	29±1V	43±1.5V	60.5±2V	64.3±2V
Turn-on threshold	15±1V	23.5±1V	32±1V	46±1.5V	63.8±2V	67.3±2V
UVLO External Resistor	open	20.5kΩ	10.7kΩ	5.9kΩ	3.74kΩ	3.48kΩ

The following parameters apply to Vo is 24V or 54V

Nominal Vin	24V	36V	48V	72V	96V	110V
Turn-off Threshold	12±1V	22±1V	30±1V	44±1.5V	62.8±1.5V	65±1.5V
Turn-on threshold	14±1V	24±1V	32±1V	46±1.5V	64.8±1.5V	67±1.5V
UVLO External Resistor	open	12.7kΩ	6.98kΩ	3.92kΩ	2.49kΩ	2.37kΩ

## 150W 10:1 Ultra Wide Input Encapsulated Quarter-Brick Isolated DC-DC Converter

### Hold-Up Time and BUS Capacitor

The BUS pin is for hold-up time function. It is designed to work with an external circuit comprising a cap (Chold), a resistor and a diode. (Hold up time is defined as the duration of time that the DC/DC converter output will remain active following a loss of input power). When this function is activated, the module will use the energy stored in external circuit to support operation. Please note that the BUS pin is a voltage source output of 80Vdc to allow external capacitors to be connected in order to provide hold up power of the converter. After 80Vdc input, it tracks the DC input voltage range up to 160Vdc. A typical configuration is shown in Figure 4 below.

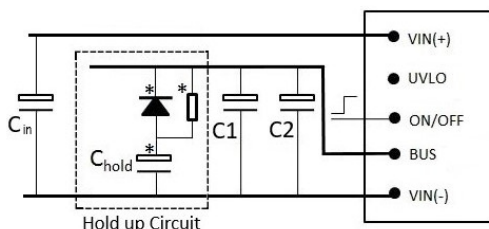

**Figure 4. Connection of External Hold-up Circuit**

NOTE: Two low ESR electrolytic BUS capacitors connected between BUS and Vin- are necessary for stability (C1 and C2 are 120µF/250V caps). A 220µF input capacitor (Cin) is also recommended between Vin+ and Vin-.

This function provides energy that maintains the DC/DC converter in operation for 10ms/20ms/30ms of hold-up time. The capacitance (Chold) in the application is recommended in the hold-up table below.

Hold up Time	24V	36V	48V	72V	96V	110V
10ms	1800uF	1800uF	1800uF	1800uF	550uF	330uF
20ms	3600uF	3600uF	3600uF	3600uF	1100uF	660uF
30ms	5400uF	5400uF	5400uF	5400uF	1650uF	990uF

NOTE: The resistor value recommended is 100ohm.

### Start-Up Time

Assuming that the output current is set at the rated maximum, the Vin to Vout Start-Up Time (see Specifications) is the time interval between the point when the rising input voltage crosses the Start-Up Threshold and the fully loaded output voltage enters and remains within its specified accuracy band. Actual measured times will vary with input source impedance, external input capacitance, input voltage slew rate and final value of the input voltage as it appears at the converter.

These converters include a soft start circuit to moderate the duty cycle of its PWM controller at power up, thereby limiting the input inrush current.

The On/Off Remote Control interval from On command to Vout (final ±2%) assumes that the converter already has its input voltage stabilized above the Start-Up Threshold before the On command. The

interval is measured from the On command until the output enters and remains within its specified accuracy band. The specification assumes that the output is fully loaded at maximum rated current. Similar conditions apply to the On to Vout regulated specification such as external load capacitance and soft start circuitry.

### Recommended Input Filtering

The user must assure that the input source has low AC impedance to provide dynamic stability and that the input supply has little or no inductive content, including long distributed wiring to a remote power supply. The converter will operate with no additional external capacitance if these conditions are met.

For best performance, we recommend installing a low-ESR capacitor immediately adjacent to the converter’s input terminals. The capacitor should be a ceramic type such as the Murata GRM32 series or a polymer type. Make sure that the input terminals do not go below the undervoltage shutdown voltage at all times. More input bulk capacitance may be added in parallel (either electrolytic or tantalum) if needed.

### Recommended Output Filtering

The converter will achieve its rated output ripple and noise with no additional external capacitor. However, the user may install more external output capacitance to reduce the ripple even further or for improved dynamic response. Again, use low-ESR ceramic (Murata GRM32 series) or polymer capacitors. Mount these close to the converter. Measure the output ripple under your load conditions.

Use only as much capacitance as required to achieve your ripple and noise objectives. Excessive capacitance can make step load recovery sluggish or possibly introduce instability. Do not exceed the maximum rated output capacitance listed in the specifications.

### Input Ripple Current and Output Noise

All models in this converter series are tested and specified for input reflected ripple current and output noise using designated external input/output components, circuits and layout as shown in the figures below. The Cbus and Lbus components simulate a typical DC voltage bus.

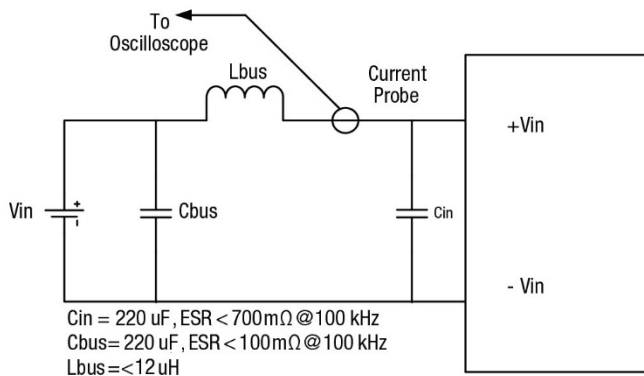

**Figure 5. Measuring Input Ripple Current**

## 150W 10:1 Ultra Wide Input Encapsulated Quarter-Brick Isolated DC-DC Converter

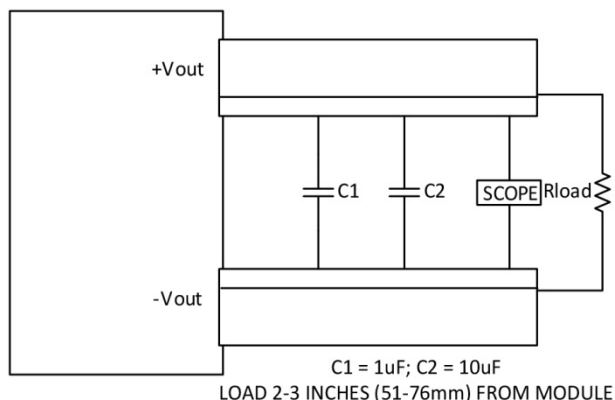

**Figure 6. Measuring Output Ripple and Noise (PARD)**

PWM controller will shut down. Following a time-out period, the PWM will restart, causing the output voltage to begin rising to its appropriate value. If the short-circuit condition persists, another shutdown cycle will initiate. This rapid on/off cycling is called “hiccup mode.” The hiccup cycling reduces the average output current, thereby preventing excessive internal temperatures and/or component damage.

The “hiccup” system differs from older latching short circuit systems because you do not have to power down the converter to make it restart. The system will automatically restore operation as soon as the short circuit condition is removed.

### Output Capacitive Load

These converters do not require external capacitance added to achieve rated specifications. Users should only consider adding capacitance to reduce switching noise and/or to handle spike current load steps. Install only enough capacitance to achieve noise objectives. Excess external capacitance may cause degraded transient response and possible oscillation or instability.

### Remote Sense Input

Use the Sense inputs with caution. Sense is normally connected at the load. Sense inputs compensate for output voltage inaccuracy delivered at the load. This is done by correcting IR voltage drops along the output wiring and the current carrying capacity of PC board etc. This output drop (the difference between Sense and Vout when measured at the converter) should not exceed 0.5V. Consider using heavier wire if this drop is excessive. Sense inputs also improve the stability of the converter and load system by optimizing the control loop phase margin.

**NOTE:** The Sense input and power Vout lines are internally connected through low value resistors to their respective polarities so that the converter can operate without external connection to the Sense. Nevertheless, if the Sense function is not used for remote regulation, the user should connect +Sense to +Vout and – Sense to –Vout at the converter pins.

The remote Sense lines carry very little current. They are also capacitively coupled to the output lines and therefore are in the feedback control loop to regulate and stabilize the output. As such, they are not low impedance inputs and must be treated with care in PC board layouts. Sense lines on the PCB should run adjacent to DC signals, preferably Ground. In cables and discrete wiring, use twisted pair, shielded tubing or similar techniques.

Any long, distributed wiring and/or significant inductance introduced into the Sense control loop can adversely affect overall system stability. If in doubt, test your applications by observing the converter’s output transient response during step loads. There should not be any appreciable ringing or oscillation. You may also adjust the output trim slightly to compensate for voltage loss in any external filter elements. Do not exceed maximum power ratings.

### Output Over-Voltage Protection

The IRQ-W80 output voltage is monitored for an over-voltage condition using a comparator. The signal is optically coupled to the primary side and if the output voltage rises to a level which could be damaging to the load, the sensing circuitry will disable the PWM controller drive causing the output voltage to decrease. It is referred to as “latch” mode.

### Minimum Output Loading Requirements

All models regulate within specification and are stable under no load to full load conditions. Operation under no load might however slightly increase output ripple and noise.

### Over-Temperature Protection

The over-temperature protection consists of circuitry that provides protection from thermal damage. If the over-temperature is detected the module will shut down, and restart after the temperature is within specification.

### Output Fusing

The converter is extensively protected against current, voltage and temperature extremes. However, your output application circuit may need additional protection. In the extremely unlikely event of output circuit failure, excessive voltage could be applied to your circuit. Consider using an appropriate fuse in series with the output.

### Output Current Limiting

The modules include an internal output over-current protection circuit, which endure current limiting for an unlimited duration during output overload. If the output current exceeds the OCP set point, the module will shut down, and always try to restart (hiccup mode) until the over current condition is corrected.

### Output Short Circuit Condition

When a converter is in current-limit mode, the output voltage will drop as the output current demand increases. If the output voltage drops too low (approximately 97% of nominal output voltage for most models), the



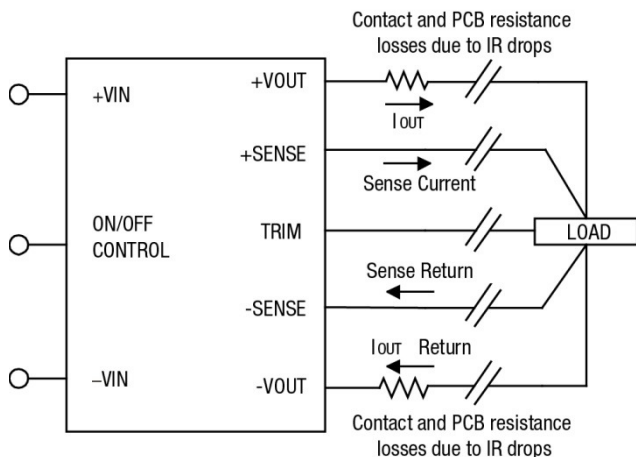

**Figure 7. Remote Sense Circuit Configuration**

**NOTE:** Please observe Sense inputs tolerance to avoid improper operation: The value of the Output Sense Range depends on the Output voltage, which decreases as the increases of the output voltage.

Output overvoltage protection is monitored at the output voltage pin, not the Sense pin. Therefore, excessive voltage differences between Vout and Sense together with trim adjustment of the output can cause the overvoltage protection circuit to activate and shut down the output.

Power derating of the converter is based on the combination of maximum output current and the highest output voltage. Therefore, the designer must ensure: (Vout at pins) x (Iout) ≤ (Max. rated output power)

$$[V_{out(+)} - V_{out(-)}] - [Sense(+) - Sense(-)] \leq \text{Output Sense Range}$$

V <sub>o</sub>	12V	24V	54V
Output Sense Range	10%	5%	4%

### Through-Hole Soldering Guidelines

Murata Power Solutions recommends the TH soldering specifications below when installing these converters. These specifications vary depending on the solder type. Exceeding these specifications may cause damage to the product. Your production environment may differ; therefore, please thoroughly review these guidelines with your process engineers.

#### Wave Solder Operations for Through-Hole Mounted Products

<b>For Sn/Ag/Cu based solders:</b>	
Maximum Preheat Temperature	115° C.
Maximum Pot Temperature	270° C.
Maximum Solder Dwell Time	7 seconds
<b>For Sn/Pb based solders:</b>	
Maximum Preheat Temperature	105° C.
Maximum Pot Temperature	250° C.
Maximum Solder Dwell Time	6 seconds

### Trimming the Output Voltage

The Trim input to the converter allows the user to adjust the output voltage over the rated trim range (please refer to the Specifications). In the trim equations and circuit diagrams that follow, trim adjustments use either a trimpot or a single fixed resistor connected between the Trim input and either the +Sense or -Sense terminals. Trimming resistors should have a low temperature coefficient (±100 ppm/deg.C or less) and be mounted close to the converter. Keep leads short. If the trim function is not used, leave the trim unconnected. With no trim, the converter will exhibit its specified output voltage accuracy.

There are two CAUTIONs to observe for the Trim input:

**CAUTION:** To avoid unplanned power down cycles, do not exceed EITHER the maximum output voltage OR the maximum output power when setting the trim. Be particularly careful with a trimpot. If the output voltage is excessive, the OVP circuit may inadvertently shut down the converter. If the maximum power is exceeded, the converter may enter current limiting. If the power is exceeded for an extended period, the converter may overheat and encounter overtemperature shut down.

**CAUTION:** Be careful of external electrical noise. The Trim input is a sensitive input to the converter's feedback control loop. Excessive electrical noise may cause instability or oscillation. Keep external connections short to the Trim input. Use shielding if needed.

### Trim Equations

**Trim Down:** Connect trim resistor between trim pin and -Sense

When V<sub>nom</sub> = 12V

$$R_{Trimdn} (k\Omega) = 1 * \frac{V_{nom}}{V_{nom} - V_o} - 2$$

When V<sub>nom</sub> = 24V or 54V

$$R_{Trimdn} (k\Omega) = 10 * \frac{V_{nom}}{V_{nom} - V_o} - 20$$

**Trim Up:** Connect trim resistor between trim pin and +Sense

When V<sub>nom</sub> = 12V

$$R_{Trimup} (k\Omega) = \frac{1 * V_{nom} * (1 + \frac{V_o - V_{nom}}{V_{nom}})}{1.225 * \frac{V_o - V_{nom}}{V_{nom}}} - 1 * \frac{V_{nom}}{V_o - V_{nom}} - 2$$

When V<sub>nom</sub> = 24V or 54V

$$R_{Trimup} (k\Omega) = \frac{10 * V_{nom} * (1 + \frac{V_o - V_{nom}}{V_{nom}})}{1.225 * \frac{V_o - V_{nom}}{V_{nom}}} - 10 * \frac{V_{nom}}{V_o - V_{nom}} - 20$$

**When Vnom = 12V**

Output Voltage	10.8V	11.4V	12.6V	13.2V
Rtrim up (kΩ)	NA	NA	183.71	95.76
Rtrim down (kΩ)	8	18	NA	NA

**When Vnom = 24V**

Output Voltage	21.6V	22.8V	25.2V	26.4V
Rtrim up (kΩ)	NA	NA	3894.26	2035.10
Rtrim down (kΩ)	80	180	NA	NA

**When Vnom = 54V**

Output Voltage	48.6V	51.3V	56.7V	59.4V
Rtrim up (kΩ)	NA	NA	9037.14	4728.98
Rtrim down (kΩ)	80	180	NA	NA

**NOTE:** Do not exceed the specified trim range or maximum power ratings when adjusting trim. Use 1% precision resistors mounted close to the converter on short leads. If sense is not installed, connect the trim resistor to the respective Vout pin.

**Trim Circuits**

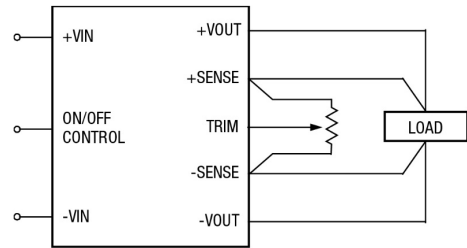

**Figure 8. Trim Connections Using a Trimpot**

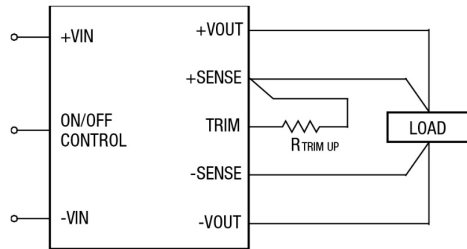

**Figure 9. Trim Connections to Increase Output Voltage**

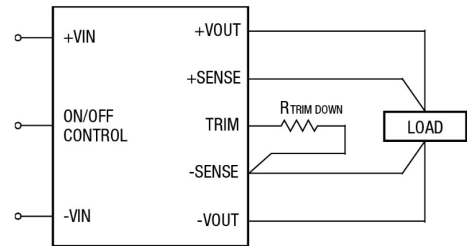

**Figure 10. Trim Connections to Decrease Output Voltage**

### Qualification Tests

Parameters	Test Conditions	Operating
Vibration	EN 61373:2010 Clause 8, Bogie mounted	Yes
Mechanical Shock	EN 61373:2010 Clause 10, Bogie mounted	Yes
DMTBF (Life Test)	Vin nom, units at derating point, 35 days	Yes
Temperature Cycling Test (TCT)	-40°C to 125°C, unit temp. ramp 15°C/min., 500 cycles	Yes
Temperature, Humidity and Bias (THB)	85°C, 85RH, Vin=max, Load=min load, 1072 Hour (72 hours with a pre-conditioning soak, unpowered)	No
Damp heat test, cyclic	EN60068-2-30: Temperature +55°C and +25°C; Number of cycles 2 (respiration effect); Time 2 x 24 hours; Relative Humidity 95%	No
Dry heat test	EN60068-2-2, Vin=nom, Full load, 85°C for 6 hours.	Yes
Low Temperature operating	Vin=nom, Full load, -40°C for 2 hours.	Yes
Highly Accelerated Life Test (HALT)	High temperature limits, low temperature limits, Vibration limits, Combined Environmental Tests.	Yes
EMI	CISPR 22 Class A, or IEC62236-3-2 (GB/T 24338.4)	Yes
ESD	IEC6100-4-2: ±6kV contact discharge / ±8kV air discharge	Yes
Surge Protection	IEC/EN 61000-4-5	Yes
Solderability	IPC/EIAJ-STD-002B (Solderability Tests for Component Leads, Terminations, Lugs, Terminals and Wires)	No

### Conducted Emissions Test Results (IRQ-24Vout)

Vin = 48V, Line L

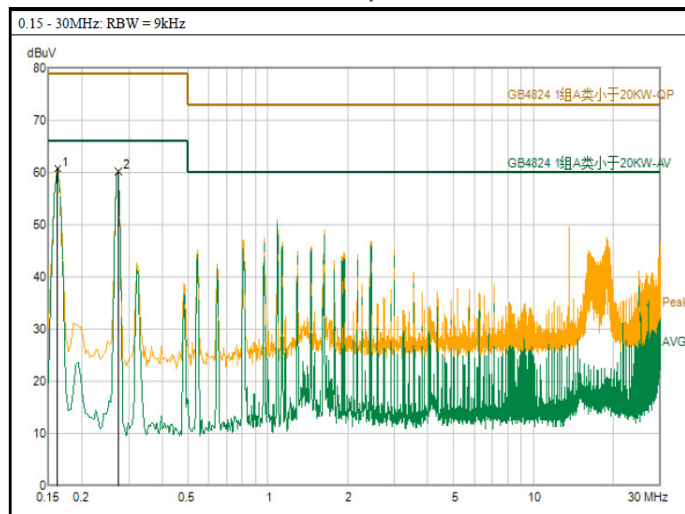

序号	频率 (MHz)	读值 (dBuV)	修正因子 (dB)	结果 (dBuV)	限值 (dBuV)	余量 (dB)	备注
1	0.162	36.67	24.07	60.74	66	5.26	平均值
2	0.274	36.22	24.01	60.23	66	5.77	平均值

注: 结果 = 读值 + 修正因子, 余量 = 限值 - 结果



## EMI Filter, Schematic & Parts List

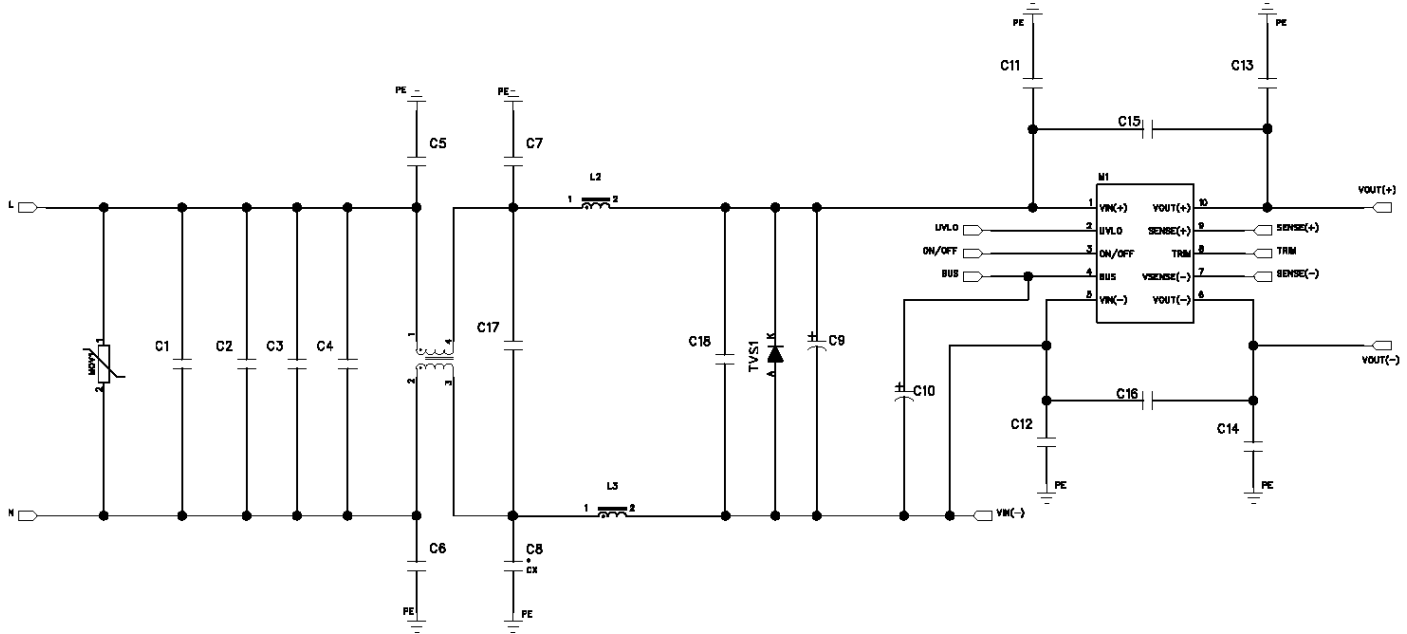

Part	Manufacturer	MPN	Description
MOV	Epcos	B72214S0141K101	Varistor, 180V
C1	Faratronic	C212E475K9AC000	4.7uF, 250V
C2, C3, C4	Murata	GRM43DR72E474KW01L	0.47uF, 250V
C5, C6	Murata	DE1E3RA102MA4BQ01F	1000pF, 300VAC
C11, C12	Murata	DE2E3KY222MA3BM02F	2200pF
C13, C14	Murata	DE1E3KX102MB4BP01F	1000pF
C15, C16	Murata	DE1E3RA472MA4BQ01F	4700pF, 250V
L1	Würth	7448262013	2x1.3mH CMC
L2	Bourns	2101-V-RC	10uH
C9, C10	United Chemicon	EKXJ251EXX271ML40S	270uF, 250V low ESR
C7, C8, C17, C18		NA	Not used

Murata Power Solutions, Inc.  
129 Flanders Rd., Westborough, MA 01581 USA  
ISO 9001 and 14001 REGISTERED



This product is subject to the following [operating requirements](#) and the [Life and Safety Critical Application Sales Policy](#):  
Refer to: <http://www.murata-ps.com/requirements/>

Murata Power Solutions, Inc. makes no representation that the use of its products in the circuits described herein, or the use of other technical information contained herein, will not infringe upon existing or future patent rights. The descriptions contained herein do not imply the granting of licenses to make, use, or sell equipment constructed in accordance therewith. Specifications are subject to change without notice.  
© 2021 Murata Power Solutions, Inc.