

コイン形二酸化マンガンリチウム電池
Coin manganese dioxide lithium batteries

CR2032-H06

■ 外観および外形寸法 Appearance and Dimensions

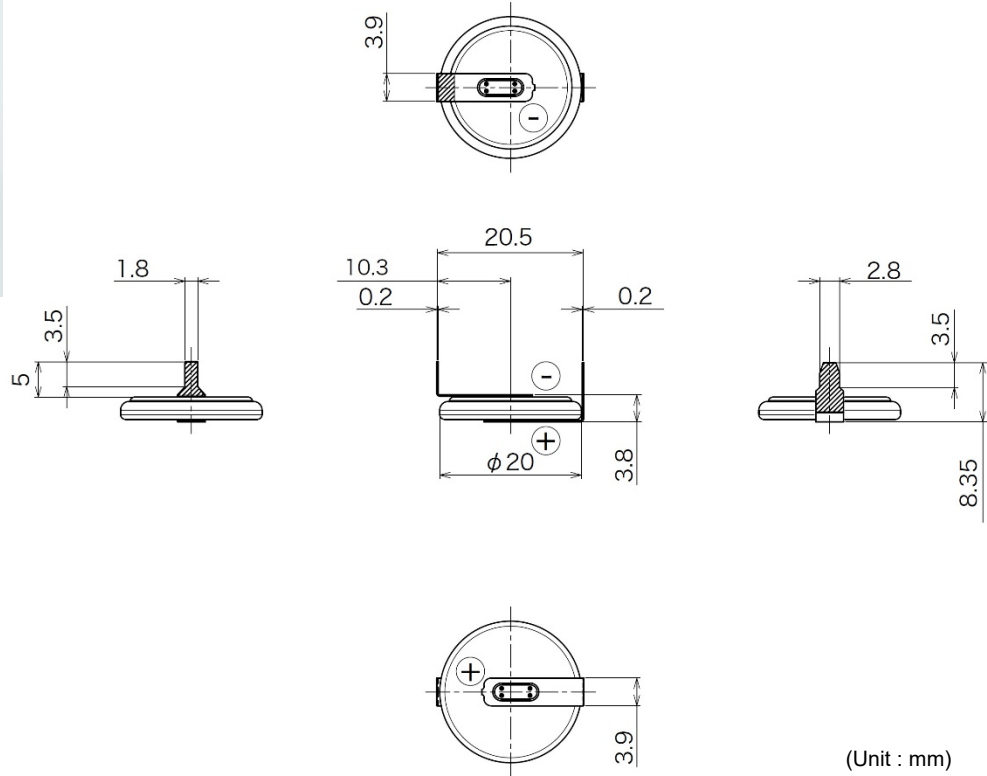

(Unit : mm)

■ 定格 Specifications

公称電圧 Nominal Voltage	3.0 V	+タブ +Tab	ステンレス, めっき (Ni,Sn) Stainless Steel , Partial plating (Ni,Sn)
公称容量 (終止電圧2.0V) Nominal Capacity (2.0V cutoff)	220 mAh	-タブ -Tab	ステンレス, めっき (Ni,Sn) Stainless Steel , Partial plating (Ni,Sn)
標準放電電流値 Standard Discharge Current	0.2 mA	*1 手(はんだ条件 (参考)) *1 Soldering Condition (Recommendation)	はんだごて温度 : 350°C以下 加熱時間 : 5秒以内 Soldering iron temperature: 350°C Max. Heating time: 5sec.Max.
標準質量 Weight	3.3 g	UL認定合格部品 UL Recognized components	
使用温度範囲 Operating Temperature	-30 ~ +70°C	● 許可番号 Certification number : MH12566 ● User replaceable	

*1 注意

- 電池に直接はんだ付けをしないでください。熱によりガスケット等を損傷させ、電池の膨れ、漏液、破裂、発火を引き起こす場合があります。
 - タブ付き電池のはんだ付け条件を守ってください。
- はんだ付けが必要な場合には、タブ付き電池を用いてください。電池への加熱は、ガスケットの熱変形による漏液や電池性能の劣化を引き起こしますので、はんだ付けの際(余熱を含む)、電池温度が使用温度範囲を超えないように注意してください。

*1 Note

- Do not solder batteries directly. Excessive heating may cause deformation of batteries and components such as gaskets, which may lead to swelling, leakage, explosion or ignition of batteries.
 - Observe soldering conditions for tabbed batteries to be specified by manufacturers. Use tabbed batteries if soldering is required. Excessive heating may cause deformation of gaskets, leakages or performance deterioration of batteries.
- Make sure that the battery temperature does not exceed the operating temperature range while soldering (including residual heat).

■ 放電負荷特性

Discharge Characteristics on Load
Test Condition: constant discharge

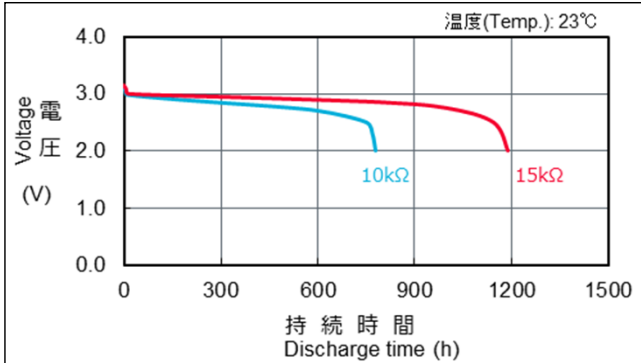

■ 放電温度特性

Discharge Characteristics on Temperature
Test Condition: constant discharge

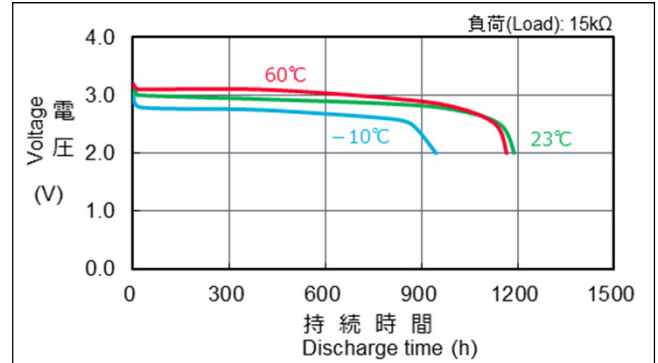

■ 放電負荷と作動電圧 (放電深度40%時の電圧)

Discharge Load vs. Operation Voltage
(Discharge depth 40%)

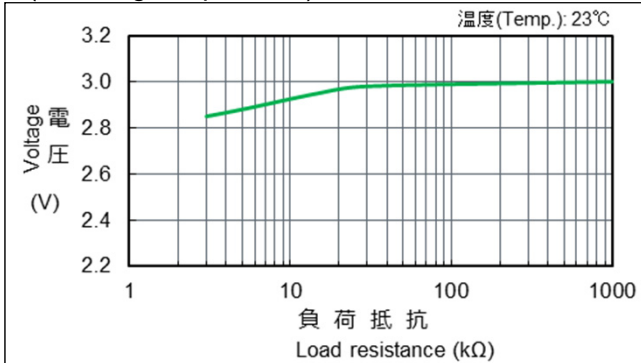

■ 放電負荷と電気容量

Discharge Load vs. Discharge Capacity

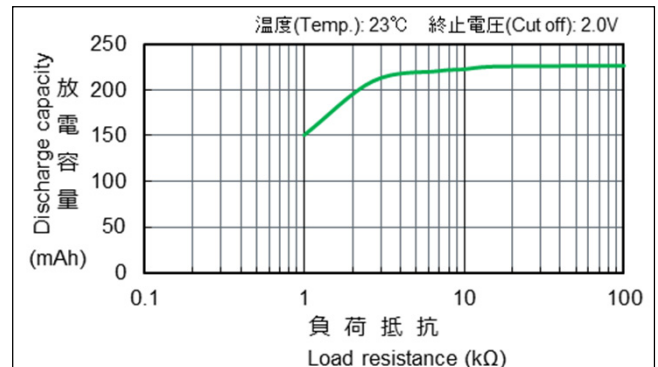

■ パルス放電特性 (放電深度40%時のパルス電圧)

Discharge Characteristics on Pulse Load
(Discharge depth 40%)

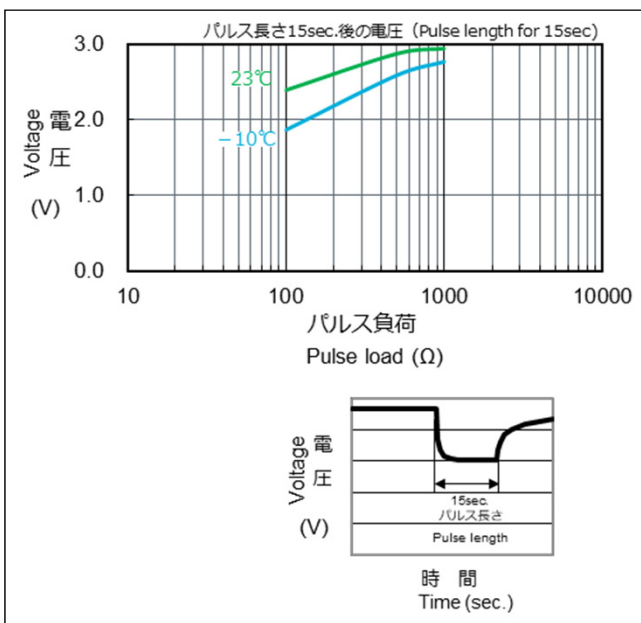

■ 保存特性

Storage Characteristics
Test Condition: constant discharge

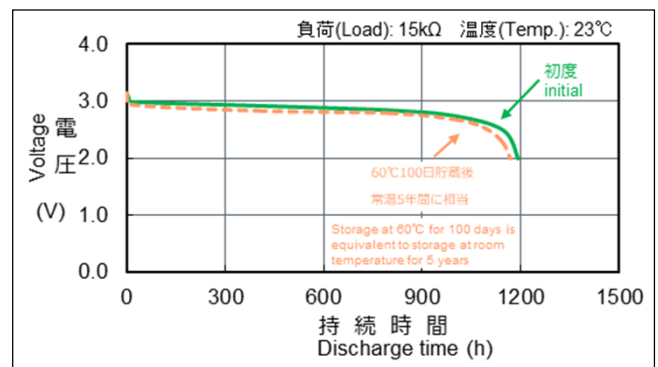

*記載のデータ及び数値は、参考値であり保証値ではありません。

*Data is not guaranteed, and is provided for reference purposes only.