

コイン形二酸化マンガンリチウム電池 **CR2450W-MP1**  
Coin manganese dioxide lithium batteries

■ 外観および外形寸法 Appearance and Dimensions

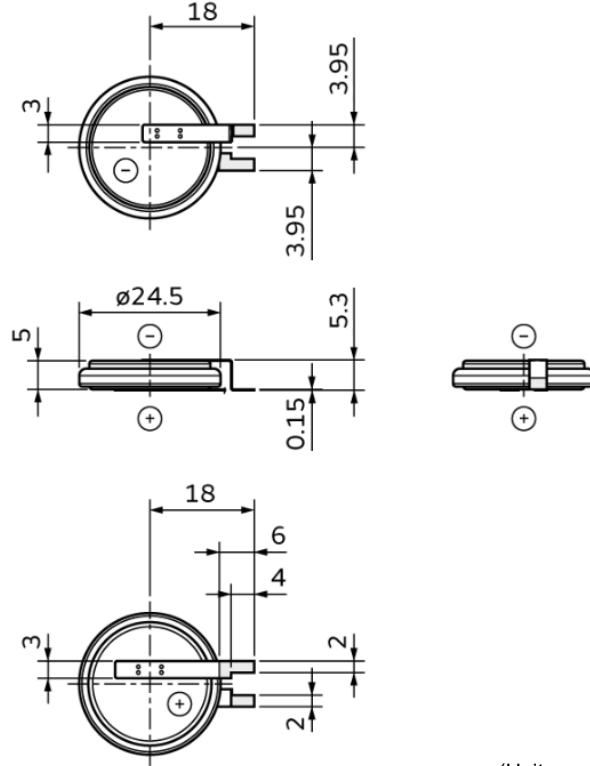

(Unit : mm)

■ 定格 Specifications

公称電圧 <b>Nominal Voltage</b>	3.0 V	+タブ <b>+Tab</b>	ステンレス, めっき (Ni,Sn) Stainless Steel , Partial plating (Ni,Sn)
公称容量 (終止電圧2.0V) <b>Nominal Capacity (2.0V cutoff)</b>	550 mAh	-タブ <b>-Tab</b>	ステンレス, めっき (Ni,Sn) Stainless Steel , Partial plating (Ni,Sn)
推奨連続放電電流値 (容量利用率高) <b>Recommended Continuous Discharge Current (High capacity usage rate)</b>	≤1 mA	*1 手はんだ条件 (参考) <b>*1 Soldering Condition (Recommendation)</b>	はんだごて温度 : 350°C以下 加熱時間 : 5秒以内 Soldering iron temperature: 350°C Max. Heating time: 5sec.Max.
標準質量 <b>Weight</b>	6.8 g	UL認定合格部品 <b>UL Recognized components</b>	
使用温度範囲 <b>Operating Temperature</b>	-40 ~ +125°C	● 許可番号 <b>Certification number</b> : MH12566 ● User replaceable	

\*1 注意

- 電池に直接はんだ付けをしないでください。熱によりガスケット等を損傷させ、電池の膨れ、漏液、破裂、発火を引き起こす場合があります。
- タブ付き電池のはんだ付け条件を守ってください。  
はんだ付けが必要な場合には、タブ付き電池を用いてください。電池への加熱は、ガスケットの熱変形による漏液や電池性能の劣化を引き起こしますので、はんだ付けの際(余熱を含む)、電池温度が使用温度範囲を超えないように注意してください。

\*1 Note

- Do not solder batteries directly. Excessive heating may cause deformation of batteries and components such as gaskets, which may lead to swelling, leakage, explosion or ignition of batteries.
- Observe soldering conditions for tabbed batteries to be specified by manufacturers. Use tabbed batteries if soldering is required. Excessive heating may cause deformation of gaskets, leakages or performance deterioration of batteries.  
Make sure that the battery temperature does not exceed the operating temperature range while soldering (including residual heat).

■ 放電負荷特性

Discharge Characteristics by Load  
Test Condition: constant discharge

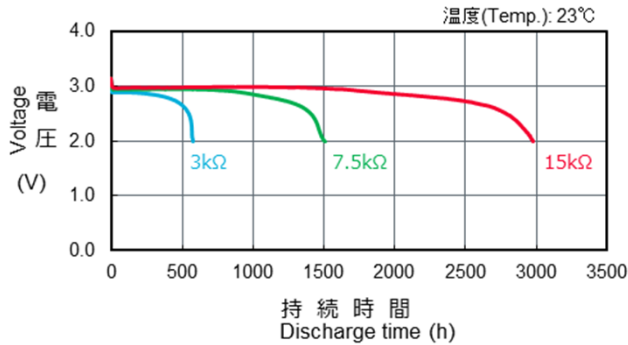

■ 放電温度特性

Discharge Characteristics by Temperature  
Test Condition: constant discharge

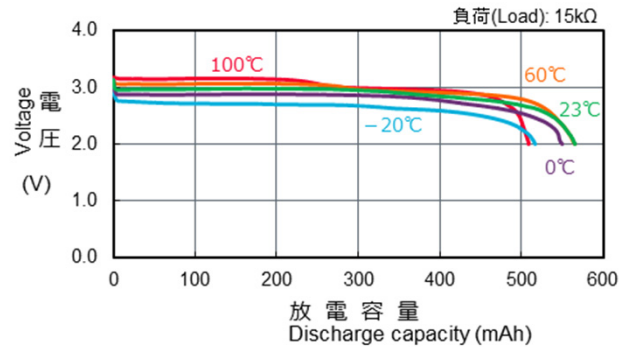

■ 閉路放電特性

Closed Circuit Voltage by Temperature

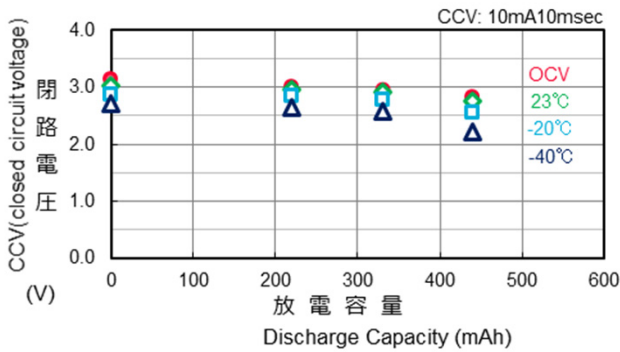

■ 内部抵抗

Impedance by Temperature

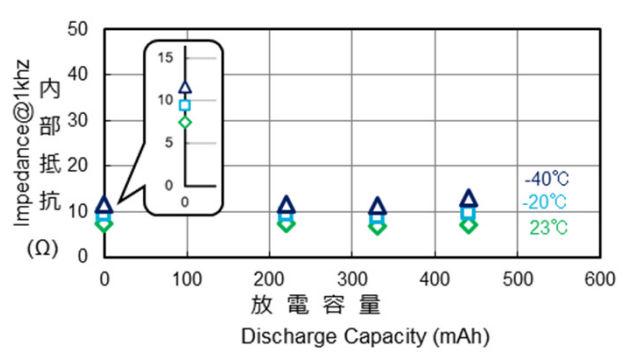

試験方法 / Test method

未放電の電池と規定の容量(330mAh,440mAh @23°C,3kΩ)まで放電させた電池を10mA×10msec(1パルス)の条件で測定した際の電圧値。  
Voltage when the Non-discharged battery and the battery discharged to the specific capacity(330mAh,440mAh @23°C,3kΩ) is measured under the condition of 10mA × 10msec (1 pulse).

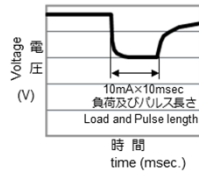

■ 自己放電特性

Self Discharge Characteristic by Temperature

注：20°C未満の自己放電率は20°Cと同じ自己放電率になります。  
Note: The self-discharge rate of less than 20°C shows the same self-discharge rate as 20°C.

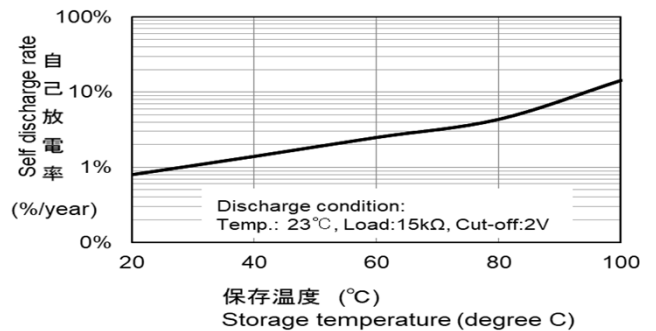

\*記載のデータ及び数値は、参考値であり保証値ではありません。

\*Data is not guaranteed, and is provided for reference purposes only.