

Product Description

The **MYMGA5R03ECLA5RA** is miniature MonoBK™ called “Mono Block”, non-isolated Point-of-Load (PoL) DC-DC power converters for embedded applications.

The small form factor measures only 10.5 x 9.0 x 5.6mm.

The converters have input voltage ranges of 8.0 to 28.8V (absolute maximum input voltage: 40.0V) and a maximum output current of 3.5A. The PoL module features settable output voltage 3.3 to 5.0V, On/Off control and Power Good (PGOOD) signal output. This product also includes under voltage lock out (UVLO), output short circuit protection (SCP), over-current protection (OCP).

Features

- Input voltage ranges from 8.0 to 28.8V (Absolute maximum input voltage: 40.0V)
- Settable output voltage from 3.3 to 5.0V
- Up to 4A of output current (8.0-16.0V_{IN}: 4A, 16.0-28.8V_{IN}: 3.5A)
- Quick response to load change
- Ultra small surface mount package 10.5 x 9.0 x 5.6mm
- High efficiency of 96%(max), 93%(24.0V_{in}/5.0V_{out}/3.5A_{out})
- Outstanding thermal derating performance
- Over Current protection (OCP)
- Short circuit protection (SCP)
- On/Off control (Positive logic)
- Power Good (PGOOD) signal

Typical Applications

- PCIe / Server applications
- FPGA and DSP
- Datacom / Telecom systems
- Distributed bus architectures (DBA)
- Programmable logic and mixed voltage

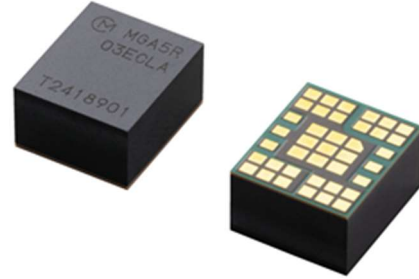

Efficiency

V_{IN} = 24.0V, V_{OUT} = 5.0V, T_A = 25degC

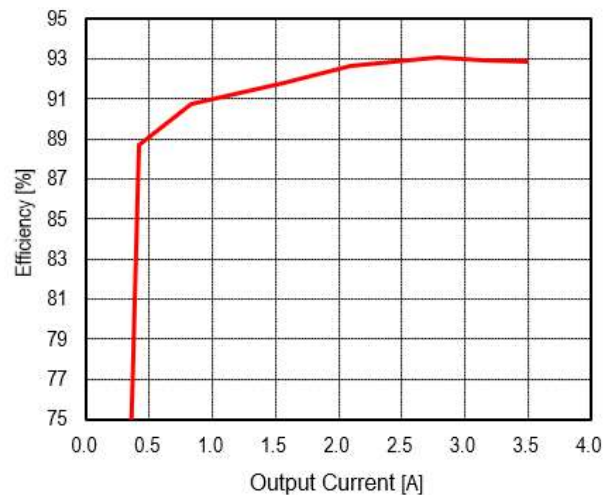

Figure 1. Efficiency Curve

Simplified Application Circuit

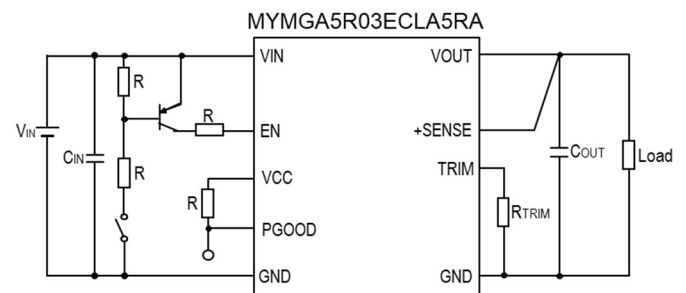

Figure 2. Simplified Circuit Diagram

Product Description	1
Features	1
Typical Applications	1
Simplified Application Circuit	1
Performance Specifications Summary and Ordering Information	3
Top Marking Specifications	3
Pin Configuration	4
Pin Function and Descriptions	4
Absolute Maximum Ratings	5
Recommended Operating Conditions	5
Package Thermal Characteristics	5
Electrical Characteristics	6
Electrical Characteristics Table.....	6
Typical Performance Characteristics	8
Thermal Deratings (Reference Data).....	12
Transient Response Data	12
Test Circuit	13
Detailed Description	14
Light-Load Operation	14
Input Under-Voltage Shutdown and Start-Up Threshold.....	14
Start-Up Time	14
Output Noise	15
Minimum Output Loading Requirements	15
Thermal Shutdown	15
Temperature Derating Curves	15
Output Current Limiting.....	15
Output Short Circuit Condition	16
Power Good (PGOOD)	16
Enable (EN).....	16
Output Capacitive Load.....	16
Output Voltage Adjustment	17
Output Voltage Remote Sense	17
Application Information	18
Application Circuit	18
Application Circuit Part List	18
Example of Pattern Layout (Top View)	19
Application Board Example.....	19
Component Selection	20
Input Fuse	20
Recommended Input Filtering.....	20
Recommended Output Filtering.....	20
Packaging Information	21
Package Drawing	21
Recommended Board Land Pattern (Top View).....	22
Tape and Reel Information	23
Tape Dimension	23
Reel Dimension	23
Tape Specifications.....	24
Soldering Guidelines	24
Recommended Lead-free Solder Reflow Profile	25
Pb-free Solder Processes	25
Dry Pack Information.....	25

Notices	26
Scope	26
Limitation of Applications	26
Fail-safe function	27
Product Specification	27
Contact form	27
Disclaimers	28
Patent Statement	28
Copyright and Trademark.....	28

Performance Specifications Summary and Ordering Information

Table 1. Performance Specifications Summary and Ordering Information

PART NUMBER	OUTPUT		INPUT			Efficiency [%]	EN	Package [mm]	MSL	Quantity/Packing
	V _{OUT} [V]	I _{OUT} (max.) [A]	V _{IN} (typ.) [V]	Range [V]	I _{IN} full load [A]					
MYMGA5R03ECLA5RA	3.3-5.0	4.0	12	8.0-16.0	1.78	94	Yes (Positive)	10.5 x 9.0 x 5.6 LGA	3	400 units/T&R
	3.3-5.0	3.5	24	16.0-28.8	0.83	93				
MYMGA5R03ECLA5RAD	3.3-5.0	4.0	12	8.0-16.0	1.78	94	Yes (Positive)	10.5 x 9.0 x 5.6 LGA	3	100 units/T&R
	3.3-5.0	3.5	24	16.0-28.8	0.83	93				

1. All specifications are at typical line voltage, V_{OUT} = 5.0V and full load, 25degC unless otherwise noted. Output capacitors are 22uF x 5 ceramic. Input capacitors are 10uF x 2 ceramic and plenty electrolytic capacitors. See detailed specifications. Input and Output capacitors are necessary for our test equipment.

2. Use adequate ground plane and copper thickness adjacent to the converter.

Table 2. Part Numbering

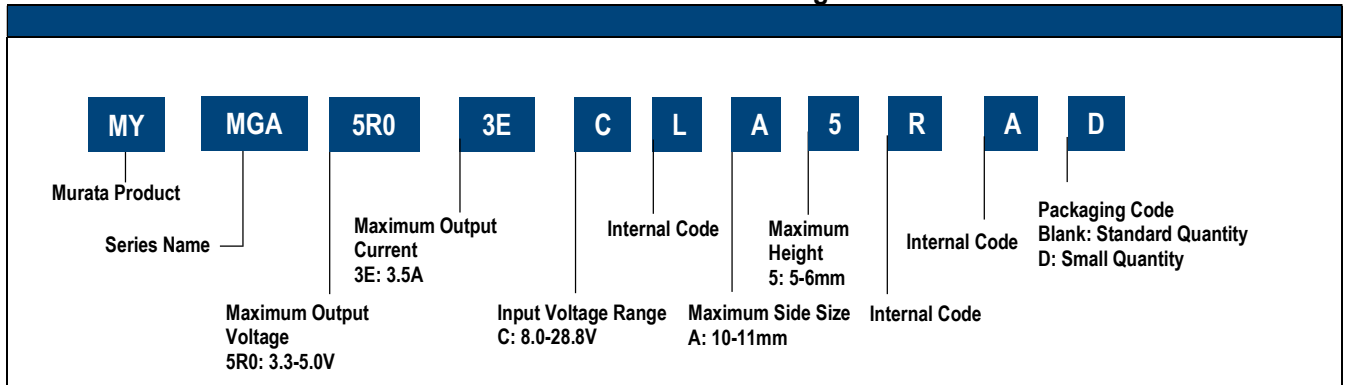

Top Marking Specifications

Because of the small size of these products, the product marking contains a character-reduced code to indicate the model number and manufacturing date code. Not all items on the marking are always used. Please note that the marking differs from the product photograph. Here is the layout of the marking.

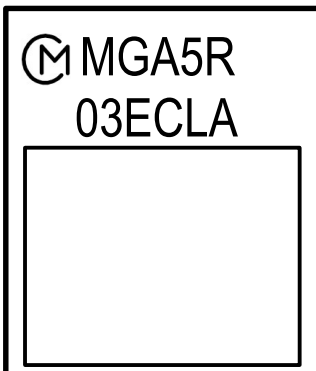

Figure 3. Top Marking Specification

Table 3. Code Description

CODE	DESCRIPTION
Ⓜ	Pin 1 Marking
MGA5R03ECLA	Product code (Please see product code table beside)
[]	Internal manufacturing code

Table 4. Product Code Table

PART NUMBER	PRODUCT CODE
MYMGA5R03ECLA5RA	MGA5R03ECLA
MYMGA5R03ECLA5RAD	MGA5R03ECLA

Pin Configuration

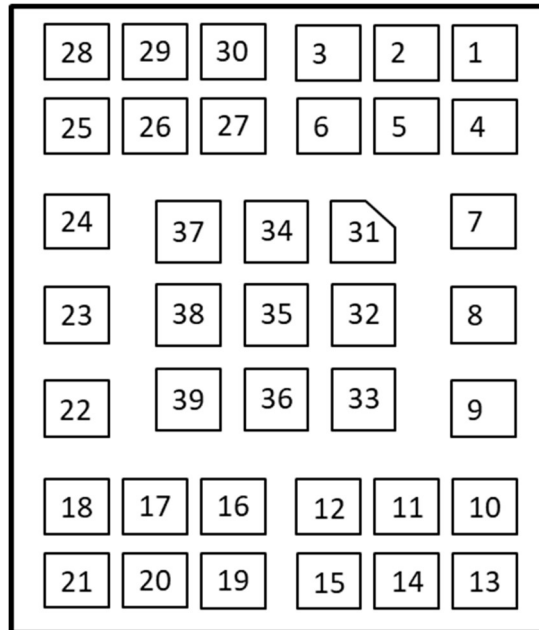

Figure 4. Module Terminals (Bottom View)

Pin Function and Descriptions

Table 5. Pin Function and Descriptions

PIN No.	NAME	FUNCTION and DESCRIPTION
1-6	VIN	Power input voltage.
7	PGOOD	Power good output. The output of PGOOD is an open-drain signal. PGOOD pin needs to be pulled up VCC. The pull-up resistor is recommended 100kohm(±5%) in case that the PGOOD is pulled up to VCC.
8	VCC	Internal Bias Supply. 4.85V(typ.)
9	EN	Remote ON/OFF pin.
10-15, 23, 25-39	GND	Ground pins. Connect to the GND plane.
16-21	VOUT	Power output voltage.
22	+SENSE	Output voltage sense positive return. Connect VOUT and +SENSE to the output voltage sense of the load directly.
24	TRIM	Trimming pin. Connect to the resistor to adjust to the target output voltage.

Absolute Maximum Ratings ⁽¹⁾⁽²⁾

Table 6. Absolute Maximum Ratings

PARAMETER	MIN	MAX	UNITS
V _{IN}	-0.3	40	V
PGOOD, EN, TRIM	-0.3	5.4	V
Output Current (I _{OUT}) V _{in} : 8.0-16.0V	0	4.0	A
Output Current (I _{OUT}) V _{in} : 16.0-28.8V	0	3.5	A
Storage Temperature (T _{stg})	-40	125	degC
Soldering / Reflow Temperature ⁽³⁾	-	245	degC
Maximum Number of Reflows Allowed	-	1	
ESD Tolerance, HBM ⁽⁴⁾	-	±1000	V

Notes:

(1) The application of any stress beyond those listed under "Absolute Maximum Ratings" may cause permanent damage to the device, and exposure at any of these ratings for extended periods may reduce the reliability of the device. The above "Absolute Maximum Ratings" are stress ratings only; the notation of these conditions does not imply functional operation of the device at these or any other conditions that fall outside of the range identified by the operational sections of this specification.

(2) All Voltage are with respect to GND plane.

(3) Recommended Reflow profile is written in "Soldering Guidelines".

(4) Human body model, per the JEDEC standard JS-001-2012.

Recommended Operating Conditions ⁽¹⁾

Table 7. Recommended Operating Conditions

PARAMETER	MIN	MAX	UNITS
Input Voltage (V _{IN})	7.5	15	V
Ambient Temperature (T _A) ⁽²⁾	-40	115	degC
Junction Temperature (T _J) ⁽²⁾	-40	120	degC
Output Current (I _{OUT}) V _{in} : 8.0-16.0V	0	4.0	A
Output Current (I _{OUT}) V _{in} : 16.0-28.8V	0	3.5	A

Notes:

(1) Device should not be operated outside the operating conditions. The reliability is tested at the maximum voltage of the recommended operating condition. Above of recommended operation may reduce reliability of the device.

(2) See the temperature derating curves in the thermal deratings. However, do not condensate.

Package Thermal Characteristics

Table 8. Package Thermal Characteristics

PARAMETER	CONDITIONS	TYP	UNITS
Junction-to-top Characterization Parameter (Ψ _{JT})	V _{IN} = 24V, V _{OUT} = 5.0V, I _{OUT} = 3.5A	1.0	degC/W

Notes:

(1) The thermal resistance is only reference data, and it is measured with our evaluation board as below.
50.8mm x 60.0mm x 1.6mm (4Layers, 35um copper each) FR-4.

Electrical Characteristics⁽¹⁾

Electrical Characteristics Table

$V_{IN} = 24.0V$, $V_{OUT} = 5.0V$, $I_{OUT} = 3.5A$, $T_A = 25degC$, unless otherwise noted

Table 9. Electric Characteristics Table

PARAMETER	SYMBOL	CONDITIONS	MIN	TYP	MAX	UNITS
INPUT SUPPLY						
Input Voltage	V_{IN}		8.0	24	28.8	V
V_{IN} Under Voltage Lockout Threshold, V_{IN} Rising	V_{IN_UVH}	$I_{OUT} = 0A$	-	4	-	V
V_{IN} Under Voltage Lockout Threshold, V_{IN} Falling ⁽¹⁰⁾	V_{IN_UVL}	$I_{OUT} = 0A$	-	3.1	-	V
V_{IN} Current Supply, Full load	I_{IN_FULL}	$V_{IN} = 24.0V$, $V_{OUT} = 5.0V$, $I_{OUT} = 3.5A$	-	0.83	-	A
V_{IN} Current Supply, Switching	I_{IN_SW}	$V_{IN} = 24.0V$, $V_{OUT} = 5.0V$, $I_{OUT} = 0A$	-	5	-	mA
ENABLE INPUT (EN PIN)						
Threshold High	V_{TH_ENH}		2.15	-	-	V
Threshold Low	V_{TH_ENL}		-	-	1.2	V
EN Pin Input Current	I_{EN}	$V_{EN} = 2.0V$	-	1.5	-	uA
CONVERTER						
Efficiency	EFF	$V_{IN} = 24.0V$, $V_{OUT} = 5.0V$, $I_{OUT} = 3.5A$	-	93	-	%
		$V_{IN} = 12.0V$, $V_{OUT} = 5.0V$, $I_{OUT} = 4A$	-	94	-	
Fixed Switching Frequency	F_{SW}		-	400	-	kHz
Start-up Time	T_{START_UP}	$V_{OUT} = 5.0V$, $C_{OUT} = 110uF$ ($V_{OUT}=5\%$ to 90% of V_{OUT})	-	3.6	-	ms
POWER GOOD (PGOOD PIN)⁽⁴⁾						
PGOOD TRUE (HI)	V_{TH_PGH}		-	93	-	% of V_{OUT}
PGOOD FALSE (LO)	V_{TH_PGL}		-	85	-	% of V_{OUT}
OUTPUT⁽¹³⁾						
Output Current ⁽²⁾	I_{OUT}	$V_{in}: 8.0-16.0V$	0	-	4	A
		$V_{in}: 16.0-28.8V$	0	-	3.5	A
Output Voltage ⁽⁸⁾	V_{OUT}		3.3	-	5.0	V
Total Output Voltage Accuracy ⁽⁷⁾⁽¹¹⁾	V_{OUT_ACC}	$V_{IN} = 12.0V$, $V_{OUT} = 3.3-5.0V$, I_{OUT} : at PWM mode, $T_A = -40-115degC$	-4.0	-	+4.0	%
		$V_{IN} = 24.0V$, $V_{OUT} = 3.3-5.0V$, I_{OUT} : at PWM mode, $T_A = -40-115degC$	-4.0	-	+4.0	%
Line Regulation ⁽¹¹⁾	V_{OUT_LINE}	$V_{IN} = 8.0-16.0V$, $V_{OUT} = 3.3-5.0V$, $I_{OUT} = 4.0A$, $T_A = 25degC$	-	± 1.25	-	%
		$V_{IN} = 24.0-28.8V$, $V_{OUT} = 3.3-5.0V$, $I_{OUT} = 3.5A$, $T_A = 25degC$	-	± 0.75	-	%
Load Regulation ⁽¹¹⁾	V_{OUT_LOAD}	$V_{IN} = 12.0V$, $V_{OUT} = 3.3-5.0V$, I_{OUT} : at PWM mode, $T_A = 25degC$	-	± 0.25	-	%
		$V_{IN} = 24.0V$, $V_{OUT} = 3.3-5.0V$, I_{OUT} : at PWM mode, $T_A = 25degC$	-	± 0.25	-	%
Temperature Variation ⁽¹¹⁾	V_{OUT_TEMP}	$V_{IN} = 12.0V$, $V_{OUT} = 3.3-5.0V$, I_{OUT} $= 4.0A$, $T_A = -40-115degC$	-	± 0.75	-	%
		$V_{IN} = 24.0V$, $V_{OUT} = 3.3-5.0V$, I_{OUT} $= 3.5A$, $T_A = -40-115degC$	-	± 0.75	-	%
Dynamic Load Peak Deviation	V_{OUT_DYN}	$I_{OUT} = 50-100\%$, $1A/us$	-	± 2.0	-	%

PARAMETER	SYMBOL	CONDITIONS	MIN	TYP	MAX	UNITS
Ripple and Noise (20MHz bandwidth) ⁽⁶⁾	V _{RIP}		-	1	-	% of V _{out}
External Output Capacitance Range ⁽⁹⁾	C _{OUT}		110	-	470	uF
PROTECTION						
Over Current Protection Threshold	I _{OCPTH}	HICCUP operating ⁽⁵⁾	-	6	-	A
Short Circuit Protection Method			HICCUP ⁽⁵⁾			
Thermal Protection ⁽¹²⁾	T _{OTPTH}	Shutdown operating	-	175	-	degC
Thermal Protection Hysteresis ⁽¹²⁾			-	45	-	degC
ENVIRONMENTAL						
Moisture Sensitivity Level			3			
Calculated MTBF ⁽³⁾		T _A = 40degC, I _{OUT} = 50%	-	2.25x 10 ⁶	-	hours

Notes

- (1) Specifications are typical at 25degC, V_{IN} = 24.0V, V_{OUT} = 5.0V, full load, external capacitors and natural convection unless otherwise indicated. All model is tested and specified with external 22uF x 5 ceramic output capacitors, 10uF x 2 ceramic and plenty electrolytic external input capacitors. All capacitors are low ESR types. These capacitors are necessary to accommodate our test equipment and may not be required to achieve specified performance in your applications. However, Murata recommends installation of these capacitors. Please refer the test circuit.
- (2) Note that Maximum Power Derating curves indicate an average current at typical input voltage. At higher temperatures or no airflow, the converter will tolerate brief full current outputs if the total RMS current over time does not exceed the Derating curve.
- (3) Mean Time Between Failure is calculated using the Telcordia SR-332 method, 40degC, half output load, natural air convection.
- (4) The EN Control Input should use either a switch or an open collector/open drain transistor referenced to GND. A logic gate may also be used by applying appropriate external voltages which do not exceed absolute maximum ratings.
- (5) "Hiccup" overcurrent operation repeatedly attempts to restart the converter with a brief, full-current output. If the overcurrent condition still exists, the restart current will be removed and then tried again. This short current pulse prevents overheating and damaging the converter. Once the fault is removed, the converter immediately recovers normal operation.
- (6) Output noise may be further reduced by adding an external filter. At zero output current, the output may contain low frequency components which exceed the ripple specification. The output may be operated indefinitely with no load.
- (7) Regulation specifications describe the deviation as the line input voltage or output load current is varied from a nominal midpoint value to either extreme without no load and light load.
- (8) Do not exceed maximum power specifications when adjusting the output trim.
- (9) The maximum output capacitive loads depend on the Equivalent Series Resistance (ESR) of the external output capacitor and, to a lesser extent, the distance and series impedance to the load. Larger caps will reduce output noise but may change the transient response. Newer ceramic caps with very low ESR may require lower capacitor values to avoid instability. Thoroughly test your capacitors in the application.
- (10) Do not allow the input voltage to degrade lower than the input under voltage shutdown voltage at all times. Otherwise, you risk having the converter turn off. The Under-voltage shutdown is not latching and will attempt to recover when the input is brought back into normal operating range.
- (11) Ensured by design. Not production tested.
- (12) The temperature is measured with the IC in the center of the converter.
- (13) Please refer to the "Light-Load Operation" section for the point of switching to PWM mode.

Typical Performance Characteristics

In this document, all characteristics are measured with the test board. The schematic and part list of the board are shown in and Table 11. The board is under $T_A = 25\text{degC}$ with no airflow unless otherwise noted.

$V_{IN} = 12.0\text{V}$, $V_{OUT} = 3.3\text{V}$

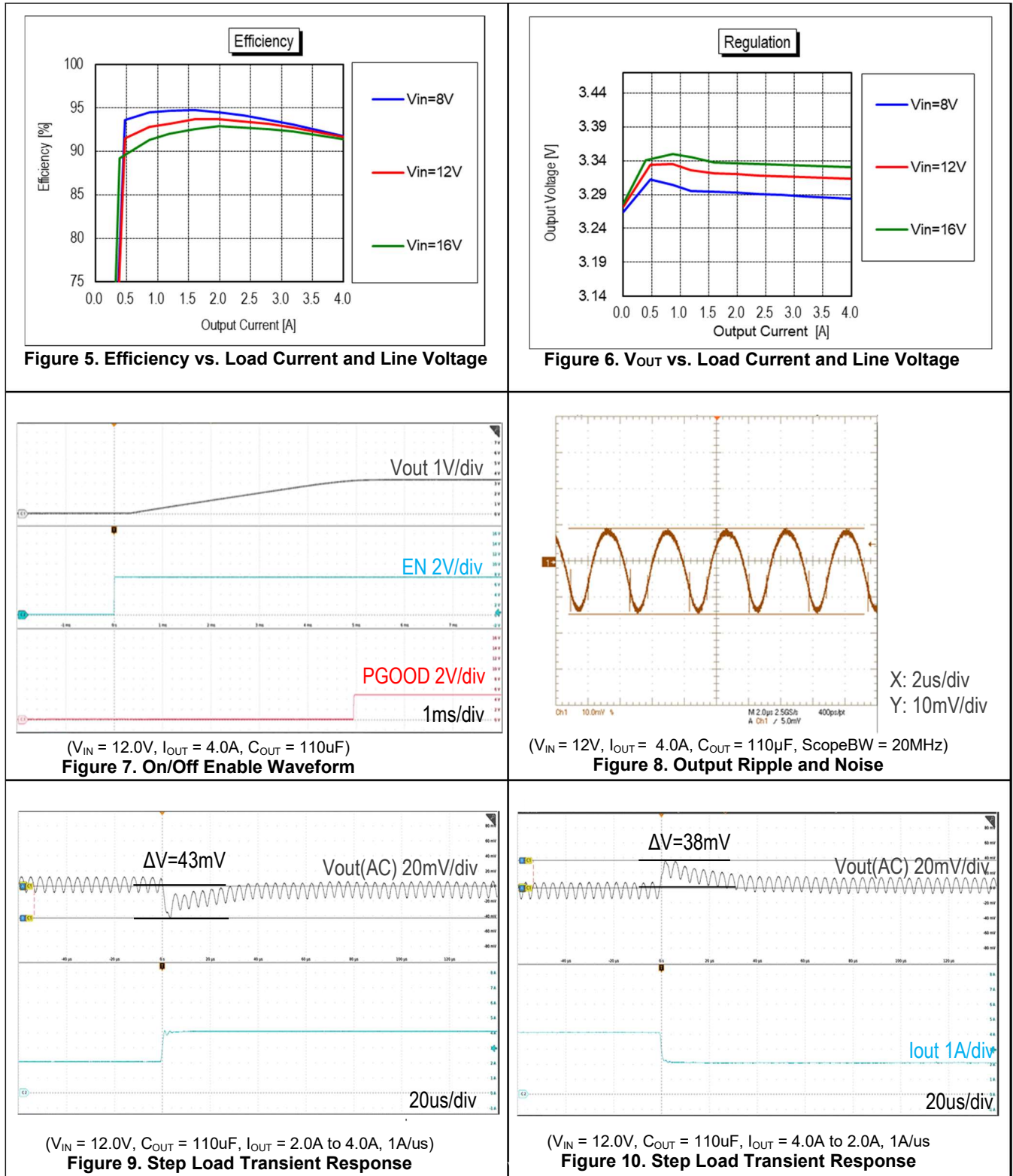

$V_{IN} = 24.0V$, $V_{OUT} = 3.3V$

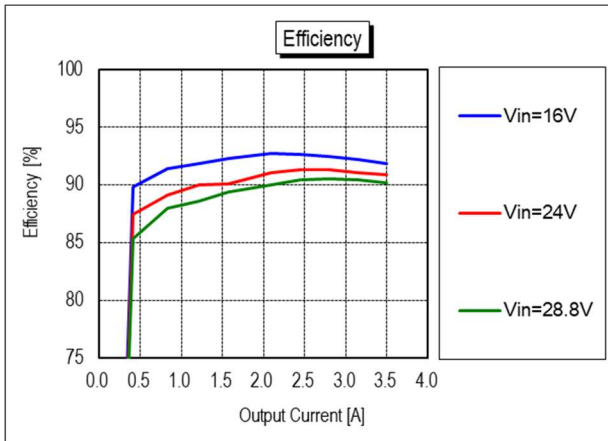

Figure 11. Efficiency vs. Load Current and Line Voltage

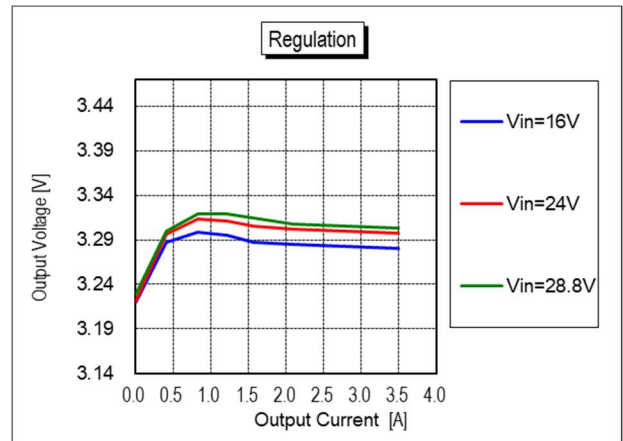
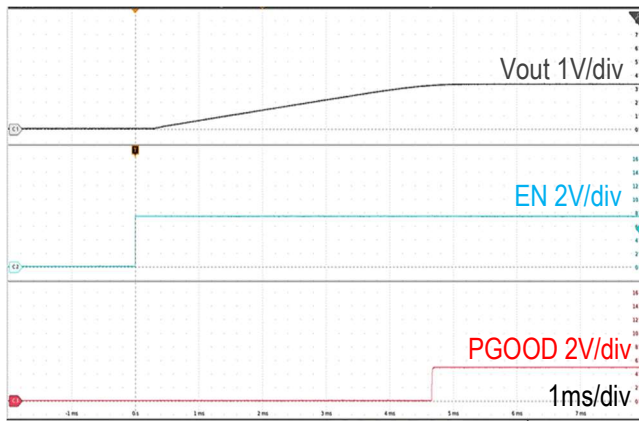
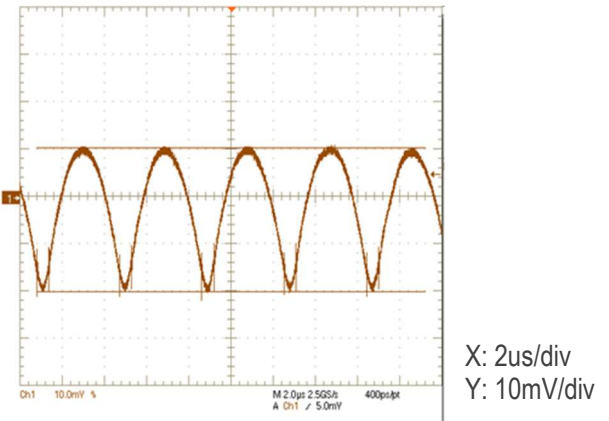

Figure 12. V_{OUT} vs. Load Current and Line Voltage



($V_{IN} = 24.0V$, $I_{OUT} = 3.5A$, $C_{OUT} = 110\mu F$)
Figure 13. On/Off Enable Waveform



($V_{IN} = 24V$, $I_{OUT} = 3.5A$, $C_{OUT} = 110\mu F$, ScopeBW = 20MHz)
Figure 14. Output Ripple and Noise

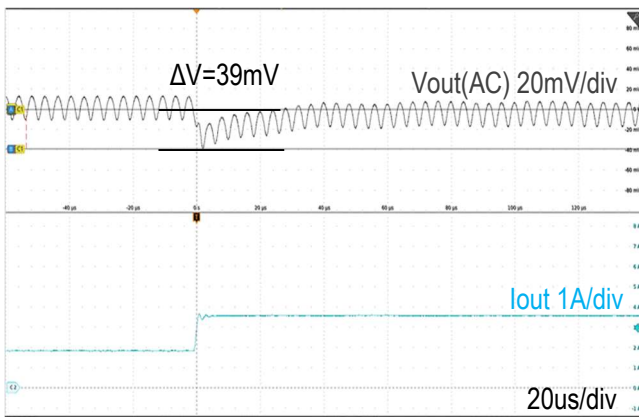

($V_{IN} = 24.0V$, $C_{OUT} = 110\mu F$, $I_{OUT} = 1.75A$ to $3.5A$, $1A/\mu s$)
Figure 15. Step Load Transient Response

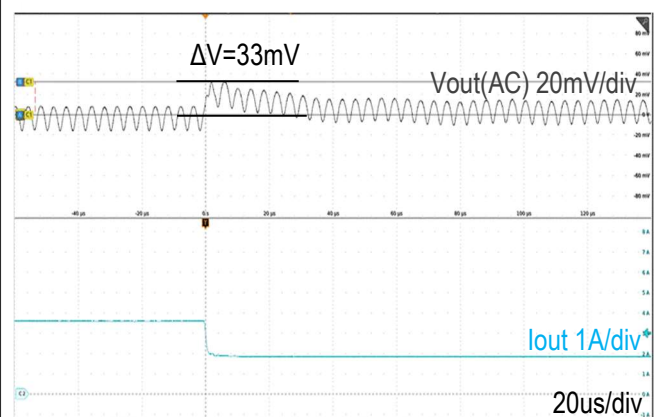

($V_{IN} = 24.0V$, $C_{OUT} = 110\mu F$, $I_{OUT} = 3.5A$ to $1.75A$, $1A/\mu s$)
Figure 16. Step Load Transient Response

$V_{IN} = 12.0V$, $V_{OUT} = 5.0V$

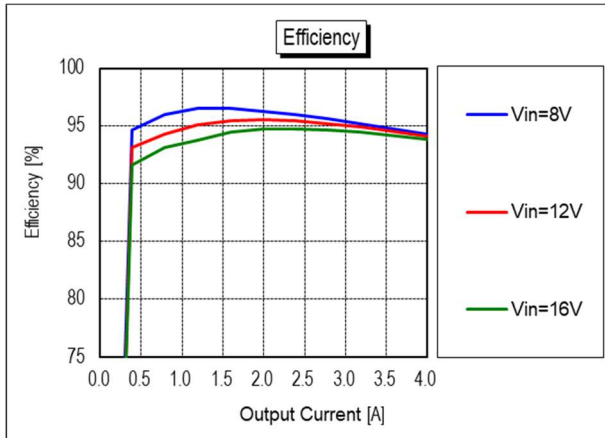

Figure 17. Efficiency vs. Load Current and Line Voltage

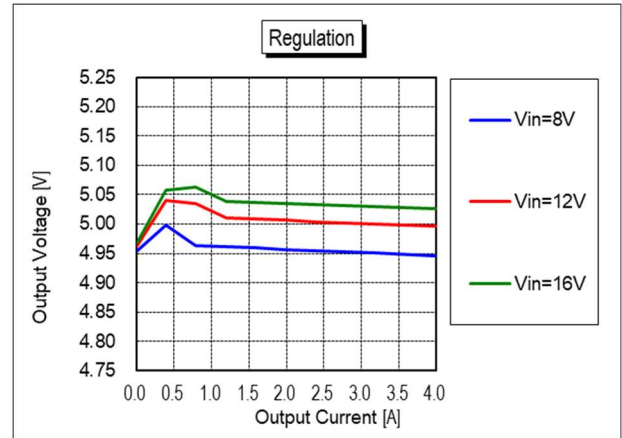

Figure 18. V_{OUT} vs. Load Current and Line Voltage

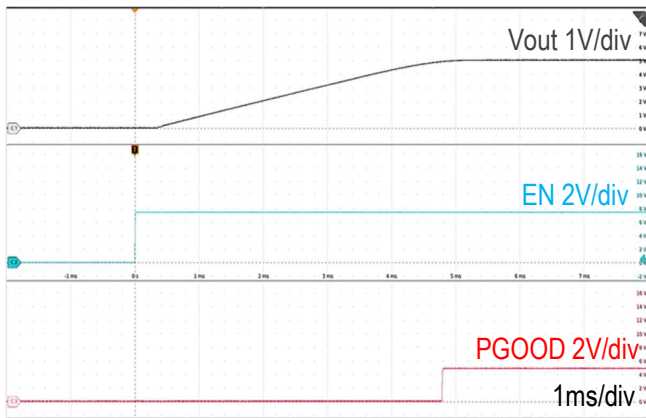

Figure 19. On/Off Enable Waveform

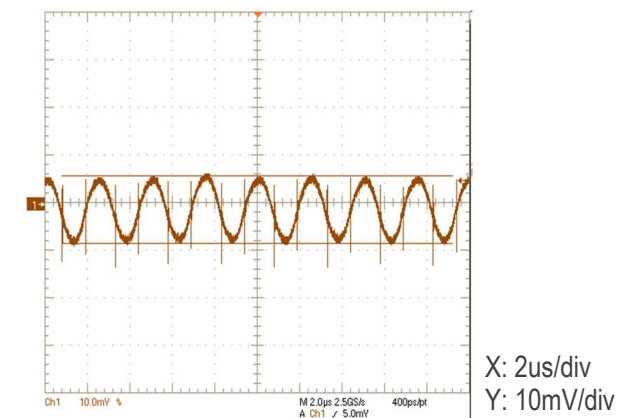

Figure 20. Output Ripple and Noise

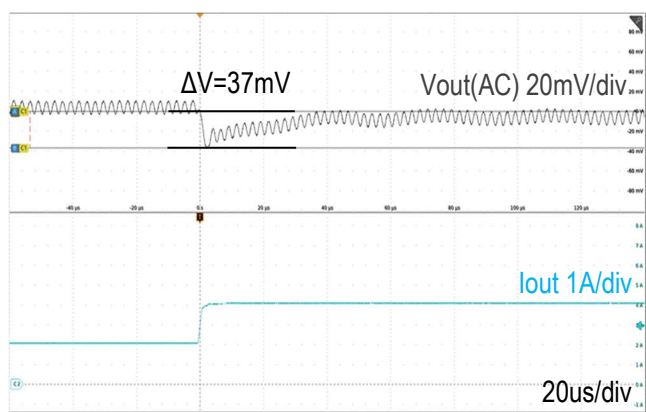

Figure 21. Step Load Transient Response

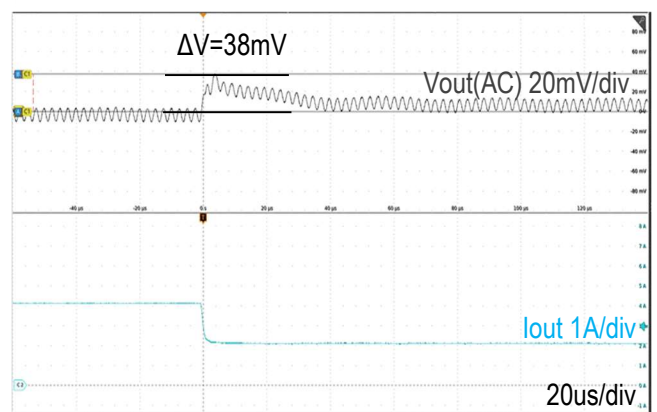

Figure 22. Step Load Transient Response

$V_{IN} = 24.0V$, $V_{OUT} = 5.0V$

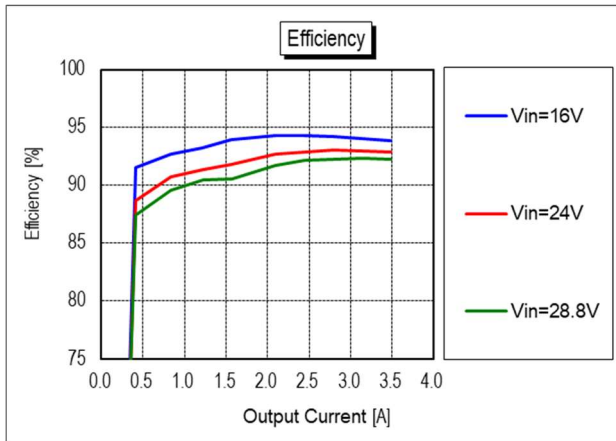

Figure 23. Efficiency vs. Load Current and Line Voltage

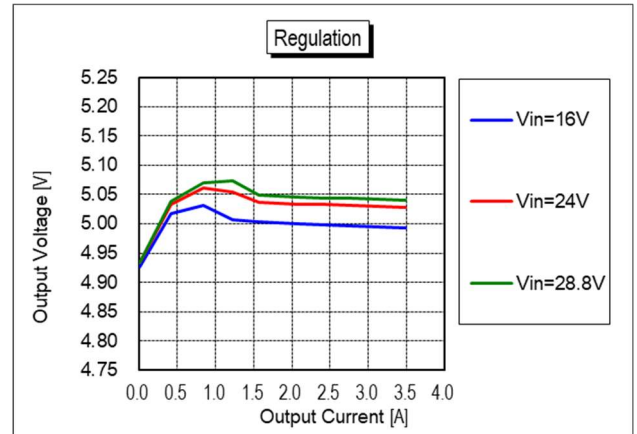
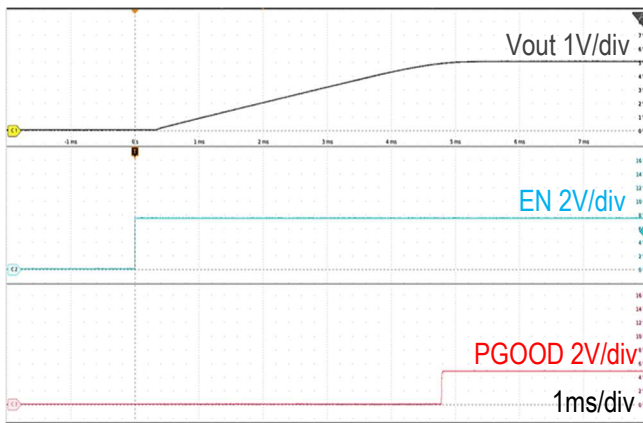
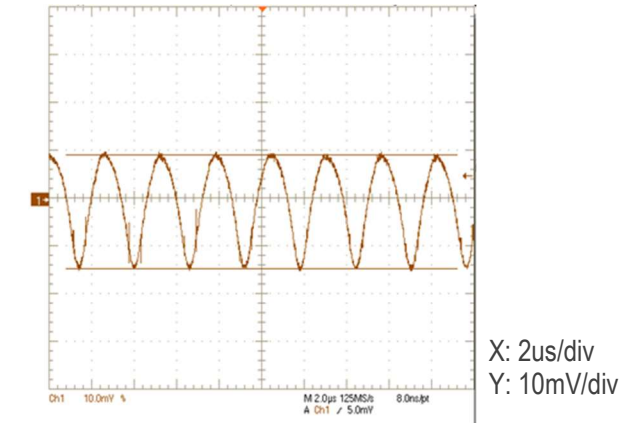

Figure 24. V_{OUT} vs. Load Current and Line Voltage



($V_{IN} = 24.0V$, $I_{OUT} = 3.5A$, $C_{OUT} = 110\mu F$)
Figure 25. On/Off Enable Waveform



($V_{IN} = 24V$, $I_{OUT} = 3.5A$, $C_{OUT} = 100\mu F$, ScopeBW = 20MHz)
Figure 26. Output Ripple and Noise

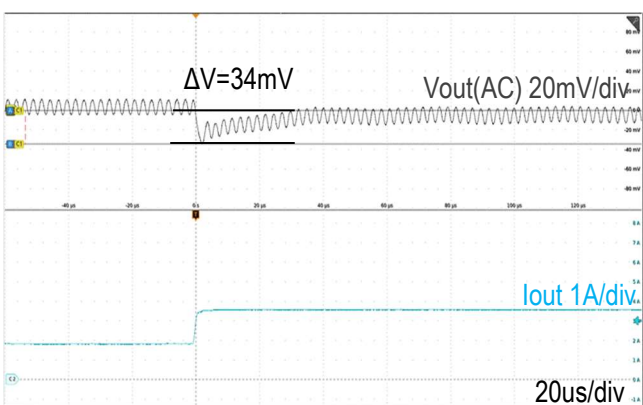

($V_{IN} = 24.0V$, $C_{OUT} = 110\mu F$, $I_{OUT} = 1.75A$ to $3.5A$, $1A/\mu s$)
Figure 27. Step Load Transient Response

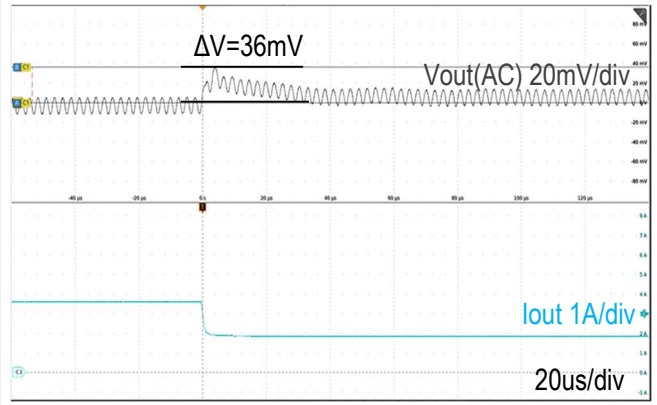

($V_{IN} = 24.0V$, $C_{OUT} = 110\mu F$, $I_{OUT} = 3.5A$ to $1.75A$, $1A/\mu s$)
Figure 28. Step Load Transient Response

Thermal Deratings (Reference Data)

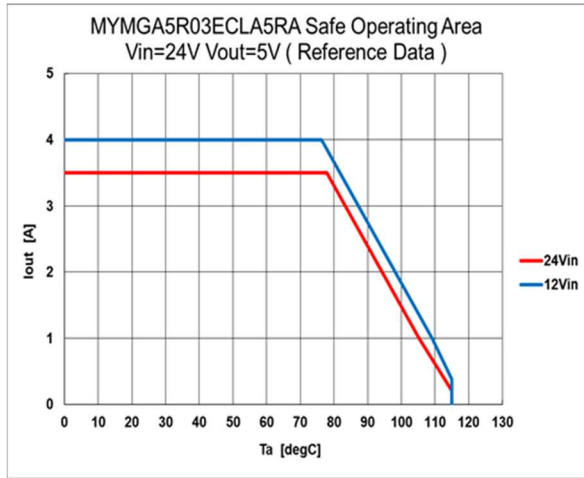

Figure 29. Safe Operating Area



Position: Center of the Module
Radius: 1mm

Figure 30. Temperature Measuring Area

Thermal deratings are evaluated in following condition.

- The product is mounted on 60.0mm x 50.8mm x 1.6mm (4 Layer, 35um copper each) FR-4 board respectively.
- No forced airflow.

Transient Response Data

Transient response data at various conditions are showed in following table.

Minimum output capacitance can serve less than 2% x V_{OUT} of deviation for the load change in the following figure.

Table 10. Transient Response Data

V _{OUT} [V]	V _{IN} [V]	C _{OUT} [uF]	I _{OUT} Load Step [A], 1A/us	VOLTAGE DEVIATION [mV]
3.3	12	110	2.0-4.0	43
5				38
3.3	24	110	1.75-3.5	39
5				36

Test Circuit

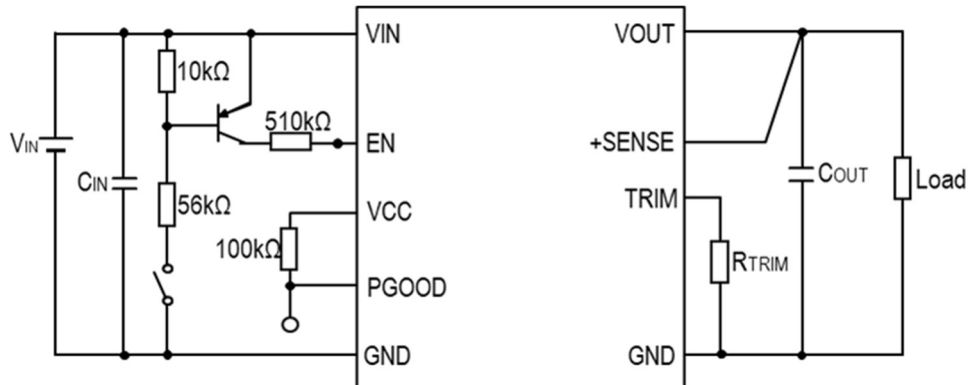

Figure 31. Test Circuit

V_{IN}: DC Power Supply

Load: Electronic Load Device

C_{IN}: 10μF/50V × 2pcs (GRM32ER71H106KA12: Murata)

C_{OUT}: 22μF/10V × 5pcs (GRM31CR71A226KE15: Murata)

*Do not connect any additional components between the TRIM pin and VOUT or between the TRIM and +SENSE pins. Use only the specified connections.

Detailed Description

Light-Load Operation

At light-load or no-load conditions, the output drops very slowly, and this product reduces the switching frequency automatically to maintain high efficiency.

As the output current increases from light-load condition, the current modulator's regulatory time period becomes shorter. The HS-FET turns ON more frequently, thus increasing the switching frequency increases. The output current reaches its critical level when the current modulator time is zero. The critical output current level is:

$$I_{OUT}[A] = \frac{(V_{IN}-V_{OUT}) \times V_{OUT}}{1.66 \times V_{IN}} \quad (1)$$

$$F_{SW}[kHz] = \frac{10^6}{\left(\frac{12500}{V_{IN}} + 20\right) \times \frac{V_{IN}}{V_{OUT}}} \quad (2)$$

It enters PWM mode once the output current exceeds the critical level. After that, the switching frequency stays fairly constant over the output current range.

Input Under-Voltage Shutdown and Start-Up Threshold

Under normal start-up conditions, converters will not begin to regulate properly until the ramping-up input voltage exceeds and remains at the Start-Up Threshold Voltage (see Specifications). Once operating, converters will not turn off until the input voltage drops below the Under-Voltage Shutdown Limit. Subsequent restart will not occur until the input voltage rises again above the Start-Up Threshold. This built-in hysteresis prevents any unstable EN operation at a single input voltage.

Users should be aware however of input sources near the Under-Voltage Shutdown whose voltage decays as input current is consumed (such as capacitor inputs), the converter shuts off and then restarts as the external capacitor recharges. Such situations could oscillate. To prevent this, make sure the operating input voltage is well above the UV Shutdown voltage at all times.

Start-Up Time

Assuming that the output current is set at the rated maximum, the V_{IN} to V_{OUT} Start-Up Time (see Specifications) is the time interval between the point when the ramping input voltage crosses the Start-Up Threshold and the fully loaded regulated output voltage enters and remains within its specified accuracy band. Actual measured times will vary with input source impedance, external input capacitance, input voltage slew rate and final value of the input voltage as it appears at the converter.

This converter includes a soft start circuit to moderate the duty cycle of its PWM controller at power up, thereby limiting the input inrush current.

The EN Remote Control interval from ON command to V_{OUT} regulated assumes that the converter already has its input voltage stabilized above the Start-Up Threshold before the ON command. The interval is measured from the ON command until the output enters and remains within its specified accuracy band. The specification assumes that the output is fully loaded at maximum rated current. Similar conditions apply to the ON to V_{OUT} regulated specification such as external load capacitance and soft start circuitry.

Output Noise

This converter is tested and specified for output noise using designated external output components, circuits and layout as shown in the figures below. In the figure below, the two copper strips simulate real-world printed circuit impedances between the power supply and its load. In order to minimize circuit errors and standardize tests between units, scope measurements should be made using BNC connectors or the probe ground should not exceed one half inch and soldered directly to the test circuit.

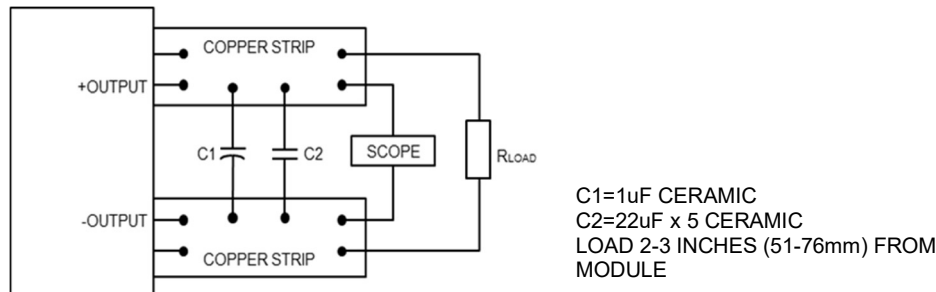

Figure 32. Circuits and Layout

Minimum Output Loading Requirements

This converter regulates within specification and are stable under no load to full load conditions. Operation under no load might slightly increase output ripple and noise.

Thermal Shutdown

To prevent many over temperature problems and damage, these converters include thermal shutdown circuitry. If environmental conditions cause the temperature of the converter to rise above the Operating Temperature Range up to the shutdown temperature, an on-board electronic temperature sensor will shut down the unit. When the temperature decreases below the turn-on threshold, the converter will automatically restart.

CAUTION: If you operate too close to the thermal limits, the converter may shut down suddenly without warning. Be sure to thoroughly you're your application to avoid unplanned thermal shutdown.

Temperature Derating Curves

The graph in this data sheet illustrates typical operation under a variety of conditions. The derating curves show the maximum continuous ambient air temperature. Note that these are AVERAGE measurements.

Note that the temperatures are of the ambient airflow, not the converter itself which is obviously running at higher temperature than the outside air. Also note that very low flow rates (below about 25 LFM) are similar to "natural convection," that is, not using fan-forced airflow. We use both thermocouples and an infrared camera system to observe thermal performance.

CAUTION: This graph is collected at slightly above Sea Level altitude. Be sure to reduce the derating for higher density altitude.

Output Current Limiting

Current limiting inception is defined as the point at which full power falls below the rated tolerance. See the Performance/Functional Specifications. Note particularly that the output current may briefly rise above its rated value in normal operation as long as the average output power is not exceeded. This enhances reliability and continued operation of your application. If the output current is too high, the converter will enter the short circuit condition.

Output Short Circuit Condition

When a converter is in current-limit mode, the output voltage will drop as the output current demand increases. Following a time-out period, the converter will restart, causing the output voltage to begin ramping up to its appropriate value. If the short-circuit condition persists, another shutdown cycle will initiate. This rapid on/off cycling is called “hiccup mode”. The hiccup cycling reduces the average output current, thereby preventing excessive internal temperatures and/or component damage. A short circuit can be tolerated indefinitely. The “hiccup” system differs from older latching short circuit systems because you do not have to power down the converter to make it restart. The system will automatically restore operation as soon as the short circuit condition is removed.

Power Good (PGOOD)

PGOOD pin needs to be pulled up VCC. The pull-up resistor is recommended 100kohm(±5%). When this product is in following situation, the PGOOD signal appears.

- Output voltage is within voltage detection threshold: PGOOD pin is on open drain.
- Output Voltage is out of voltage detection threshold: PGOOD pin is connected to GND.
- Soft start is active: PGOOD pin is connected to GND.
- An undervoltage condition exists for the DC-DC converter: PGOOD pin is connected to GND.
- An overcurrent condition has been detected: PGOOD pin is connected to GND.
- Die temperature is over: PGOOD pin is connected to GND.

Enable (EN)

By using ON/OFF function, the operation of this product can be disabled without disconnection of input Voltage. Sequence of a power supply system and power-saving control can be easily achieved using this function.

- EN pin are pull-up: Output Voltage = ON
- EN pin are connected to GND: Output Voltage = OFF

It is strongly recommended that on/off terminal should be used when you turn on/off this product. Characteristics may be affected by turning input voltage on/off. Please check product operation on your application with turning.

Output Capacitive Load

Users should only consider adding capacitance to reduce switching noise and/or to handle spike current load steps. Install only enough capacitance to achieve noise objectives. Excess external capacitance may cause regulation problems, degraded transient response and possible oscillation or instability.

Output Voltage Adjustment

The output voltage may be adjusted over a limited range by connecting an external trim resistor (R_{TRIM}) between the Trim pin and GND pin. The R_{TRIM} resistor must be a 1/10W precision metal film type, $\pm 0.5\%$ accuracy or better with low temperature coefficient, $\pm 100\text{ppm}/^\circ\text{C}$. or better. Mount the resistor close to the converter with very short leads or use a surface mount trim resistor.

In the table below, the estimated resistance is given. Do not exceed the specified limits of the output voltage or the converter's maximum power rating when applying these resistors. Also, avoid high noise at the Trim input. However, to prevent instability, you should never connect any capacitors between Trim pin and GND pin.

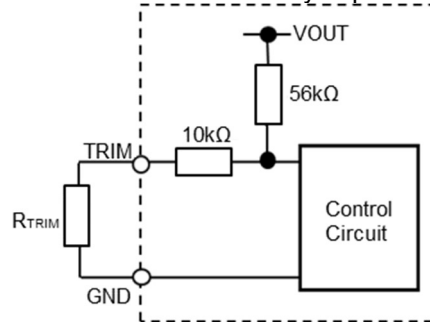

Figure 33. TRIM Internal Circuit Diagram

Table 11. Output Voltage and Rtrim Value

INPUT VOLTAGE	OUTPUT VOLTAGE	ESTIMATED R_{TRIM} [OHM]	
		CALUCRATED R_{TRIM}	R_{TRIM} EXAMPLE
12V(typ.)	3.3	7360	6.8k + 560
	5.0	150	150
24V(typ.)	3.3	7770	7.5k + 270
	5.0	270	270

* Please check output voltage and adjust R_{TRIM} in user circumstances.

Output Voltage Remote Sense

This function is capable to compensate up the voltage drop between the output and input of load. The sense range depend on the maximum voltage allowing on the VOUT pin. The sense trace should be short as possible and shielded by GND line or else to reduce noise susceptibility. The sense line length should be within 10cm for output voltage stability. If the remote sense is not needed, +SENSE pin should be connected to VOUT pin.

Application Information

Application Circuit

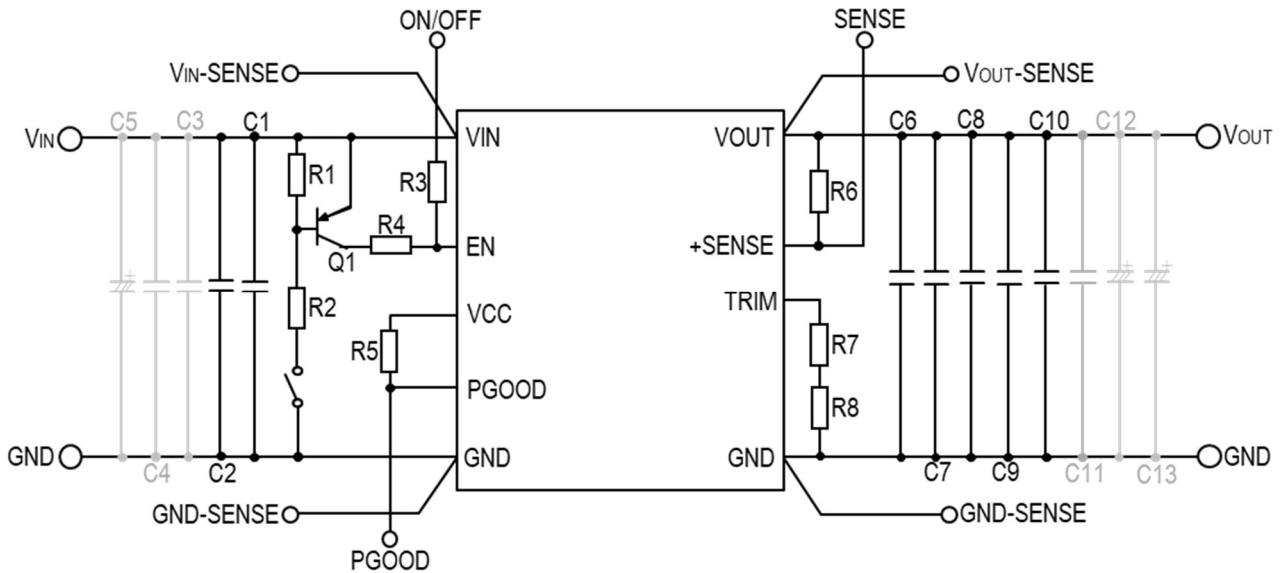

Figure 34. Application Circuit

Application Circuit Part List

An example of the standard components is shown in Table 12. Components must be chosen referring the system requirement such as voltage and temperature.

Table 12. Application Circuit Part List

REFERENCE	VALUE	DESCRIPTION	PART AND EQUIPMENT
C1-C2	10uF	Input Capacitor Ceramic capacitor, 10uF, 50V, ±10%, X7R	GRM32ER71H106KA12 (Murata)
C6-C10	22uF	Output Capacitor Ceramic capacitor, 22uF, 10V, ±10%, X7R	GRM31CR71A226KE15 (Murata)
R1	10kohm	Chip resistor, 1/10W, ±0.5%	RK73H1JTDD1002D (KOA)
R2	56kohm	Chip resistor, 1/10W, ±0.5%	RK73H1JTDD5602D (KOA)
R3	0ohm	Chip resistor	RK73Z1JTDD (KOA)
R4	510kohm	Chip resistor, 1/10W, ±0.5%	RK73H1JTDD5103D (KOA)
R5	100kohm	Chip resistor, 1/10W, ±0.5%	RK73H1JTDD1003D (KOA)
R6	0ohm	Chip resistor	RK73Z1JTDD (KOA)
R7-R8	-	Chip resistor, 1/10W, ±0.5%	Please refer to Table 11.
Q1	-	Transistor	2SA1774FRA (ROHM)

Example of Pattern Layout (Top View)

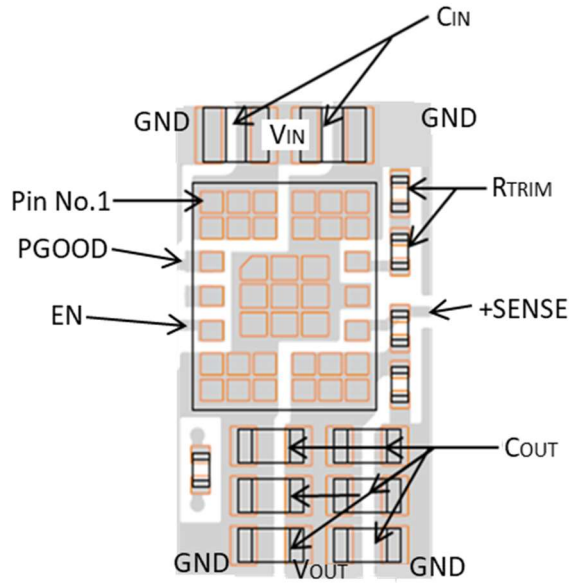

Figure 35. Example of Pattern Layout (Top View)

Application Board Example



Figure 36. Application Board Example

Component Selection

Input Fuse

Certain applications and/or safety agencies may require fuses at the inputs of power conversion components. Fuses should also be used when there is the possibility of sustained input voltage reversal which is not current limited. For greatest safety, we recommend a fast blow fuse installed in the ungrounded input supply line. The installer must observe all relevant safety standards and regulations. For safety agency approvals, install the converter in compliance with the end-user safety standard.

Recommended Input Filtering

The user must assure that the input source has low AC impedance to provide dynamic stability and that the input supply has little or no inductive content, including long distributed wiring to a remote power supply. The converter will operate with no additional external capacitance if these conditions are met. For best performance, we recommend installing a low-ESR capacitor immediately adjacent to the converter's input terminals.

Recommended Output Filtering

The converter will achieve its rated output ripple and noise with additional external capacitor. The user may install more external output capacitance reduce the ripple even further or for improved dynamic response. Again, use low-ESR ceramic (Murata GCM31 series). Initial values of 22uF x 5 ceramic type. Mount these close to the converter. Measure the output ripple under your load conditions.

Use only as much capacitance as required to achieve your ripple and noise objectives. Excessive capacitance can make step load recovery sluggish or possibly introduce instability. Do not exceed the maximum rated output capacitance listed in the specifications.

Packaging Information

This section provides packaging data including the moisture sensitivity level, package drawing, package marking and tape-and-reel information.

Package Drawing

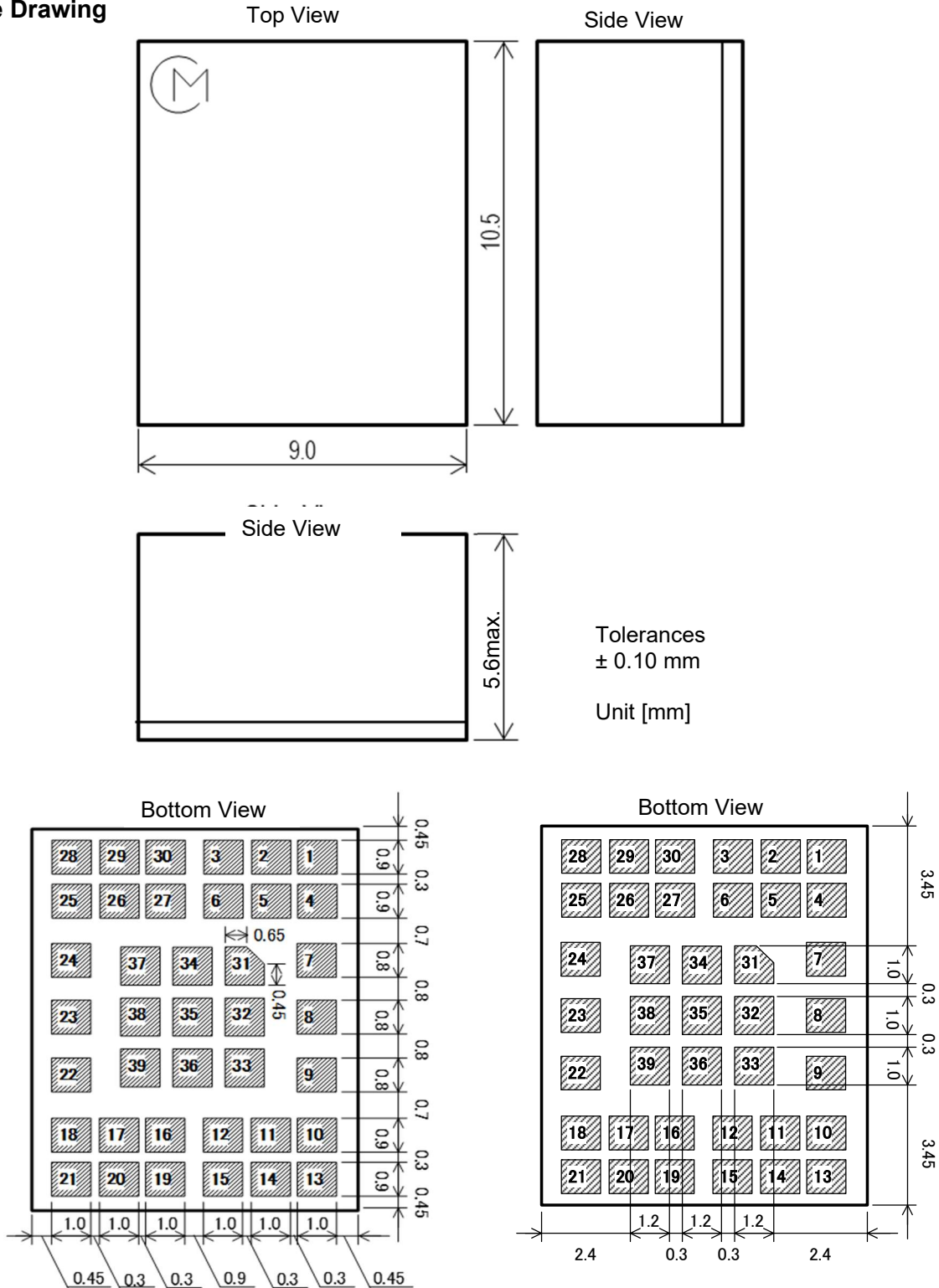

Figure 37. Package Outline Drawing

Recommended Board Land Pattern (Top View)

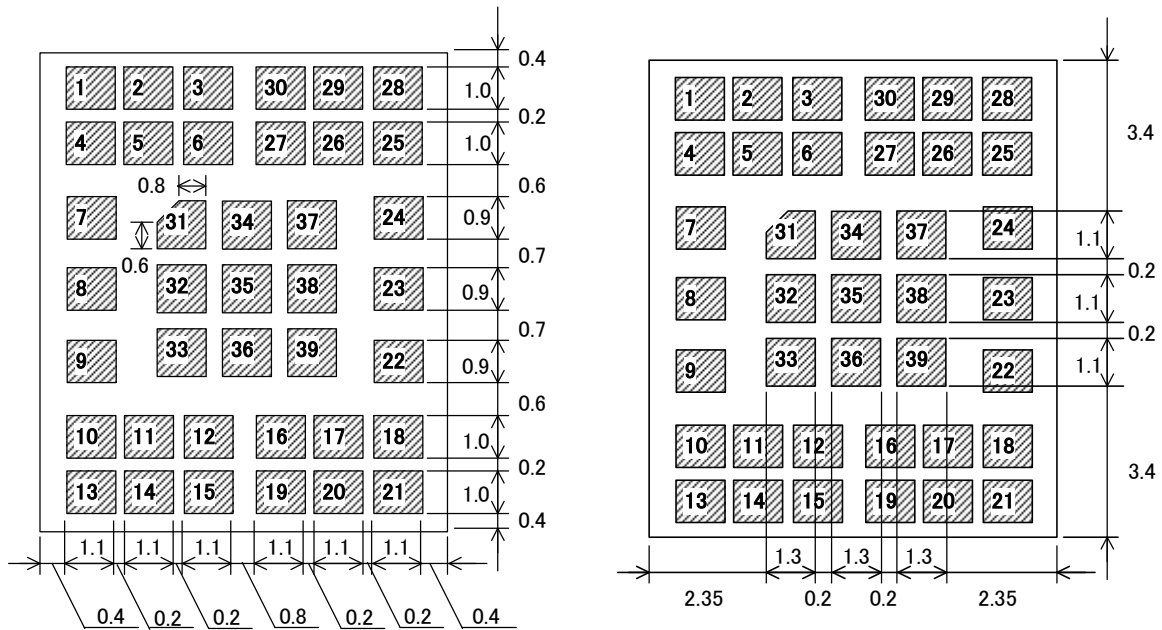

Figure 38. Recommended Board Land Pattern (Top View)

Tape and Reel Information

Tape Dimension

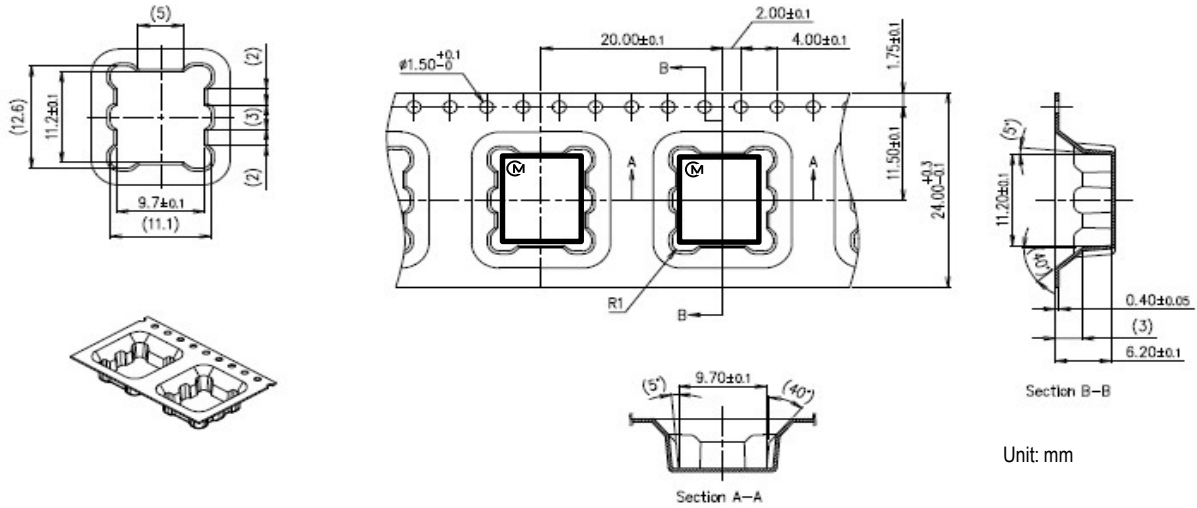

Figure 39. Tape Dimension

Reel Dimension

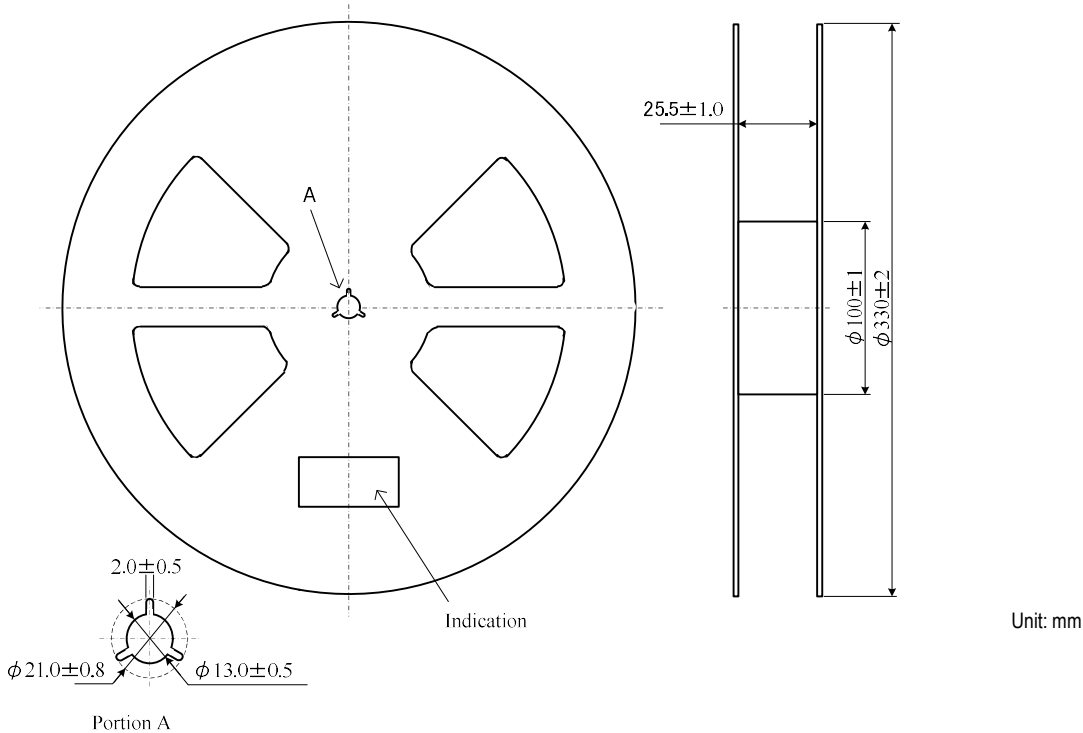

Figure 40. Reel Dimension

Tape Specifications

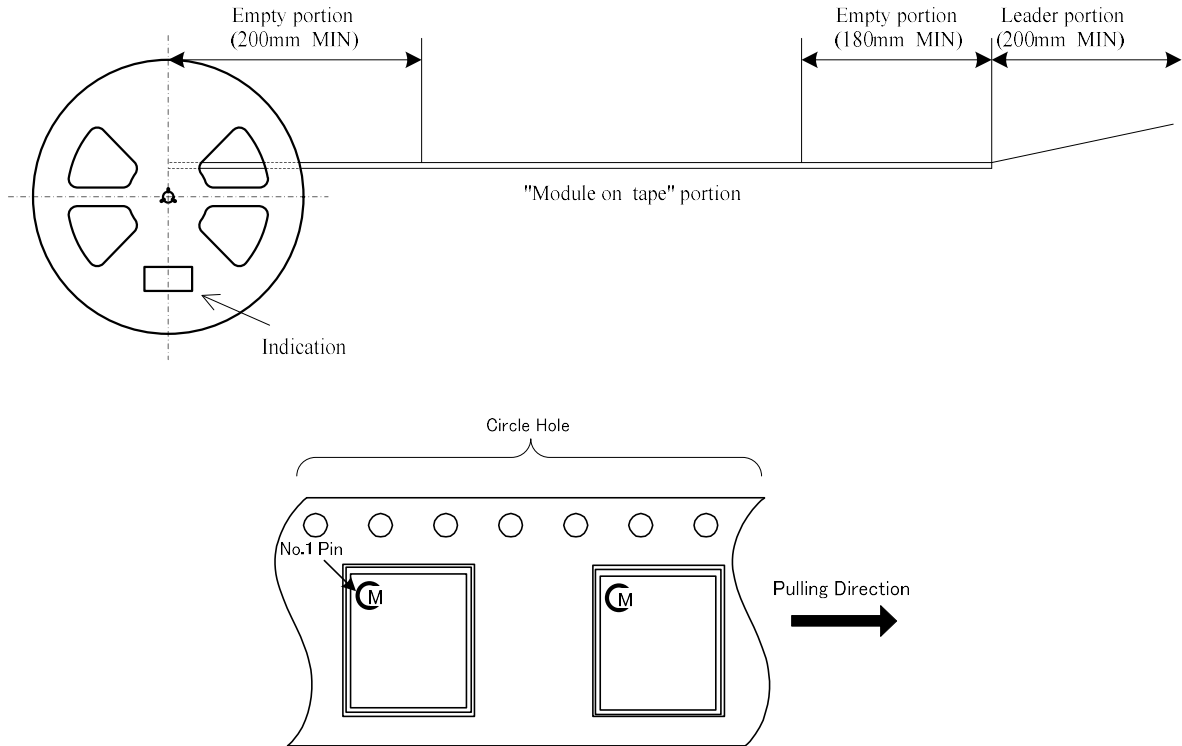

Figure 41. Tape Specifications

Notes

1. The adhesive strength of the protective tape must be within 0.3-1.0N.
2. Each reel contains the quantities such as the table below.
3. Each reel set in moisture-proof packaging because of MSL 3.
4. No vacant pocket in "Module on tape" section.
5. The reel is labeled with Murata part number and quantity.
6. The color of reel is not specified.

Soldering Guidelines

Murata recommends the specifications below when installing these converters. These specifications vary depending on the solder type.

Exceeding these specifications may cause damage to the product. Your production environment may differ therefore please thoroughly review these guidelines with your process engineers.

This product can be reflowed once.

Table 13. Reflow Solder Operations for Surface-Mount Products

For Sn/Ag/Cu BASED SOLDERS:	
Preheat Temperature	Less than 1degC per second
Time Over Liquidus.	45 to 75 seconds
Maximum Peak Temperature	245degC
Cooling Rate	Less than 3degC per second
For Sn/Pb BASED SOLDERS	
Preheat Temperature	Less than 1degC per second
Time Over Liquidus.	60 to 75 seconds
Maximum Peak Temperature	235degC
Cooling Rate	Less than 3degC per second

Recommended Lead-free Solder Reflow Profile

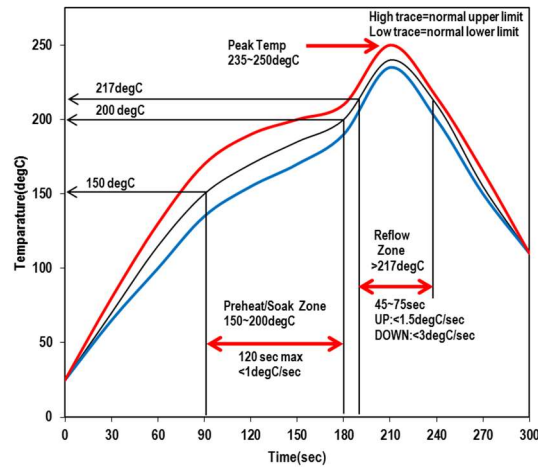
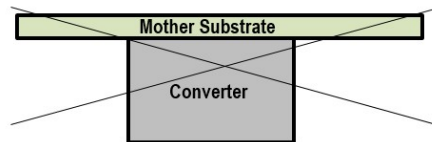

Figure 42. Recommended Lead-free Solder Reflow Profile

CAUTION: Do not reflow the converter as follows, because the converter may fall from the substrate during reflowing.



Pb-free Solder Processes

For Pb-free solder processes, the product is qualified for MSL 3 according to IPC/JEDEC standard J-STD-020D. During reflow PRODUCT must not exceed 245degC at any time.

Dry Pack Information

Products intended for Pb-free reflow soldering processes are delivered in standard moisture barrier bags according to IPC/JEDEC standard J-STD-033.

(Handling, packing, shipping and use of moisture/reflow sensitivity surface mount devices.)

Using products in high temperature Pb-free soldering processes requires dry pack storage and handling. In case the products have been stored in an uncontrolled environment and no longer can be considered dry, the modules must be baked according to J-STD-033.

Notices

Scope

This datasheet is applied to MYMGA5R03ECLA5RA and MYMGA5R03ECLA5RAD.
- Specific applications: Consumer Electronics, Industrial Equipment

CAUTION

Limitation of Applications

The products listed in the datasheet (hereinafter the product(s) is called the “Product(s)”) are designed and manufactured for applications specified in the specification or the datasheet. (hereinafter called the “Specific Application”). We shall not warrant anything in connection with the Products including fitness, performance, adequateness, safety, or quality, in the case of applications listed in from (1) to (11) written at the end of this precautions, which may generally require high performance, function, quality, management of production or safety. Therefore, the Product shall be applied in compliance with the specific application.

We disclaim any loss and damages arising from or in connection with the products including but not limited to the case such loss and damages caused by the unexpected accident, in event that (i) the product is applied for the purpose which is not specified as the specific application for the product, and/or (ii) the product is applied for any following application purposes from (1) to (11) (except that such application purpose is unambiguously specified as specific application for the product in our catalog specification forms, datasheets, or other documents officially issued by us*).

- (1) Aircraft equipment
- (2) Aerospace equipment
- (3) Undersea equipment
- (4) Power plant control equipment
- (5) Medical equipment
- (6) Transportation equipment (such as vehicles, trains, ships)
- (7) Traffic control equipment
- (8) Disaster prevention / crime prevention equipment
- (9) Industrial data-processing equipment
- (10) Combustion/explosion control equipment
- (11) Application of similar complexity and/or reliability requirements to the applications listed in the above

For exploring information of the Products which will be compatible with the particular purpose other than those specified in the datasheet, please contact our sales offices, distribution agents, or trading companies with which you make a deal, or via our web contact form.

Contact form: <https://www.murata.com/contactform>

*We may design and manufacture particular Products for applications listed in (1) to (11). Provided that, in such case we shall unambiguously specify such Specific Application in specification or datasheet without any exception. Therefore, any other documents and/or performances, whether exist or non-exist, shall not be deemed as the evidence to imply that we accept the applications listed in (1) to (11).

Fail-Safe Function

Be sure to add an appropriate fail-safe function to your finished product to prevent secondary damage in the unlikely event of an abnormality function or malfunction in our product.

Please connect the input terminal by right polarity. If you mistake the connection, it may break the DC-DC converter. In the case of destruction of the DC-DC converter inside, over input current may flow. Please add a diode and fuse as following to protect them.

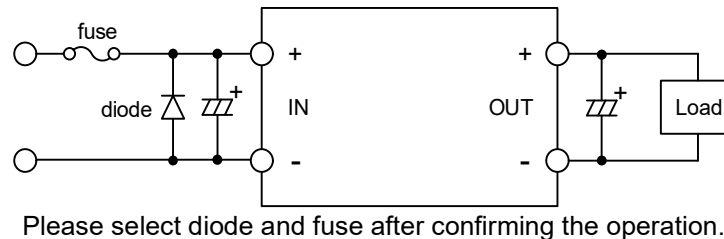

Please select diode and fuse after confirming the operation.

Figure 43. Circuit example with a diode and fuse



Note

1. Please make sure that your product has been evaluated in view of your specifications with our product being mounted to your product.
2. You are requested not to use our product deviating from the reference specifications.
3. If you have any concerns about materials other than those listed in the RoHS directive, please contact us.
4. Please don't wash this product under any conditions.

Product Specification

Product Specification in this datasheet are as of May 2023. Specifications and features may change in any manner without notice. Please check with our sales representatives.

Contact form

<https://www.murata.com/contactform?Product=Power%20Device>

Disclaimers

The information described in this data sheet was carefully crafted for accuracy. However this product is based on the assumption that it will be used after thoroughly verifying and confirming the characteristics and system compatibility. Therefore, Murata is not responsible for any damages caused by errors in the description of the datasheet.

Murata constantly strives improve the quality and reliability of our products, but it is inevitable that semiconductor products will fail with a certain probability. Therefore regardless of whether the use conditions are within the range of this data sheet, Murata is not responsible for any damage caused by the failure of this product., (for example, secondary damage, compensation for accidents, punitive damage, loss of opportunity, and etc.) Also, regardless of whether Murata can foresee the events caused by the failure of our product, Murata has no obligations or responsibilities.

The buyer of this product and developer of systems incorporating this product must analyze, evaluate, and make judgements at their own risk in designing applications using this product. The buyer and the developer are responsible for verifying the safety of this product and the applications, and complying with all applicable laws, regulations, and other requirements.

Furthermore, the buyer and developer are responsible for predicting hazards and taking adequate safeguards against potential events at your own risk in order to prevent personal accidents, fire accidents, or other social damage. When using this product, perform thorough evaluation and verification of the safety design designed at your own risk for this product and the application.

Murata assumes that the buyer and developer have the expertise to verify all necessary issues for proper use of the product as described above and to take corrective action. Therefore, Murata has no liability arising out of the use of the product. The buyer and developer should take all necessary evaluations, verifications, corrective actions and etc., in your own responsibility and judgment.

This data sheet does not guarantee or grant any license to the information, including patents, copyrights, and other intellectual property rights, of the Murata or third parties. Regardless of whether the information described in this datasheet is express or implied, Murata does not take any responsibility or liability for any claims, damages, costs, losses, etc. relating to intellectual property rights or other rights from third parties due to the use of these information.

Patent Statement

Murata products are protected to under one or more of the U.S. patents.

Copyright and Trademark

©2023 Murata Manufacturing Co., Ltd. All rights reserved.



This product is subject to the following [operating requirements](#) and the [Life and Safety Critical Application Sales Policy](#).

Refer to: <https://www.murata.com/products/power/requirements>

Murata Manufacturing Co., Ltd makes no representation that the use of its products in the circuits described herein, or the use of other technical information contained herein, will not infringe upon existing or future patent rights. The descriptions contained herein do not imply the granting of licenses to make, use, or sell equipment constructed in accordance therewith. Spec and cautions are subject to change without notice.