

1. Feature

1. High resistance value : 1Mohm to 1000Mohm
2. High operating voltage : Single Use 6.0kVdc max.
Molded Use 12.0kVdc max.
3. Narrow tolerance : +/-0.5% till 100Mohm
4. High reliability resistor : Usage Original resistor material



2. GENERAL

2.1 Application

This catalogue applies to the HIGH VOLTAGE RESISTOR used for High Voltage Power Supply.

Please contact us before using in the application of any other products.

2.2 Standard atmospheric test conditions

Unless otherwise specified, tests and measurements will be made under the standard conditions(Temperature : 5°C~35°C, relative humidity : 45%~85%).

If there may be any doubt on results, tests and measurements will be made under the following conditions, temperature : 25°C +/- 2°C, relative humidity : 65% +/- 5%.

If the test will be made under the special conditions, the measurement will be made leaving under the standard conditions for 1 hour to 2 hours.

3. RATING

3.1 Part numbering

<u>MHR</u>	<u>0614</u>	<u>S</u>	<u>A</u>	<u>○○○</u>	<u>△</u>	<u>□□</u>
1	2	3	4	5	6	7

1. High-Voltage Resistors

2. Substrate Dimensions (approximately : 6mm X 14mm)

3. Type (S : Standard type)

4. Circuit (A : One Resistor)

5. Resistance

The first and second figures are significant digits, and the third figure expresses the number of zeros which follow the two figures. (ex. 206=20M ohm)

(Value of standard step resistor : 10, 15, 20, 25, 30, 40, 50, 68, 80)

6. Resistance Tolerance (D:+/-0.5%,F:+/-1%,G:+/-2%,J:+/-5%,K:+/-10%,M:+/-20%)

7. Single Use : 70 Molded Use:20

3.2 Circuit



3.3 Rating Table

Standard step of resistance value	R-range	Tolerance	Maximum rated Voltage	Rated power
10,15,20, 25,30,40, 50,68,80	1M to 100M ohm	D:±0.5%	Single Use : 6.0 kVDC Molded Use :12.0kVDC	1.2W
	1M to 500M ohm	F:±1%		
	1M to 1000M ohm	G:±2%, J:±5%, K:±10%,M:±20%		

Notes) 1. Resistance value is single resistor value.

2. Resistance Value(R)·rated voltage(E)·rated power(P) will be calculated from the following formula.

$$E = \sqrt{P \times R} \quad \text{But, rated voltage (E) is less than above value.}$$

For example : $\sqrt{1.2W \times 10M\Omega} = 3.46kVDC$ (Maximum rated voltage)

When the rated voltage exceeds the maximum rated voltage, the maximum rated voltage will be the rated voltage.

4. GUARANTEE TEMPERATURE : -40°C to +125°C

When temperature exceeds 70°C, the rated power are derated according to the following curve.

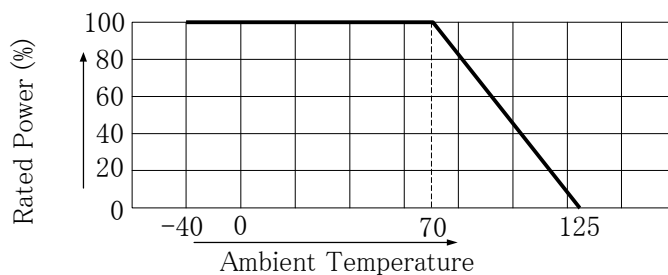

5. DIMENSION AND MARKING

5.1 DIMENSION

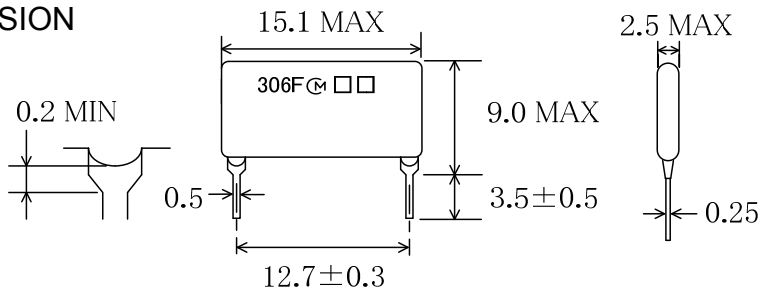

UNIT:mm

Notes) Marking side is opposite of electrode and resistor printed side.

5.2 MARKING

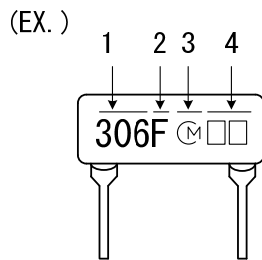

- 1. Nominal Resistance Value (3 digits)
- 2. Resistance Tolerance
- 3. Manufacture's Code
- 4. Date Code (Year, Month) ex. Made at 2017, Dec. = 7D

month	1	2	3	4	5	6	7	8	9	10	11	12
code	1	2	3	4	5	6	7	8	9	O	N	D

6. MECHANICAL CHARACTERISTICS

6.1 Terminal

The terminal connected securely to resistor with electrically and mechanically, and treat to solderable easily.

6.1.1 Terminal pull strength

The load of 10N will be applied to the terminal in its draw-out direction in 10 seconds +/- 1 seconds.

After pull test, there will be no break and defect in resistor.

6.1.2 Terminal bend strength

Bend the terminal by 90° in the vertical direction and return to the previous position under applying a load 5N. This operation is counted once. And repeat a similar operation in the opposite direction. This operation is counted twice.

One operation must be done in 5 seconds and repeated 4 times.

After bend test, there will be no break and defect in resistor.

6.1.3 Solderability of terminal

The terminal will be dipped into the methyl alcohol (10weight % ~ 15 weight.%) of rosin for 2 seconds to 3 seconds. And terminal will be dipped into the solder bath kept at 230°C +/- 5°C for 3 seconds +/- 0.5 seconds.

And then it will be lifted. Lifted speed is 25mm/s +/- 5mm/s.

After testing, a new uniform coating of solder will cover a minimum of 75% of the surface being immersed.

6.2 Resistance to solvents

After immersing in a isopropyl alcohol at 20°C ~ 25°C for 30 seconds +/- 5 seconds, raise it slowly.

After testing, no defect in resistor and not to disappear the marking.

6.3 Resistance to soldering heat

The terminal will be dipped into the solder bath kept at 260°C +/- 10°C for 10 seconds +/- 1 seconds.

The resistor will be stored at standard atmospheric conditions for 1 hour ~ 2 hours.

Dipped and lifted speed is 25mm/s +/- 5mm/s.

After testing, change of resistance will be satisfied table 1.

No defect in appearance and satisfied 6.1.1 and 6.1.2.

7. ELECTRICAL CHARACTERISTICS

7.1 Temperature coefficient of Resistance

Resistance value will be measured after stabilization at each sequence temperature for 30 minutes shown in table below. The measurement will be performed at the step 1 to 6 continuously.

The temperature coefficient of resistance will be calculated from the following formula. The step 2 and 3 will be based on the step 1, and the step 5 and 6 will be based on the step 4.

The change of resistance value at each temperature will be satisfied Table 1.

Step	1	2	3	4	5	6
Temp.(°C)	25±2	-15±2	-25±2	25±2	60±2	100±2

$$\text{TCR}(\text{ppm}/^{\circ}\text{C}) = \frac{R - R_0}{R_0} \times \frac{1}{t - t_0} \times 10^6$$

R = Actual measured resistance value (Ω) at $t^{\circ}\text{C}$.

R0 = Actual measured resistance value (Ω) at $t_0^{\circ}\text{C}$.

t = Actual measured value of test temperature.($^{\circ}\text{C}$)

t0 = Actual measured value of standard temperature.($^{\circ}\text{C}$)

7.2 Voltage characteristics

In standard temperature silicone oil (or same quality liquid), resistance value will be measured at 1/10 of the rated voltage, and then at the rated voltage.

However the time of voltage application will be 3 seconds less.

And the voltage will not be applied more than once every 10 seconds.

R variation will be calculated according to the following formula.

The variation will be satisfied Table 1.

$$\Delta R = (R_s - R_0) / R_0 \times 100$$

R_s = Resistance measured at 1/10 rated voltage.

R₀ = Resistance measured at rated voltage.

7.3 Short time overload

In standard temperature silicone oil (or same quality liquid), the 1.5 times the rated voltage will be applied for 60 seconds ± 5 seconds according to the Fig 2.

The measurements of resistance value will be made after leaving under the standard conditions for 1 hour to 2 hours.

After testing, change of resistance value will be satisfied Table 1.

7.4 Pulse characteristics

In standard temperature silicone oil (or same quality liquid), resistors will be charged 10,000 pulses ± 300 pulses of the rated voltage every 6 seconds (on=1 second , off=5 seconds) as the Fig 1 test circuit.

After testing, change of resistance will be satisfied Table 1.

No defect in resistor.

7.5 Thermal shock

Resistors will be exposed to a low temperature of $-40^{\circ}\text{C} \pm 5^{\circ}\text{C}$ for 30 minutes ± 5 minutes. And then exposed to a high temperature of $+100^{\circ}\text{C} \pm 5^{\circ}\text{C}$ for 30 minutes ± 5 minutes.

This constitutes is 1 cycle. Cycles will be repeated 50 cycles.

After testing, change of resistance value will be satisfied Table 1.

No defect in appearance and clacks.

7.6 Humidity storage

Resistors will be exposed to $60^{\circ}\text{C} \pm 2^{\circ}\text{C}$ and relative humidity 90%~95% for 1000 Hours ± 12 hours. The measurements of resistance value will be made after leaving under the standard conditions for 1 hour to 2 hours.

After testing, change of resistance value will be satisfied Table 1.

No defect in appearance.

7.7 High temperature storage

Resistors will be exposed to a high temperature of $100^{\circ}\text{C} \pm 2^{\circ}\text{C}$ for 1000 hours \pm 12 hours. The measurements of resistance value will be made after leaving under the standard conditions for 1 hour to 2 hours.

After testing, change of resistance value will be satisfied Table 1.

No defect in appearance.

7.8 Low temperature storage

Resistors will be exposed to a low temperature of $-40^{\circ}\text{C} \pm 2^{\circ}\text{C}$ for 1000 hours \pm 12 hours.

The measurements of resistance value will be made after leaving under the standard conditions for 1 hour to 2 hours.

After testing, change of resistance value will be satisfied Table 1.

No defect in appearance.

7.9 Humidity load life

Resistors will be subjected to the rated voltage as the Fig 2 test circuit for 90 minutes followed by a pause of 30 minutes for 1000 hours \pm 12 hours at $40^{\circ}\text{C} \pm 2^{\circ}\text{C}$ and relative humidity 90%~95%. The measurements of resistance value will be made after leaving under the standard conditions for 1 hour to 2 hours.

After testing, change of resistance value will be satisfied Table 1.

No defect in appearance.

7.10 High temperature load life

Resistors will be subjected to the rated voltage as the Fig 2 test circuit for 90 minutes followed by a pause of 30 minutes for 1000 hours \pm 12 hours at $70^{\circ}\text{C} \pm 2^{\circ}\text{C}$.

The measurements of resistance value will be made after leaving under the standard conditions for 1 hour to 2 hours.

After testing, change of resistance value will be satisfied Table 1.

No defect in appearance.

【 Table 1 Test specifications 】

No.	Test items	$\Delta R(\%)$
6.3	Resistance to soldering heat	$\pm 1\% \text{ MAX}$
7.1	Temperature coefficient of Resistance	$\pm 250 \text{ PPM}/^\circ\text{C}$
7.2	Voltage characteristics	$\pm 5\% \text{ MAX}$
7.3	Short time overload	$\pm 3\% \text{ MAX}$
7.4	Pulse characteristics	$\pm 3\% \text{ MAX}$
7.5	Thermal shock	$\pm 2\% \text{ MAX}$
7.6	Humidity storage	$\pm 3\% \text{ MAX}$
7.7	High temperature storage	$\pm 3\% \text{ MAX}$
7.8	Low temperature storage	$\pm 3\% \text{ MAX}$
7.9	Humidity load life	$\pm 4\% \text{ MAX}$
7.10	High temperature load life	$\pm 4\% \text{ MAX}$

Fig 1 Pulse test circuit

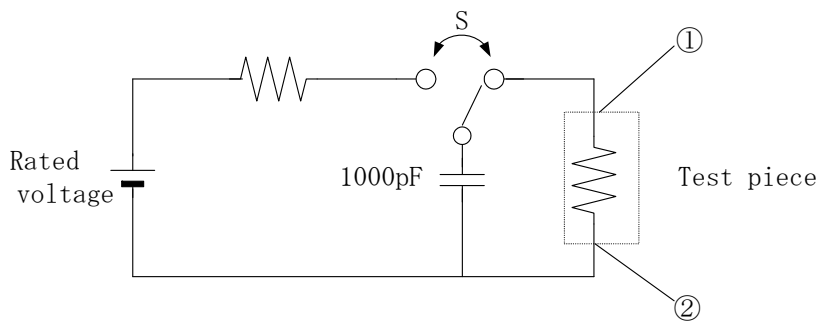
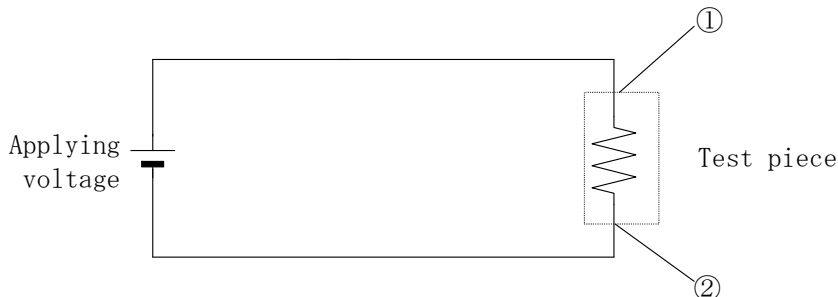

Fig 2 Applied voltage circuit



Notes) Applied voltage of section 7.3 will be $1.5 \times$ rated voltage.
Applied voltage of section 7.9 and 7.10 will be rated voltage.

8. STORAGE CONDITION

8.1 Storage temperature humidity

Resistors will be stocked under airtight or packed state with the following conditions.

Temperature	20°C±15°C
Humidity	Relative humidity 65%±20%

8.2 Storage circumstances

Resistors will not be stocked under corrosive gas (Cl₂, H₂S, NH₃, SO₂, NO_x, etc.) atmosphere to keep solderability of lead.

8.3 Storage period

Please use resistors within 6 month after delivery.

9. WARNING

9.1 Please consider following points in regards to reliability before use. If your consideration of designing is inadequate, there may happen unexpected phenomena.

Smoking and combustion may occur because of sparking between high voltage resistors and other electrode.

Temperature rising

Dielectric distance

Assembling position

Stain

9.2 Don't give high voltage resistors a shock in handling and on transport.

If high voltage resistors will be given a hard shock, dielectric material (Alumina substrate, dipping resin) may crack and dielectric strength may be down.

9.3 Limitation of applications

Please contact us before using our products for the undermentioned applications requiring especially high reliability in order to prevent defects which might directly cause damage to other party's life, body or property (listed below).

- (1) Aircraft equipment
- (2) Aerospace equipment
- (3) Undersea equipment
- (4) Nuclear control equipment
- (5) Medical equipment
- (6) Transportation equipment (automobiles, trains, ships, etc.)
- (7) Traffic signal equipment
- (8) Disaster prevention / crime prevention equipment
- (9) Data-processing equipment
- (10) Applications of similar complexity or with reliability equipments comparable to the applications listed in the above.

9.4 Notice in handling

9.4.1 Don't give high voltage resistors a shock in handling and on transportation.

If high voltage resistors will be given hand shock, lead wire bending may occur.

In such case high voltage resistors may be unable to be inserted to printed circuit board.

9.4.2 Be careful in handling to avoid adhering foreign matter. If foreign matter will adhere to lead wire, solderability may be down.

9.4.3 Please solder within resistance to soldering heat conditions, when high voltage resistors are soldered in your process. If soldering conditions will exceed above conditions, high voltage resistors have a risk to melt soldering parts or to make a crack of alumina substrate by means of heat shock.

9.4.4 When high voltage resistors are cleaned in your process, please confirm quality of high voltage resistors as your products.

9.4.5 When high voltage resistors are assembled in your products, be careful in handling to avoid breaking lead wire. If high voltage resistors will be handled in following condition, lead wire may be breaking.

Applying a load which exceeded specified value.

Bending or twisting many times.

Bending at sharp angle.

9.4.6 Do not bend the high voltage resistors after mounting and soldering.

If subjected to mechanical stress, the high voltage resistor may become damage.

9.4.7 Please be careful in handling not to get dirty on the surface of HIGH VOLTAGE RESISTOR. The dirty with ionic contents may be occurred resistance down at hightemp/humidity condition.

10. Note

10.1 Please make sure that your product has been evaluated and confirmed against your specifications when our product is mounted to your product.

10.2 Product catalogues are subject to change or our products in it may be discontinued without advance notice.

10.3 This catalogue is for reference only and not an official product specification document, therefore, please review and approve our official product specification before ordering this product.